

R3265A/3271A SERIES SPECTRUM ANALYZER

INSTRUCTION MANUAL

MANUAL NUMBER 0EA00 9404(A)

Applicable Instruments



R3265A	R3271A
R3365A	R3371A
R3265AP	R3271AP

The product is a Strategic Commodity subject to
COCOM regulations.

It should not be exported without the proper
authorization from Japanese government.

ADVANTEST CORPORATION

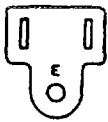
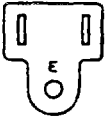
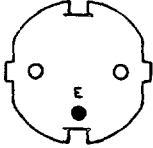
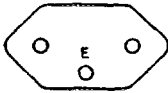
ADVANTEST provides the following power cables for each country.
 If there was any inconvenience on your use, please contact our
 subsidiaries or ADVANTEST representatives.

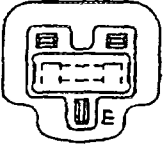
	Plugs	Standards/Countries	Ratings/Color/ Length	Accessory Codes
1		JIS : JAPAN	Rating :125V 7A Color :Black Length :2m	A01402 A01412
2		UL : USA CSA : CANADA	Rating :125V 7A Color :Black Length :2m	A01403 (Opt.95) A01413
3		CEE : EUROPE VDE : FRG OVE : AUSTRIA SEMKO : SWEDEN DEMKO : DENMARK KEMA : NETHERLANDS FIMKO : FINLAND NEMKO : NORWAY CEBEC : BELGIUM	Rating :250V 6A Color :Gray Length :2m	A01404 (Opt.96) A01414
4		SEV : SWITZERLAND	Rating :250V 6A Color :Gray Length :2m	A01405 (Opt.97) A01415
5		SAA : AUSTRALIA NEWZELAND	Rating :250V 6A Color :Gray Length :2m	A01406 (Opt.98)
6		BS : UK	Rating :250V 6A Color :Black Length :2m	A01407 (Opt.99) A01417

Note : "E" shows earth (ground).

PREFACE

All descriptions on the R3265A/3271A manual are also applicable to the R3365A/3371A.

Table of R3265A/3271A series-related manuals

Manual name	Contents	Remarks
(1) R3265A/3271A SERIES SPECTRUM ANALYZER INSTRUCTION MANUAL (THIS MANUAL)	Part 1: Explanation of accessories, panel, functions, operation, etc. Part 2: Performance test (Calibration), Adjustment	This manual is provided with the R3265A/3271A main unit.
(2) R3265A/3271A SERIES QUICK GUIDE	Explanation and examples of the R3265A/3271A.	This manual is provided with the R3265A/3271A main unit.
(3) R3265A/3271A SERIES CONTROLLER FUNCTION INSTRUCTION MANUAL	Part 1: Guide Part 2: Reference	This manual is provided with the R3265A/3271A Controller function.
(4) R3265A/3271A SERIES GPIB COMMAND EXTENDED FUNCTION INSTRUCTION MANUAL	Part 1: General - same contents as sections 6.1 and 6.2 in the instruction manual No. 1 shown above. Part 2: GPIB command expansion mode 1, supporting 8562 commands Part 3: GPIB command expansion mode 2, supporting 8566 commands	Sold separately.
(5) R3265A/3271A MAINTENANCE MANUAL	Introduction Specifications Performance test (Calibration) Adjustment Troubleshooting Replaceable mechanical parts Replaceable electrical parts, Location and circuit diagrams	Sold separately.

PART1

R3265A/3271A INSTRUCTION

TABLE OF CONTENTS

1. INTRODUCTION
 2. PANELS
 3. BASIC OPERATIONS
 4. MEASUREMENT EXAMPLES
 5. KEY FUNCTIONS
 6. GPIB : REMOTE PROGRAMMING
 7. SPLIT-SCREEN (2 SECTIONS) FUNCTION
 8. TROUBLESHOOTING
 9. THEORY OF OPERATION
 10. SPECIFICATIONS
- APPENDIX

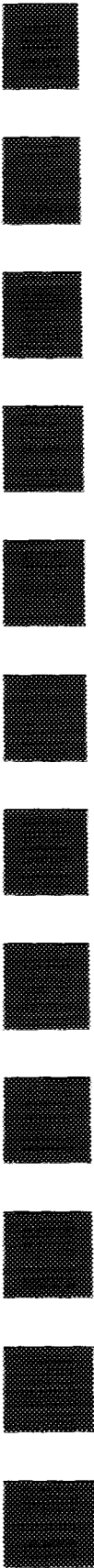

TABLE OF CONTENTS

1. INTRODUCTION	1-1
1.1 Outline of the Analyzer	1-2
1.2 Before You Use the Analyzer	1-4
1.2.1 Checking Accessories	1-4
1.2.2 Checking the Power Source	1-5
1.2.3 Operating Conditions	1-7
1.3 Storing, Cleaning, and Transporting the Analyzer	1-8
2. PANELS	2-1
2.1 Front Panel	2-2
2.2 Rear Panel	2-7
3. BASIC OPERATIONS	3-1
3.1 Panel Keys and Softkeys	3-2
3.2 Display	3-4
3.3 Basic Measurement Techniques	3-5
4. MEASUREMENT EXAMPLES	4-1
4.1 Measuring Frequencies	4-2
4.2 Measuring AM Signal Modulation Frequencies and Modulation Indexes	4-6
4.2.1 Measuring AM Signals With Low Modulation Frequencies and High Modulation Indexes	4-6
4.2.2 Measuring AM Signals With High Modulation Frequencies and Small Modulation Indexes	4-9
4.3 Measuring FM Signals	4-11
4.3.1 Measuring FM Signals With Low Modulation Frequencies and High Modulation Indexes	4-12
4.3.2 Measuring FM Signals With High Modulation Frequencies and Small Modulation Indexes	4-14
4.3.3 Measuring FM Signal Peak Shifts (Δf_{peak})	4-15
4.3.4 Measuring Small FM Modulation Indexes	4-16
4.4 Measuring Pulse-modulated Signals	4-18
4.5 Measuring Occupied Bandwidths (OBW)	4-20
4.6 Measuring Adjacent Channel Leak Power (ADJ)	4-23
4.7 Analyzing Burst Signal Spectra	4-28
4.8 Measuring with Tracking Generator (R3365A/3371A only)	4-29
4.8.1 Examples of Amplitude-frequency Characteristic Measurement	4-29

4.8.2 Examples of Amplitude-flatness Characteristics Measurement	4-38
4.8.3 Caution on Operations of Tracking Generator	4-43
5. KEY FUNCTIONS	5-1
5.1 Basic Key Functions	5-2
5.1.1 Center Frequency	5-2
5.1.2 Frequency Span	5-8
5.1.3 Start and Stop Frequency	5-11
5.1.4 Reference Level	5-12
5.1.5 Coupling Functions	5-14
5.1.6 Menu Keys	5-20
5.2 Trace Section Functions	5-27
5.3 Marker Section Functions	5-33
5.3.1 Marker ON	5-33
5.3.2 Peak Search	5-43
5.3.3 Marker → (Marker to)	5-49
5.3.4 Marker OFF	5-50
5.3.5 Multi Marker Function	5-51
5.4 User-Defined Softkey Functions	5-56
5.5 Memory Card Functions	5-60
5.5.1 Initializing the Memory Card and Saving or Recalling Custom Menus	5-60
5.5.2 Saving Internal Back-up Memory Data to the Memory Card	5-64
5.5.3 How to Handle a Memory Card	5-66
5.6 Save and Recall Functions	5-69
5.6.1 Save Function	5-70
5.6.2 Recall Function	5-79
5.7 Preset and Last State Functions	5-83
5.7.1 Preset	5-83
5.7.2 Last State	5-84
5.8 Calibration Function	5-85
5.9 Plotter Functions	5-88
5.10 Label Function	5-96
5.11 EMC Function	5-99
5.12 Date Function	5-112
5.13 Utility Function	5-113
5.14 Measurement Window Function	5-117
5.15 Printer Output	5-122
5.16 Power Measurement Functions	5-126
5.17 Tracking Generator Functions (R3365A/3371A only)	5-135
5.18 Serial I/O Function	5-139
5.18.1 Specifications	5-140
5.18.2 Connection	5-143

5.18.3 Communication Port Setting	5-146
5.18.4 Message Format	5-152
5.18.5 Difference from the GPIB Remote Programming	5-152
5.18.6 Sample Programs	5-154
5.18.7 Data Communication Error	5-164
5.18.8 Control Character Code List	5-165
5.18.9 HP-BASIC Sample Programs	5-166
5.18.10 Exception Processing	5-168
5.19 Simulated Analog Display Function	5-169
5.19.1 Functional Explanation	5-170
5.19.2 GPIB remote programming	5-174
5.20 Limit Line PASS/FAIL Function	5-177
5.21 Adjacent Channel Leakage Power Measurement Function with Attached Root Nyquist Filter	5-184
5.22 Alternated Modulation Distortion Measurement Function	5-190
6. GPIB: REMOTE PROGRAMMING	6-1
6.1 Overview of the GPIB	6-2
6.2 GPIB Specifications	6-3
6.3 Initializing the Analyzer	6-7
6.3.1 Setting the Analyzer's GPIB Address	6-7
6.3.2 Defining the Delimiter	6-7
6.4 Command Syntax (Listener)	6-7
6.5 Query Syntax (Talker)	6-11
6.6 Inputting and Outputting Trace Data	6-14
6.7 Service Request (SRQ)	6-19
6.8 GPIB Codes	6-21
7. SPLIT-SCREEN (2 SECTIONS) FUNCTION	7-1
7.1 Outline of Split-Screen (2 Sections) Function	7-1
7.2 A/B Mode	7-3
7.3 ZOOM/F-domain Mode	7-6
7.4 TIME-domain/F-domain Mode	7-10
7.5 GATED/TIME-domain Mode	7-13
7.6 DELAYED/TIME-domain Mode	7-20
8. TROUBLESHOOTING	8-1
8.1 Inspection and Diagnosis	8-2

9. THEORY OF OPERATION	9-1
9.1 Block Descriptions	9-2
9.2 Block Diagram	9-4
10. SPECIFICATIONS	10-1
10.1 R3265A/3365A Specifications	10-2
10.2 R3271A/3371A Specifications	10-11
10.3 R3265AP/3271AP Specifications	10-20
APPENDIX	A-1
A.1 Glossary	A-1
A.2 Level Scalings	A-8
A.3 Menu Lists	A-9
A.4 List of Messages	A-18

LIST OF ILLUSTRATIONS

No.	Title	Page
1-1	Checking the Fuse	1-5
1-2	Power Cable Plug and Adapter	1-6
1-3	Operating Conditions	1-7
2-1	Front Panel	2-6
2-2	Rear Panel	2-9
3-1	Display	3-4
3-2	Wiring	3-5
3-3	Initial Screen (R3271)	3-5
3-4	Setting the center frequency	3-6
3-5	Setting the span	3-6
3-6	Peak Marker	3-7
4-1	Measuring Frequency With a Normal Marker	4-2
4-2	Measuring Frequency in Frequency Counter Mode	4-4
4-3	Measuring Frequency in Marker Counter Mode	4-5
4-4	Measuring an AM Signal	4-6
4-5	Modulation Frequency of the AM Signal	4-8
4-6	AM Modulation Index	4-8
4-7	AM Signal With a High Modulation Frequency and a Small Modulation Index	4-10
4-8	Side Band Level: Relationship Between the Carrier Level (ESB – EC) and the Modulation Index m (%)	4-10
4-9	Measuring an FM Signal	4-11
4-10	FM signal With Low Modulation Frequency	4-13
4-11	FM Signal With High Modulation Frequency and Small Modulation Index	4-14
4-12	FM Signal With Small Δf_{peak}	4-15
4-13	FM Signal With Large Δf_{peak}	4-16
4-14	FM Signal f_c and E_c	4-17
4-15	FM Signal f_{SB} and ESB	4-17
4-16	Pulse-modulated Signal	4-18
4-17	Measuring the OBW	4-21
4-18	Measuring the Adjacent Channel Leak Power (ADJ POINT)	4-25
4-19	Measuring the Adjacent Channel Leak Power (ADJ GRAPH)	4-27
4-20	Connecting with Through State	4-30
4-21	Connecting with DUT	4-31
4-22	Connecting with Through State	4-32
4-23	Trace of the feedthrough characteristic	4-33
4-24	Display the Display-line and the Trace	4-34

5.1-1	Center Frequency	5-2
5.1-2	Entering the External Mixer Correction Data	5-7
5.1-3	Frequency Span	5-8
5.1-4	Start and Stop Frequency	5-11
5.1-5	Reference Level	5-12
5.1-6	RBW: The Maximum IF Bandwidth That Can be Separated as Two Signals	5-14
5.1-7	VBW = 300kHz	5-15
5.1-8	VBW = 3kHz	5-15
5.1-9	SWP = AUTO (500ms)	5-16
5.1-10	SWP = 50ms	5-16
5.1-11	Triggering with an On-screen Marker	5-20
5.1-12	Setting the Squelch Level	5-23
5.2-1	Basic Waveform in VIEW Mode	5-28
5.2-2	Second Higher Harmonics in WRITE B	5-28
5.2-3	AVG = None	5-30
5.2-4	AVG = 31st	5-30
5.3-1	Normal Marker	5-34
5.3-2	Delta Marker	5-34
5.3-3	Noise/Hz Level Measurement	5-37
5.3-4	X dB Down	5-39
5.3-5	Executing Auto Peaking	5-41
5.3-6	Peak Search Screen	5-43
5.3-7	ΔX and ΔY Resolution	5-45
5.3-8	Setting ΔX and ΔY	5-45
5.3-9	NEXT PK when NORM is selected	5-46
5.3-10	NEXT PK when UP is selected	5-46
5.3-11	NEXT PK when LOW is selected	5-46
5.3-12	Listing in Ascending Order	5-47
5.3-13	Listing with NEXT PK RIGHT Specified	5-48
5.3-14	Setting MKR \rightarrow CF	5-49
5.3-15	Multi Marker Display	5-51
5.3-16	Multi Marker Listing	5-51
5.3-17	An Example of Delta Marker Listing	5-53
5.3-18	Example Listing with a Display Line	5-53
5.4-1	User-Defined Display	5-57
5.5-1	External View of the Memory Card	5-60
5.5-2	Inserting and Removing the Memory Card	5-61
5.5-3	Initializing the Memory Card	5-63
5.5-4	Memory Card Battery Replacement	5-67
5.6-1	List of Saved Data	5-70
5.6-2	Explanation of the List	5-71
5.6-3	Data in Detail	5-74
5.6-4	Entering the Title of the Saved Data	5-75

5.6-5	Selecting the Data Type to Be Saved	5-77
5.6-6	Listing the Initialization Data	5-78
5.6-7	Recall Data List	5-79
5.6-8	Recall Data in Detail	5-81
5.9-1	Plotter Connection	5-88
5.9-2	Example Dip Switch Setting	5-89
5.9-3	Plotter Operation Window	5-89
5.9-4	Plotter Error Message	5-94
5.10-1	Label Display	5-97
5.11-1	TR1722 Antenna Factor	5-100
5.11-2	Entering a Limit Line	5-102
5.11-3	The displayed waveform and limit line do not match	5-104
5.11-4	The displayed waveform and limit line match	5-104
5.11-5	The displayed waveform and limit line do not match	5-106
5.11-6	The displayed waveform and limit line match	5-106
5.11-7	Measuring the Power Source Terminal Voltage	5-110
5.13-1	Waveform to Determine the OBW	5-114
5.13-2	Adjacent Channel Leak Power in Graph	5-114
5.14-1	Initial Screen of the Measurement Window	5-117
5.14-2	Partial Sweep Within a Window	5-120
5.15-1	R3265A/3271A and Printer Connection Diagram	5-122
5.15-2	DIP Switch for Address Setting	5-123
5.15-3	Printing Precision Set at LOW (Normal Size)	5-125
5.15-4	Printing Precision Set at HIGH (Half Size)	5-125
5.16-1	Average Power Measurement	5-126
5.16-2	Average Power Density Measurement	5-127
5.16-3	Average Power Measurement in Measuring Window	5-130
6.1-1	GPIB Bus Configuration	6-4
6-2	GPIB Connector Pin Assignment	6-5
6-3	Signal Line Termination	6-5
6-4	Relation Between Screen Grid and Data Points	6-14
7-1	A/B Mode	7-3
7-2	Full-Screen Display	7-4
7-3	Split-Screen Display (A/B Mode)	7-4
7-4	Measurement Screen in A/B Mode	7-4
7-5	ZOOM/F-domain Mode	7-6
7-6	Full-Screen Display (ZOOM/F-domain Mode)	7-8
7-7	Split-Screen Display (ZOOM/F-domain Mode)	7-9
7-8	Measurement Screen in ZOOM/F-domain Mode	7-9
7-9	TIME-domain/F-domain Mode	7-10
7-10	Full-Screen Display (TIME-domain/F-domain Mode)	7-11

7-11	Split-Screen Display (TIME-domain/F-domain Mode)	7-11
7-12	Measurement Screen in TIME-domain/F-domain Mode	7-11
7-13	Connecting the GATED SWEEP	7-13
7-14	Full-Screen Display (GATED SWEEP OFF)	7-14
7-15	Split-Screen Display (GATED SWEEP OFF)	7-14
7-16	Split-Screen Display (GATED SWEEP ON)	7-14
7-17	Full-Screen Display (GATED SWEEP ON)	7-14
7-18	Full-Screen Display	7-18
7-19	Split-Screen Display (GATED/TIME-domain Mode)	7-19
7-20	Measurement Screen in GATED/TIME-domain Mode	7-19
7-21	DELAYED SWEEP Connection Diagram	7-20
7-22	Full-Screen Display (DELAYED SWEEP OFF)	7-21
7-23	Split-Screen Display (DELAYED SWEEP OFF)	7-21
7-24	Split-Screen Display (DELAYED SWEEP ON)	7-21
7-25	Full-Screen Display (DELAYED SWEEP ON)	7-21
7-26	Full-Screen Display	7-24
7-27	Split-Screen Display (DELAYED/TIME-domain Mode)	7-25
7-28	Measurement Screen in DELAYED/TIME-domain Mode	7-25
A-1	IF Bandwidth	A-1
A-2	Reference Level	A-2
A-3	Occupied Bandwidth	A-3
A-4	Spurious Response	A-4
A-5	Noise Sideband	A-5
A-6	Bandwidth Selectivity	A-6
A-7	Bandwidth Switching Accuracy	A-6
A-8	VSWR	A-7
A-9	Level Scalings	A-8

LIST OF TABLES

No.	Title	Page
1-1	Accessories	1-4
1-2	Power Supply Specifications	1-5
5.1-1	Center Frequency Display Resolution	5-3
5.1-2	Allowable External Mixer Frequency Bandwidths	5-5
5.1-3	Frequency Span Display Resolution	5-9
5.1-4	RBW Automatically Selected	5-15
5.1-5	Functions That Cannot Be Used in Digital IF	5-19
5.9-1	Compatible Plotters	5-88
5.9-2	Plotter Pen Assignments	5-95
5.11-1	The CISPR Specifications for RBW	5-101
5.15-1	Usable Printer	5-122
6-1	Analyzer GPIB Interface Codes	6-6
6-2	Delimiter Specification Codes	6-7
6-3	Trace Accuracy Commands	6-14
6-4	Service Request ON/OFF Codes	6-19
6-5	Status Register Bit Assignments	6-19
6-6	Examples of Data Entry (GPIB codes with asterisk)	6-67

1. INTRODUCTION

This chapter briefly describes the ADVANTEST R3265A/3271A Spectrum Analyzer and describes set up procedures and operating conditions for the analyzer. Be sure to read this chapter before using the analyzer.



1.1 Outline of the Analyzer

The R3265A/3271A series is a swept-tuned spectrum analyzer with an analog-to-digital section for displaying and analyzing data. It operates in the following frequency, input, and display ranges:

Frequency range:	100 Hz to 8.0 GHz (R3265A) 100 Hz to 26.5 GHz (R3271A)
Input range:	-140 dBm to +30 dBm (R3265A) -135 dBm to +30 dBm (R3271A)
Display range:	95 dB

Frequency range :	100 Hz to 8.0 GHz (R3265AP) 100 Hz to 26.5 GHz (R3271AP)
Dynamic range	
Signal to Distortion	
Harmonic :	500 MHz \leq f < 800 MHz ; 96dB
	800 MHz \leq f < 1.0GHz ; 101dB
	1.0 GHz to 3.6GHz ; 104dB
	> 3.5GHz ; 112dB (R3265AP)
	110dB (R3271AP)

In these ranges, the analyzer features a maximum resolution of 10 Hz, a residual FM (frequency modulation) of 3 Hzp-p, and a noise sideband of -112 dBc/Hz (at 10 kHz from the carrier). The analyzer is equipped with GPIB remote control and a memory card function for saving and recalling waveform data and panel settings.

The analyzer provides the following additional features:

- the ability to sweep over a wide frequency range: from 100 Hz to 26.5 GHz (for the R3271A) or from 100 Hz to 8 GHz (for the R3265A). The analyzer can also perform a log sweep over the range from 1 kHz to 1 GHz.
- high-frequency resolution of up to 10 Hz, which permits analysis of adjacent signals and spurious signals at high frequencies.
- a precise measurement mode that uses the analyzer's built-in reference crystal to measure with 1 Hz accuracy signals too weak to measure with a counter.
- a memory card that can store waveform and control settings.
- the ability to observe directly the electric field strength and the QP (quasi-peak) value.
- a digital memory CRT screen that displays signal traces without flickering. Digital memory also allows marker functions for accurate and easy reading of trace values.
- a zero span mode that allows the analyzer to be set to a sweep time of 50μ s. This is useful for analyzing wave bursts and modulation.
- two independent channels of digital memory for simultaneous display of two traces.
- computer-controlled operation using a GPIB command set.
- Using controller function enables to control (GPIB control) the analyzer and also the other units that are equipped with a GPIB connector.
- The analyzer is equipped with delay-sweep, gated-sweep, and 2 screen-display functions.
- R3265A/3271A analyzer can be remote-controlled by the GPIB codes of Hewlett-Packard 8562/8566.

1.2 Before You Use the Analyzer

Before you use the analyzer, check it and its accessories as described below. Make sure your power source conforms to the specifications in section 1.2.2 and that operating conditions are as specified in section 1.2.3.

1.2.1 Checking Accessories

When you first receive the analyzer, check for shipping damage or imperfections, and check that it has all the accessories listed in Table 1-1. If any part is damaged or missing, contact Advantest or the nearest support office at the addresses and phone numbers listed at the end of this manual. (When ordering additional accessories, be sure to specify the type code and stock number.)

Table 1-1 Accessories

Part Name	Specification		Quantity		Remarks
	Type Code	Stock No.	R3265A/3271A	R3365A/3371A	
Power cable	A01412	DCB-DD3130×01	1	1	
Input cable	MI-09	DCB-FF0392	1	2	
	MC-61	DCB-FF0383	1	1	
N-BNC conversion adapter	JUG-201A/V	JCF-AF001E×03	1	2	
Power fuse	21806.3	DFT-AA6R3A	2	2	
Memory card	MAC1101BAB	SEE-MAC1101BAB	1	1	
Instruction manual	-	JR3265A/3271A SERIES	1	1	Japanese version
	-	ER3265A/3271A SERIES			English version
Quick guide	-	JR3265A/3271A(Q)	1	1	Japanese version
	-	ER3265A/3271A(Q)			English version

1.2.2 Checking the Power Source

Before you turn the analyzer on, make sure the power source you use meets all specifications in this section.

CAUTION

The analyzer may be damaged if the power supply conditions listed in Table 1-2 are not satisfied.

The analyzer may be damaged if the fuse rating is not 6.3 A/250 V.

(1) Checking Power Requirements

The analyzer's power supply operates in both of two voltage ranges: 90 V to 132 V, or 198 V to 250 V. It automatically switches to accommodate the proper range.

Table 1-2 Power Supply Specifications

Input voltage	90 V to 132 V	198 V to 250 V
Frequency	48 Hz to 440 Hz	48 Hz to 66 Hz
Power consumption	400VA or below	

(2) Checking the Fuse

The analyzer's fuse is rated at 6.3 A/250 V for both the 90 V to 132 V range and the 198 V to 250 V range. The fuse is located in the rear panel power connector.

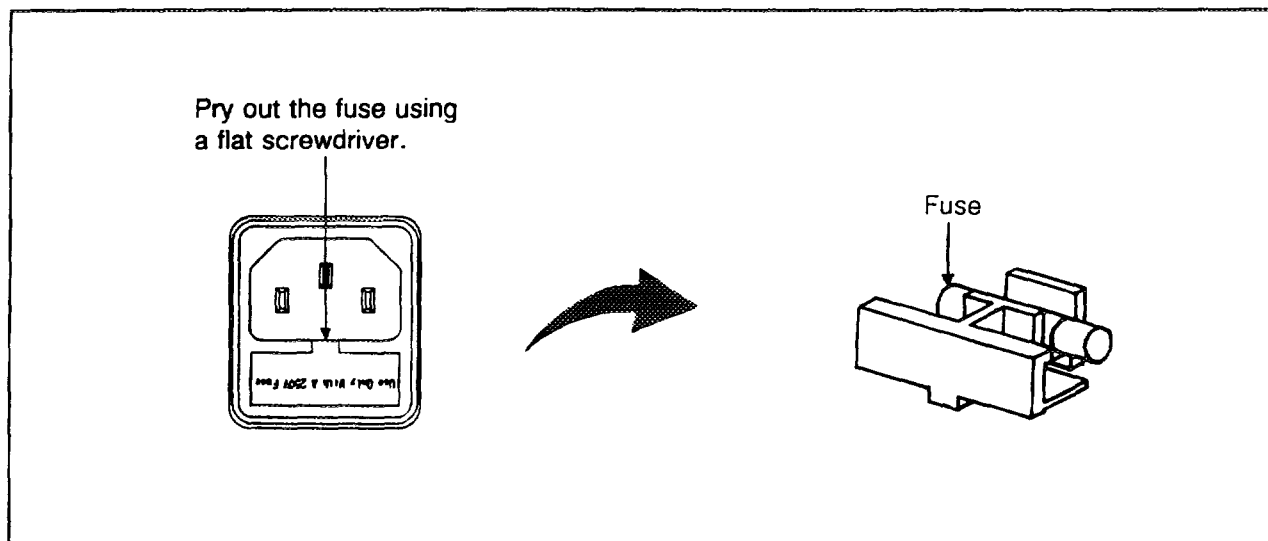

Figure 1-1 Checking the Fuse

(3) Checking the Power Cable

The standard power cable plug has three pins. For two-pin outlets, use a two-pin adapter and ground either the adapter's grounding lead or the grounding terminal on the analyzer's rear panel.

The two-pin adapter A09034 (KPR-18) conforms to industry standards. The adapter's pins have different widths as shown in Fig.1-3 (b). When inserting the adapter in the receptacle, be sure to orient it properly. If the A09034 will not go into the receptacle, use the optional adapter KPR-13.

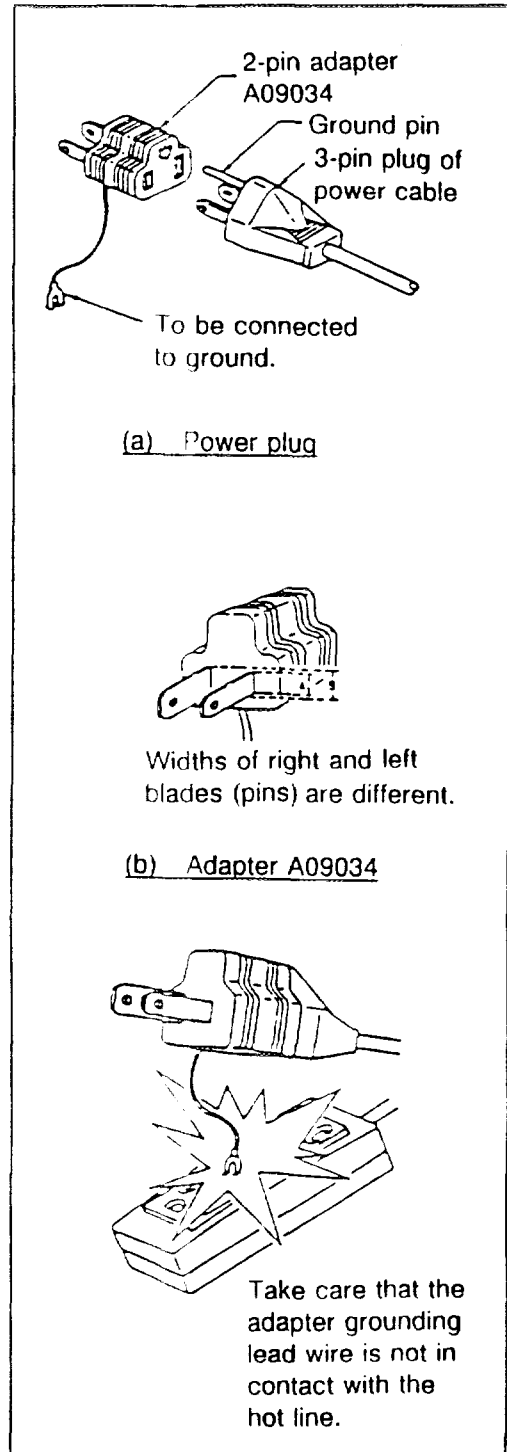

Figure 1-2 Power Cable Plug and Adapter

1.2.3 Operating Conditions

- (1) Keep the analyzer away from direct sunlight, dust, corrosive gases, and vibration.
- (2) Operate the analyzer only at temperatures between 32° F (0° C) and 122° F (50° C), and at a humidity below 85%.
- (3) The analyzer is designed to resist noise from AC power lines. However, you should still take steps to minimize power line noise. If necessary, install a noise suppressing filter in the analyzer's power supply.

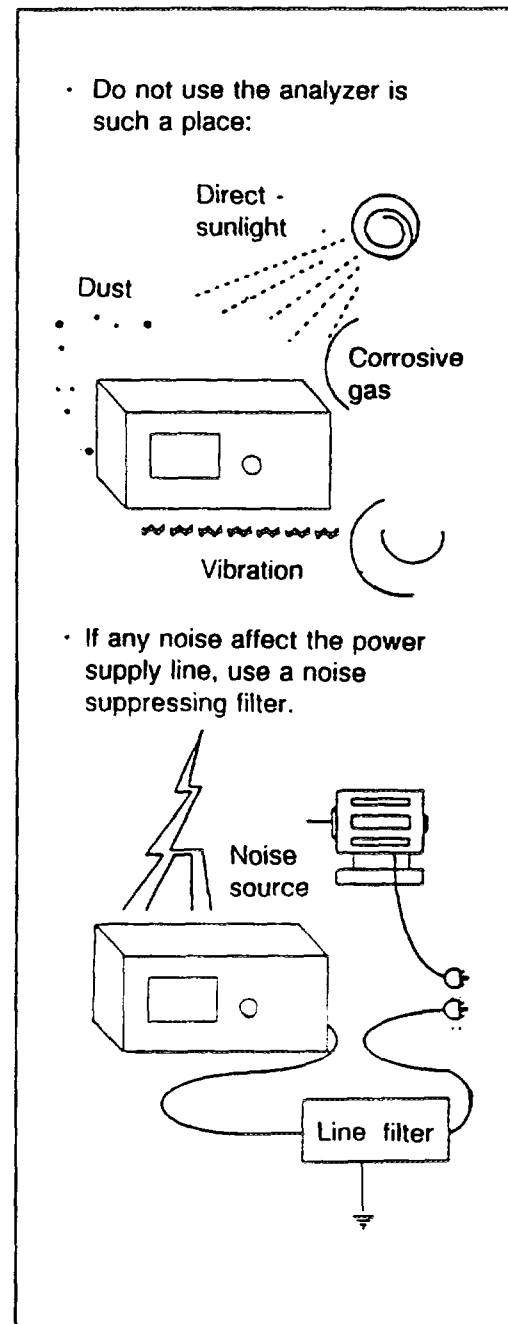

Figure 1-3 Operating Conditions

1.3 Storing, Cleaning, and Transporting the Analyzer

(1) Storing the Analyzer

Always keep the analyzer at temperatures between -4° F (-20° C) and 140° F (60° C). If the analyzer will not be used for a long time, wrap it in a vinyl cover or put it in a corrugated cardboard box in a dry place not exposed to direct sunlight.

(2) Cleaning the Analyzer's Display Screen

Clean the analyzer's anti-glare filter periodically with a soft cloth. Normally, you will only need to clean the filter surface. However, if the CRT display screen itself is dirty, remove the filter and clean the CRT with a soft cloth.

CAUTION

Never use cleaning solvents that affect plastic, such as benzene, toluene, or acetone.

(3) Transporting the Analyzer

If you need to transport the analyzer, pack it in its original packaging. If these materials aren't available, use a box made of corrugated cardboard at least 3/16 inch (5 mm) thick. Wrap the analyzer in shock absorbing material, place it in the box along with the accessories, and seal the box with packing tape.

2. PANELS

This chapter briefly describes the analyzer's front and rear panels.

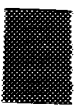

2.1 Front Panel

The front panel contains the following controls and connectors (refer to Figure 2-1). Access the keys labeled in blue by first pressing the shift key.

- ① Power switch : Supplies or cuts power.
- ② Memory card insertion slot
- ③ Eject button : Ejects the memory card.
- ④ DRIVE lamp : Lights while the memory card is operating.
- ⑤ INTENSITY knob : Adjusts the CRT brightness.
- ⑥ 1st Lo OUT connector : The output connector of the first block oscillator; connects to an external mixer. (This connector is not used in the R3265A.)
- ⑦ PHONE terminal : An 8Ω earphone jack for use with the receiver function. The analyzer also has an internal speaker.
- ⑧ PROBE POWER : Power source for accessories such as an active probe. The output current is ± 150 mA or below.

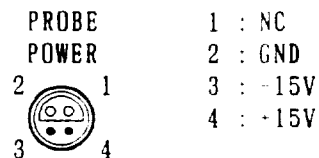

- ⑨ CAL OUT connector : Produces a -10 dB 25 MHz signal for automatic level calibration.
- ⑩ INPUT connector : N-type input connector. (The R3271A has an SMA to N-type adapter.)
- ⑪ CRT display : Displays waveforms and measurement data.
- ⑫ Softkey menu display section : Displays up to seven items.
- ⑬ Softkeys : Selects items from the softkey menu.

MAIN FUNCTIONS

- ⑭ CENTER FREQUENCY key : Lets you input the center frequency.
- ⑮ FREQUENCY SPAN key : Lets you input the frequency span.
- ⑯ START key : Lets you input the sweep starting frequency.
- ⑰ STOP key : Lets you input the sweep end frequency.
- ⑱ CPL (COUPLE) key : Lets you input the resolution bandwidth, video band width, sweep time, and input attenuation.
- ⑲ REFERENCE LEVEL key : Lets you input the reference level.
- Ⓚ MENU key : Selects trigger, detector, sweep, display line, or tracing menus.
- Ⓛ SWEEP lamp : Lights while a sweep is in progress.

TRACE Section

- Ⓜ A key
 - Ⓨ B key
 - # NORM key
- } : These keys control trace memory.
The LEDs light in every mode except VIEW and BLANK.
- : Lets you quickly normalize the display level.

GPIB Section

- Ⓩ LCL (LOCAL) key : Releases external control.
- Ⓛ REMOTE lamp : Lights while the analyzer is remotely controlled.
- # ADRS key : Lets you assign a GPIB address to the analyzer.

User-Defined Section

- | | | | |
|---|------------|---|--|
| Ⓜ | USER key | : | The function of this key can be defined by the user. |
| | DEFINE key | : | Defines the USER key function. |
| Ⓝ | RECALL key | : | Recalls previously saved settings. |
| | SAVE key | : | Saves the current settings. |
| Ⓜ | SHIFT key | : | Selects the shift mode for functions marked in blue above the key.(The LED lights when this mode is selected.) |
| Ⓜ | PRESET key | : | Initializes the analyzer. |
| # | LAST S key | : | Resets the analyzer to the settings it had just before the PRESET key was pressed. |

MARKER Section

- | | | | |
|---|----------------------|---|---|
| Ⓜ | ON key | : | Displays a marker for reading waveform data. |
| # | MULTI MKR | : | Displays up to eight markers. |
| Ⓝ | PEAK key | : | Shifts the marker to the waveform peak. |
| Ⓜ | MKR →(marker to) key | : | Saves the current marker values for use by other functions. |
| Ⓜ | OFF key | : | Deletes the marker. |

DATA Section	
⊗ Data knob	: Inputs data in jog mode.
⊗ Step keys	: Increments or decrements input data.
⊗ Numeric keypad	: Consists of numeric keys (0 to 9) and the decimal point key (.) for data input.
⊗ Back Space or minus (-) key	: Corrects input data. : Used for minus input.
⊗ Unit keys	: Selects a unit and enters the set value.
# CAL	: Calibrates the instrument.
# PLOT	: Prepares the analyzer for printing to an external plotter
# LABEL	: Creates a label for on-screen display.
# MEM CD	: Formats a memory card and stores menus and settings on the card.
# OPTION	: Reserved for future options.
# EMC	: Makes Electro-Magnetic Compatibility measurements.
# DATE	: Sets the date and time.
# UTIL	: Makes occupied bandwidth and adjacent channel leak power measurements.
# M W	: Sets up a measurement window to limit peak searches or the sweep.
# ENTER	: Enters numerical data.

CONTROLLER Section	
⊗ Controller function key	: Enables to use the controller function.
⊗ Controller stop/continue key	: Enables to stop or continue the controller function.

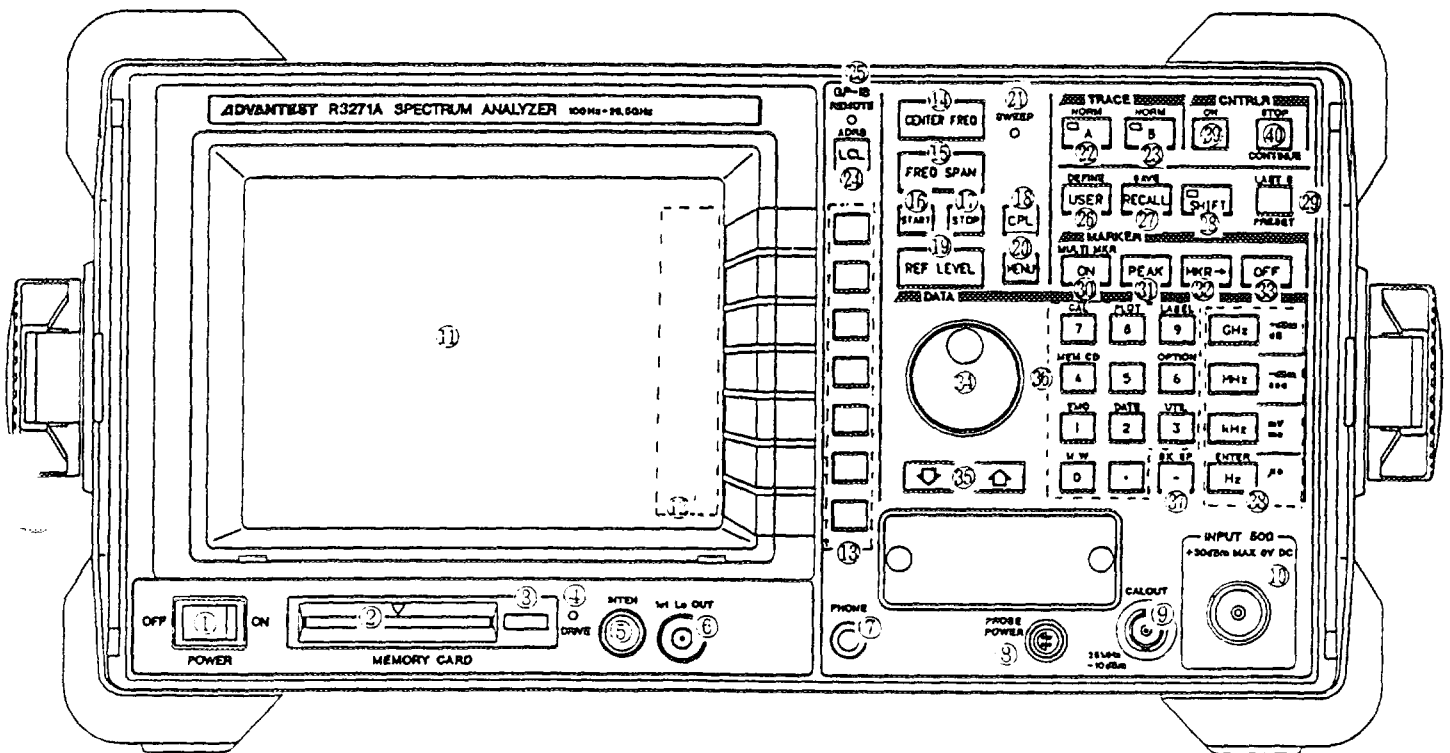

Figure 2-1 Front Panel

2.2 Rear Panel

The rear panel contains the following items (refer to Figure 2-2).

- ① SERIAL I/O
- ② GPIB connector : Connects the analyzer to an external controller and plotter using a GPIB cable.
- ③ Controller output terminal
- ④ X, 2V/nGHz output terminal : Outputs voltage in proportion to the sweep.
Output voltage: approx. -5 V to +5 V, or 2 V per GHz of tuning frequency.
Output impedance: approx. 1 k Ω .
- ⑤ Y output terminal : Outputs video signals in proportion to the trace vertical deflection.
Output voltage: approx. 0 V to 2 V.
Output impedance: approx. 220 Ω
- ⑥ Z output terminal : Outputs +5 V (TTL High level) while the spectrum analyzer is sweeping and 0 V (TTL Low level) during retrace. (Some plotters use these X, Y, and Z terminals; Z is for pen up/down.)
- ⑦ COMP VIDEO : Outputs to an external CRT display and VIDEO printer.
Output impedance: approx. 75 Ω (contains a 1VP-P composite signal).
- ⑧ External trigger : Receives an external triggering signal.
- ⑨ Gated sweep control terminal : Receives a signal that stops sweep and measurement at TTL Low level, and executes sweep and measurement at TTL High level.
- ⑩ 10 MHz Frequency Reference input/output terminal : Outputs or receives a 10 MHz reference frequency signal.
Output: approx. 0 dBm
Input: approx. -5 dBm to +5 dBm.

- ⑪ 21.4 MHz IF OUT : Outputs final IF (21.4 MHz) signals for access to the IF section for special applications.
Bandwidth resolution: bandwidth specified
Output level: approx. 0 dBm; at full scale on the CRT
Output impedance: approx. 50Ω.
- ⑫ 421.4 MHz IF OUT : Outputs 2nd IF (421.4 MHz) signals for pulsed measurements.
Output impedance: approx. 50Ω.
- ⑬ PARALLEL I/O : Parallel I/O connector
This connector is used when connecting the analyzer to the modulation accuracy measurement unit (R3541).
- ⑭ Warning Label
- ⑮ Installed options label
- ⑯ Warning Label
- ⑰ Cooling fan
- ⑱ AC power connector and fuse
- ⑲ Grounding terminal : Grounds the analyzer if the 3-pin power cable or the 2-pin adapter cannot be used.
- ⑳ Keyboard connector : Connects an external keyboard to the analyzer.

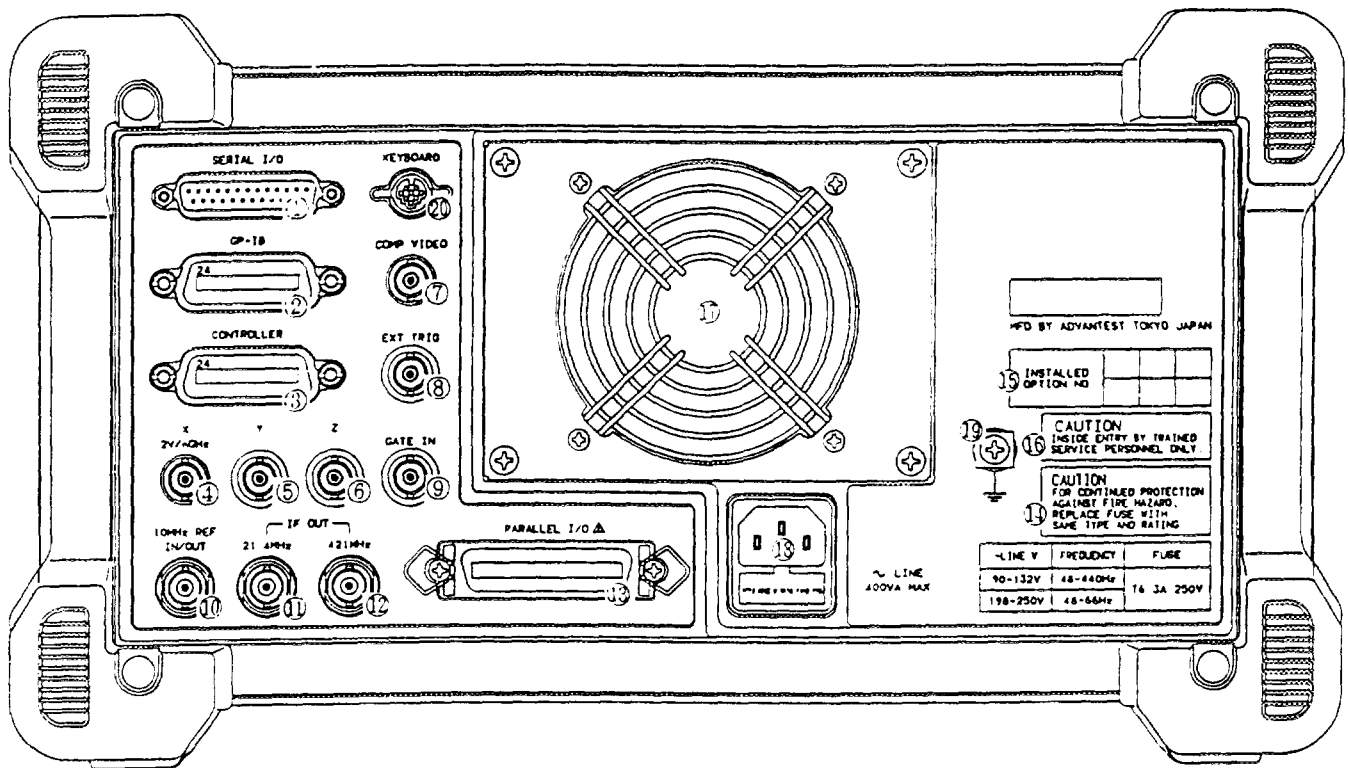

Figure 2-2 Rear Panel

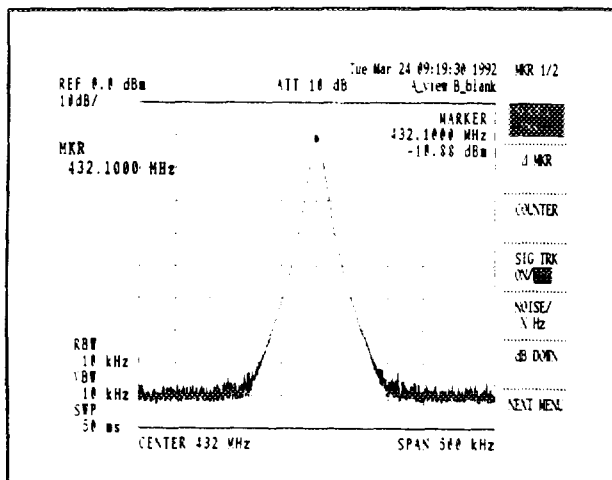

Figure 3-6 Peak Marker

- ⑥ Press **PEAK**. A marker appears at the waveform's peak. The frequency and the level at the marker position appear in the upper right corner of the screen. To remove the marker, press

OFF.

NOTE

To make the most accurate measurements possible, allow the analyzer to warm up for at least 30 minutes, and calibrate it as described in Section 5.8, Calibration Function, before making measurements.

3.3 Basic Measurement Techniques

This section gives an example of how to use the analyzer to measure the frequency and level of a typical signal. In this example, the signal is generated by a 430 MHz bandwidth oscillator.

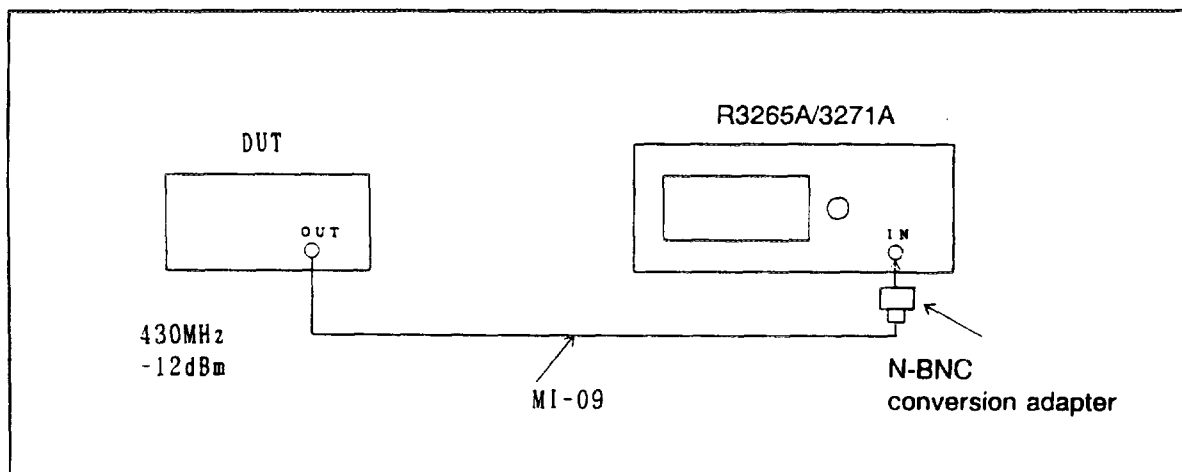

Figure 3-2 Wiring

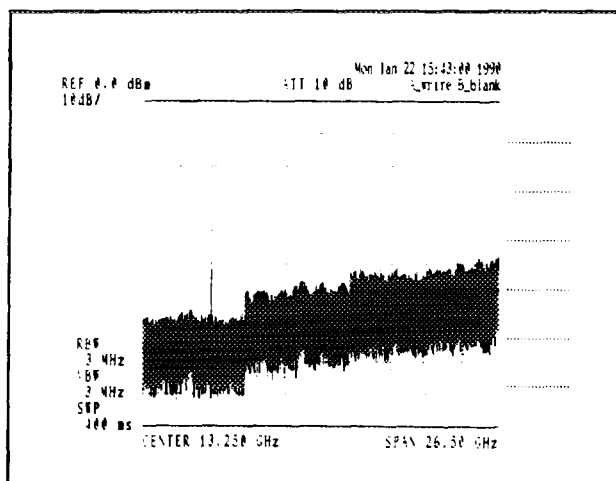



Figure 3-3 Initial Screen (R3271A)

Proceed as follows:

- ① Turn the power switch ON.
The analyzer runs a self check.
- ② Press the  key to initialize the analyzer. (Initializing returns the analyzer to its factory settings.)
- ③ Connect the analyzer to the signal source (the oscillator in this example) as shown in Figure 3-2.

WARNING

Do not exceed the maximum input level:

Maximum input level: +30 dBm

DC couple: 0 V

An input level exceeding these values will damage the analyzer's input mixer section and will require costly repairs. If there is a possibility that the input signal level may exceed the analyzer's maximum level, use an external attenuator to lower the signal level sufficiently.

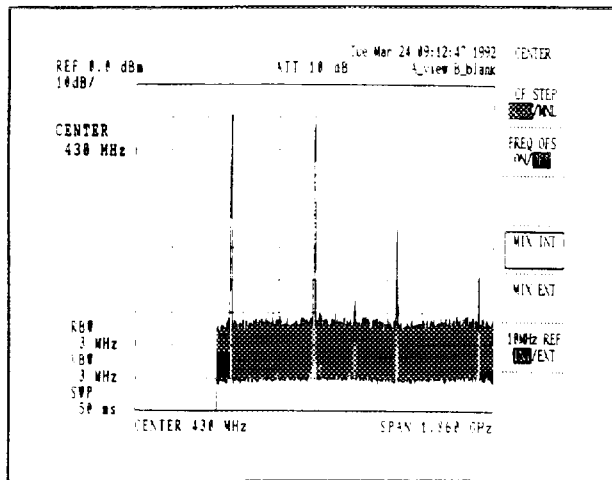

Figure 3-4 Setting the center frequency

④ Press **CENTER FREQ**

then press

4 **3** **0** **MHz** .

The signal appears at the center of the screen as shown in Figure 3-4.

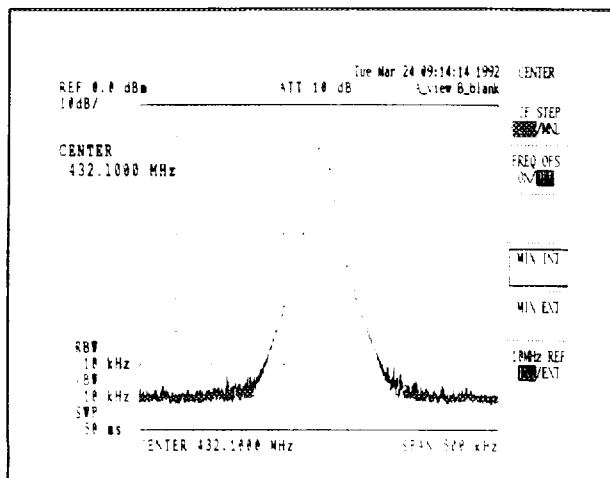

Figure 3-5 Setting the span

⑤ Press **FREQ SPAN** and

use the **↓** key to adjust the waveform for easy viewing.

If the center frequency shifts off-screen, press **CENTER FREQ** and use the knob to adjust the signal's position.

NOTE

When you modify the frequency span, the signal may shift from the screen center. In general, if you know the frequency of interest, use the numeric keypad to enter the frequency so that the waveform will not shift from the screen center when you set the span.

(3) Entering Data

Data can be entered in three ways.

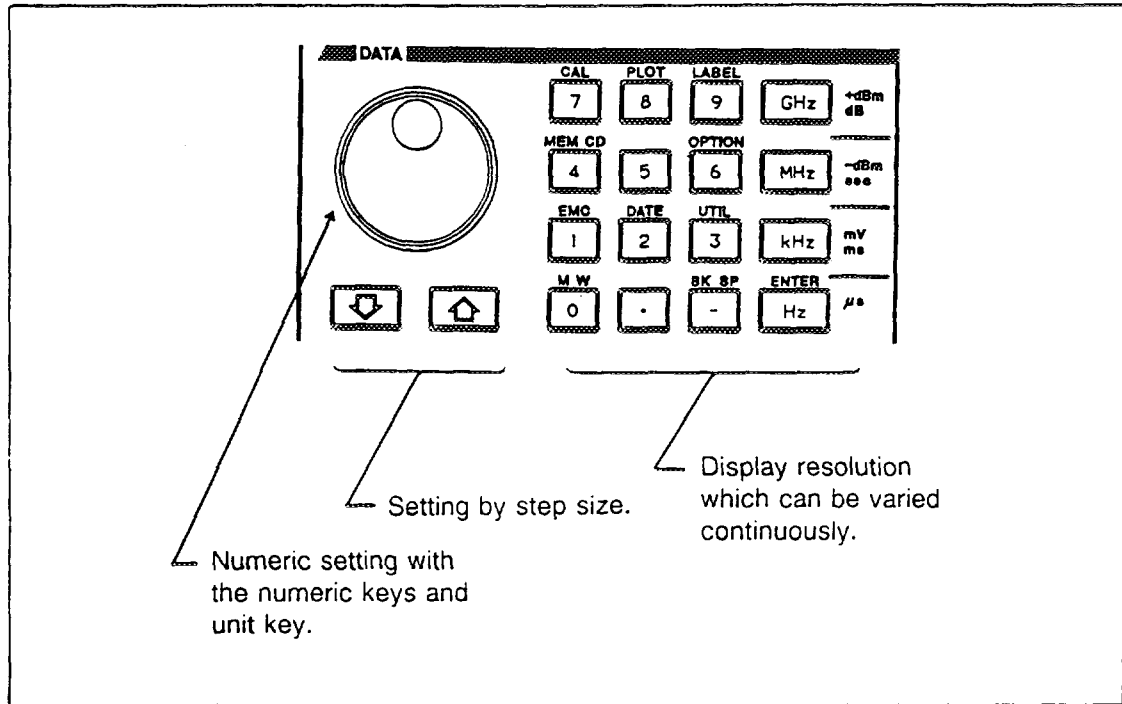

3.2 Display

Figure 3-1 describes the information that appears on the analyzer's display.

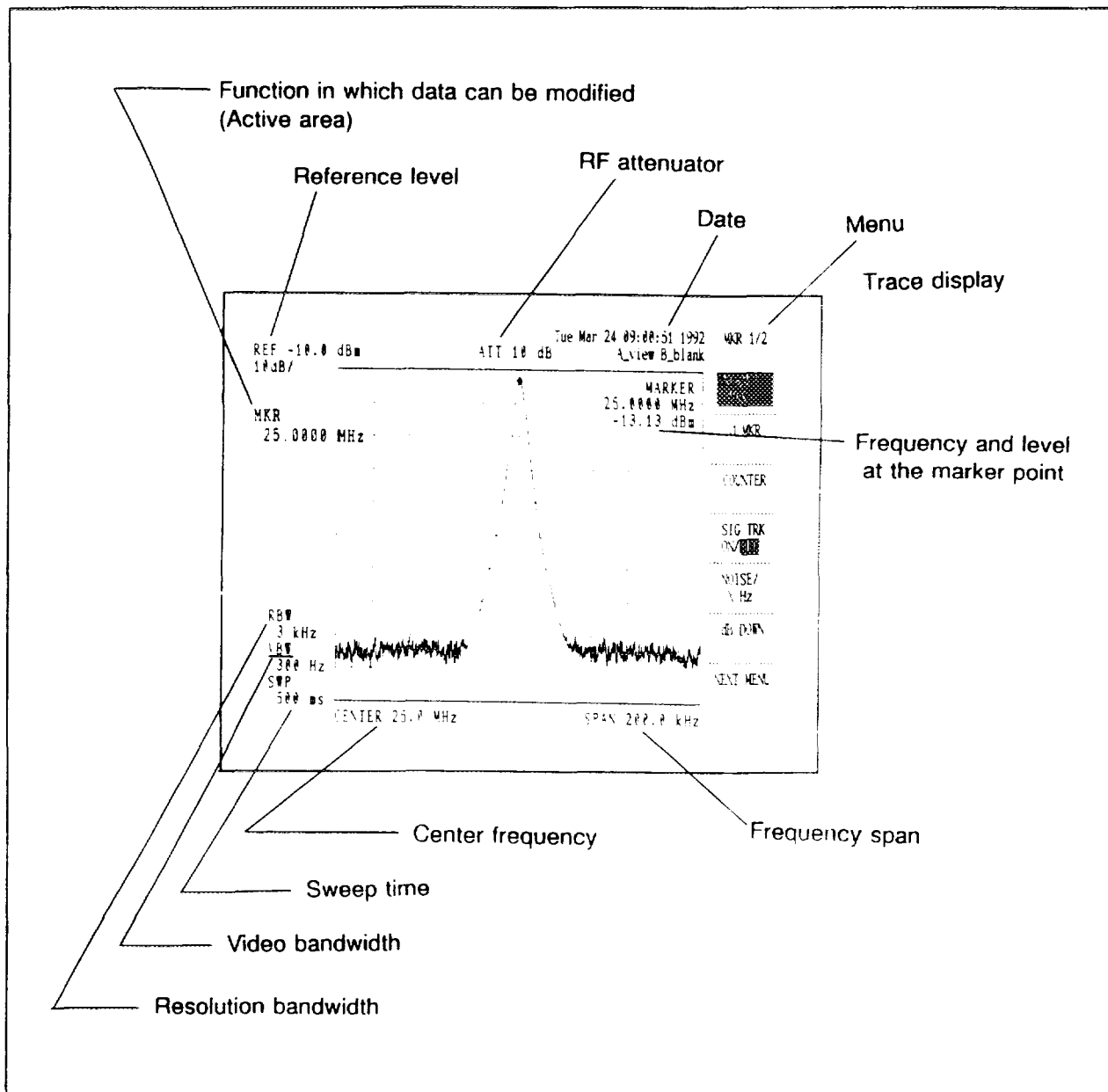

Figure 3-1 Display

3. BASIC OPERATIONS

This chapter explains the basic operations of the analyzer.

3.1 Panel Keys and Softkeys

Use the panel keys and softkeys to select the functions you want to use.

Note the following points regarding these keys.

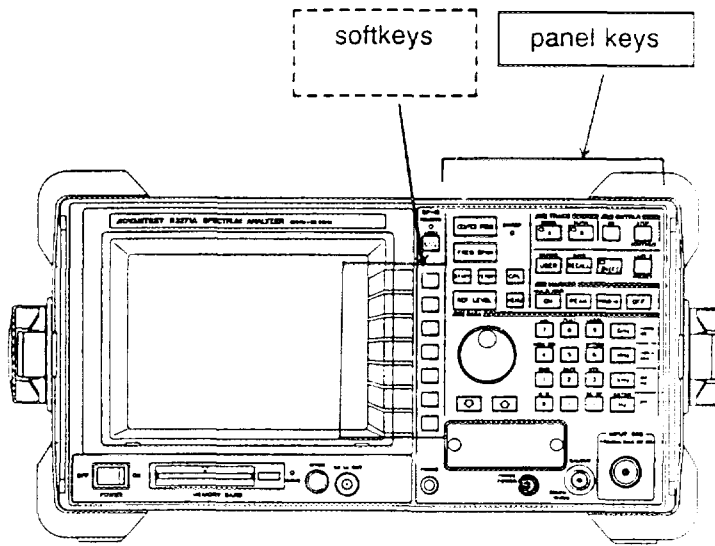

(1) Panel keys

To use the functions written in blue, first press the SHIFT. For example, press:

SHIFT MULTI MKR
ON to set the multi marker.

(2) Softkeys

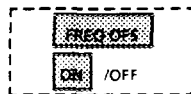

Some softkeys have selections that toggle every time the key is pressed.

The current selection appears in reverse video.

(3) Entering Data

Data can be entered in three ways.

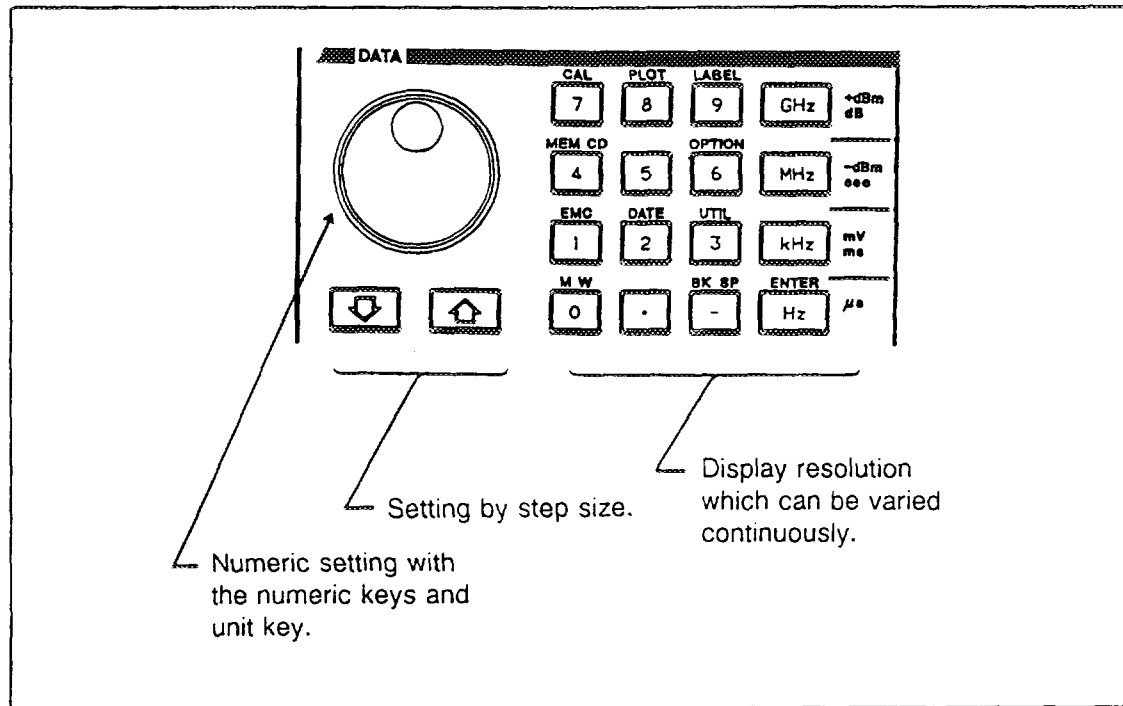

3.2 Display

Figure 3-1 describes the information that appears on the analyzer's display.

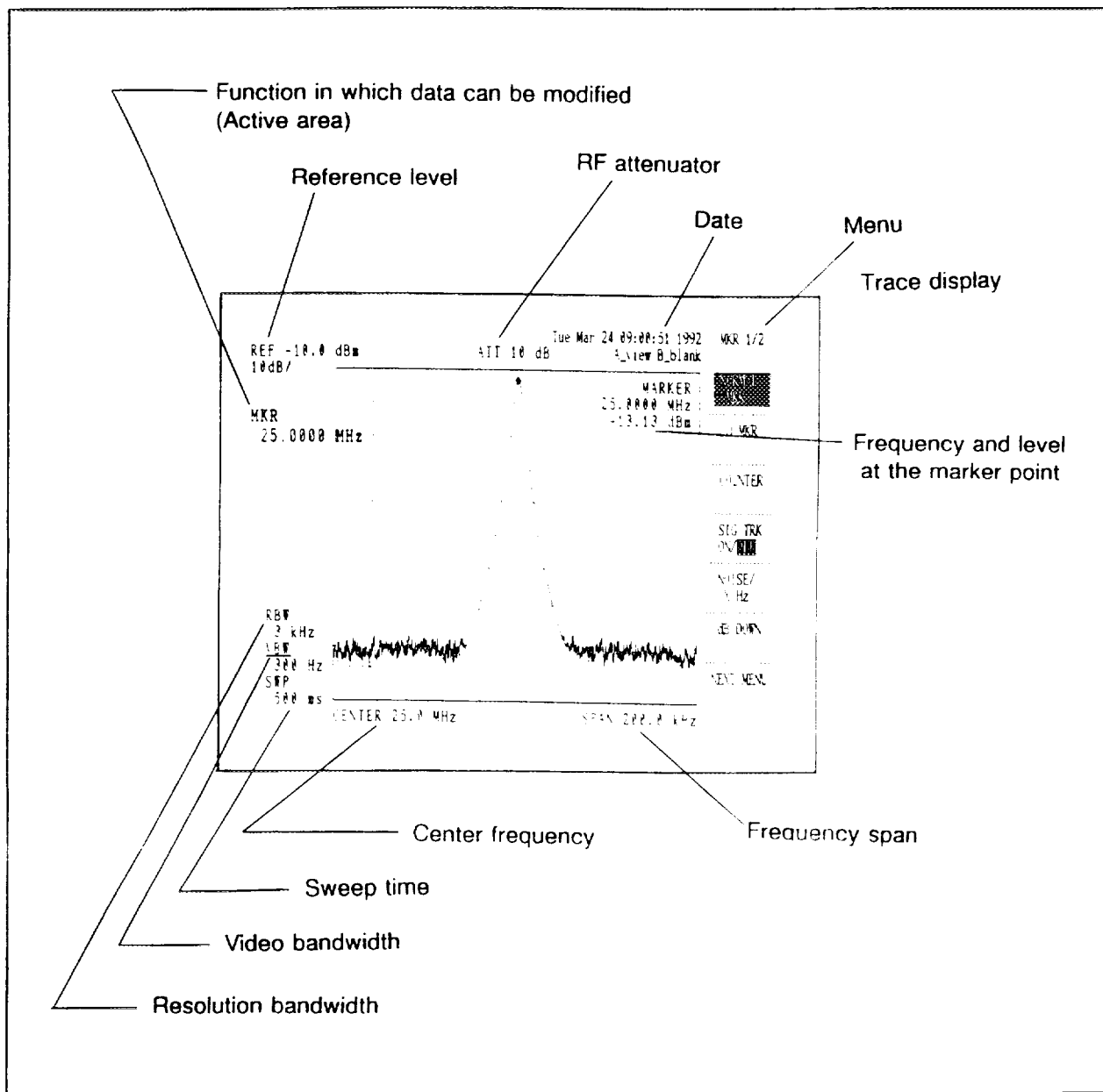

Figure 3-1 Display

3.3 Basic Measurement Techniques

This section gives an example of how to use the analyzer to measure the frequency and level of a typical signal. In this example, the signal is generated by a 430 MHz bandwidth oscillator.

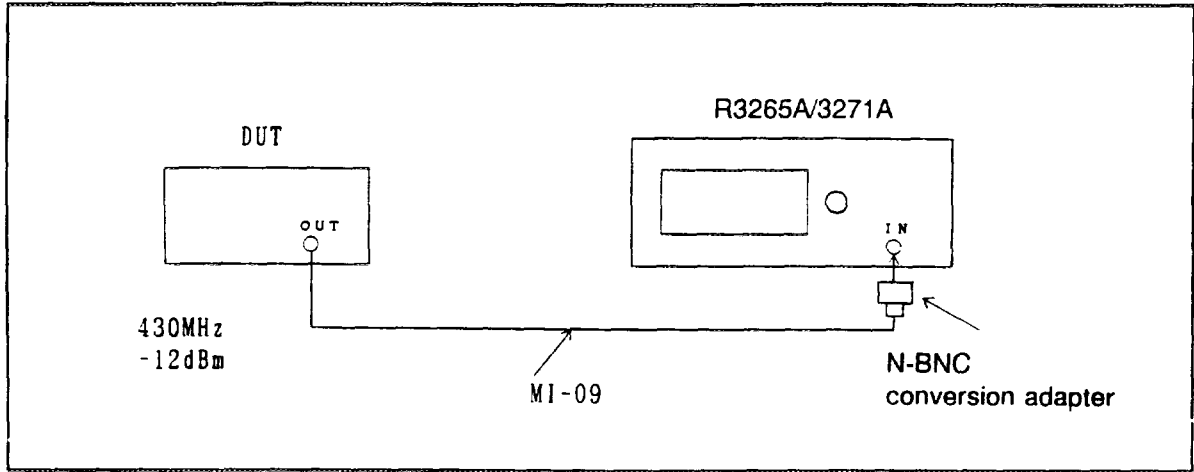

Figure 3-2 Wiring

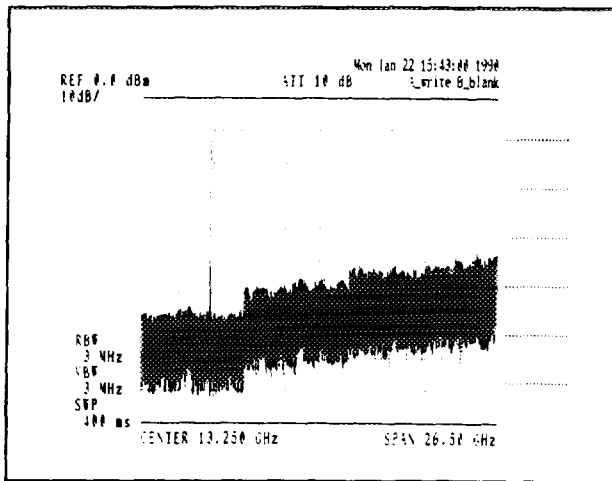



Figure 3-3 Initial Screen (R3271A)

Proceed as follows:

- ① Turn the power switch ON.
The analyzer runs a self check.
- ② Press the  key to initialize the analyzer. (Initializing returns the analyzer to its factory settings.)
- ③ Connect the analyzer to the signal source (the oscillator in this example) as shown in Figure 3-2.

WARNING

Do not exceed the maximum input level:

Maximum input level: +30 dBm

DC couple: 0 V

An input level exceeding these values will damage the analyzer's input mixer section and will require costly repairs. If there is a possibility that the input signal level may exceed the analyzer's maximum level, use an external attenuator to lower the signal level sufficiently.

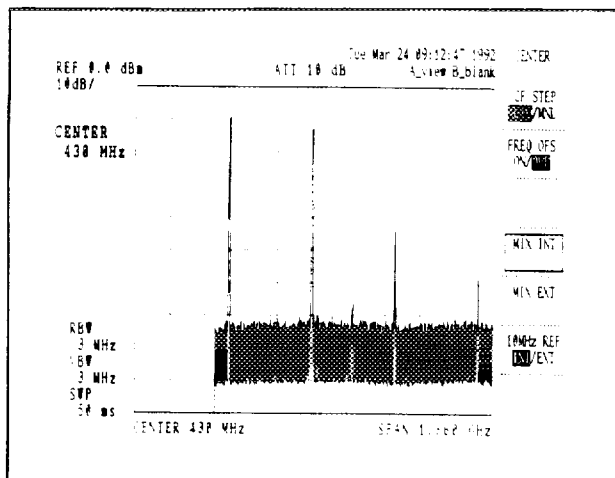

Figure 3-4 Setting the center frequency

④ Press **CENTER FREQ**

then press

4 **3** **0** **MHz** .

The signal appears at the center of the screen as shown in Figure 3-4.

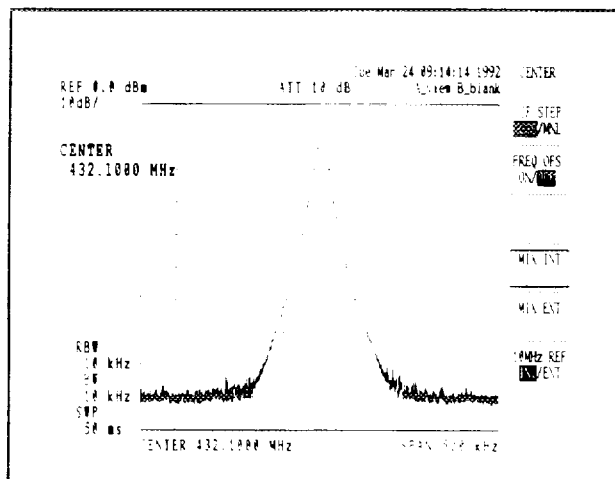

Figure 3-5 Setting the span

⑤ Press **FREQ SPAN** and

use the **↓** key to adjust the waveform for easy viewing.

If the center frequency shifts off-screen, press **CENTER FREQ** and use the knob to adjust the signal's position.

NOTE

When you modify the frequency span, the signal may shift from the screen center. In general, if you know the frequency of interest, use the numeric keypad to enter the frequency so that the waveform will not shift from the screen center when you set the span.

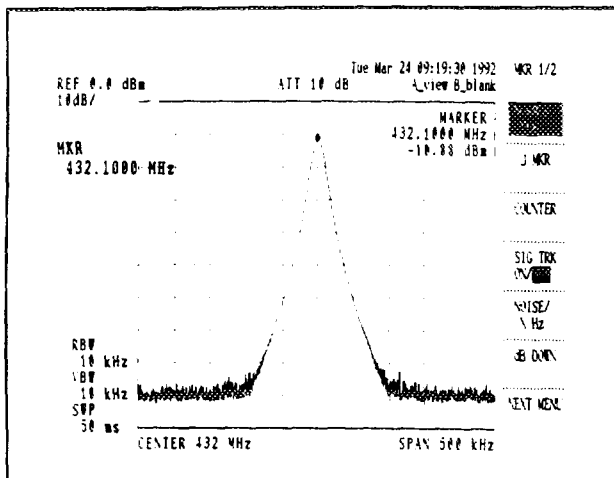

Figure 3-6 Peak Marker

- ⑥ Press **PEAK** . A marker appears at the waveform's peak. The frequency and the level at the marker position appear in the upper right corner of the screen.

To remove the marker, press

OFF .

NOTE

To make the most accurate measurements possible, allow the analyzer to warm up for at least 30 minutes, and calibrate it as described in Section 5.8, Calibration Function, before making measurements.

4. MEASUREMENT EXAMPLES

This chapter gives examples that show how to use the analyzer to make various measurements.

CAUTION

Before beginning each of the examples below, press PRESET to initialize the analyzer.
If necessary, feed input signals through an attenuator so that they are below the maximum input level, which is +30 dBm.

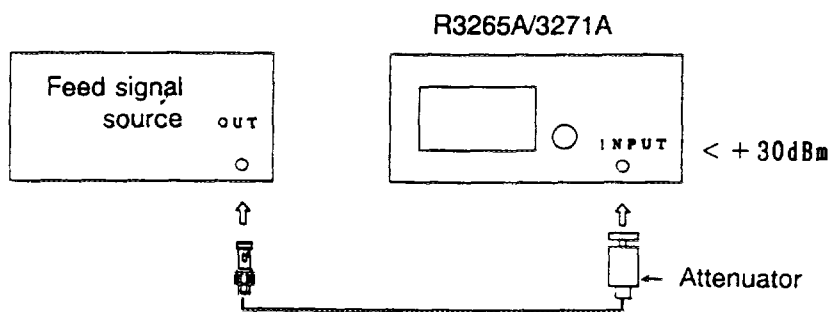

4.1 Measuring Frequencies

These examples demonstrate the measurement of a 200 MHz signal. You can measure frequency in three ways: using a normal marker, using the frequency counter mode, or using the marker counter mode. The normal marker only makes rough frequency measurements based on the display data. The frequency counter function lets you make precise frequency measurements using the analyzer's internal frequency counter. The marker doesn't have to be exactly at the signal's peak in this mode. The marker counter function lets you make precise frequency measurements exactly at the marker position.

(1) Measuring Frequency With a Normal Marker

The normal marker lets you make quick frequency measurements. Center and magnify the input signal, then turn on the peak marker as follows. In general, a smaller span improves accuracy.

- ① Press **CENTER FREQ** **2** **0** **0** **MHz**
- ② Press **FREQ SPAN** **1** **0** **0** **MHz**
- ③ Press **PEAK**

The marker frequency is displayed in the upper right corner of the screen.

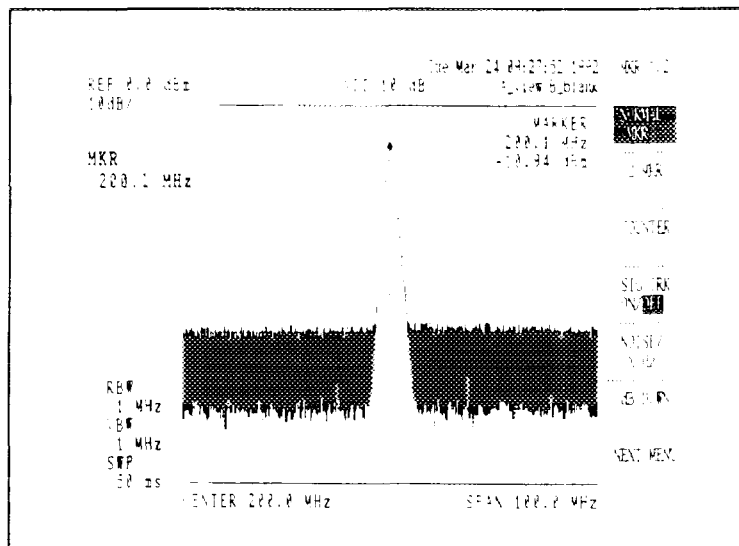

Figure 4-1 Measuring Frequency With a Normal Marker

Measurement Accuracy

$\pm (\text{Marker frequency} \times \text{Reference source accuracy}) + (\text{Span} \times \text{Span accuracy}) + (0.15 \times \text{Resolution bandwidth}) + 10 \text{ Hz}$

Span accuracy: $\pm 3\%$ (Span > 2 MHz)
 $\pm 5\%$ (Span \leq 2 MHz)

(2) Measuring Frequency in Frequency Counter Mode

Use this mode to make precision frequency measurements with the analyzer's internal frequency counter.

NOTE

1. The frequency counter mode may not operate correctly in the following cases:
 - Span > 1 GHz
 - The difference between the marker point and the signal level is 25 dB or below.
2. The frequency counter mode cannot be used with the signal track mode (described in section 5.3).

- ① Press MARKER ON

- ② Press COUNTER CNT RES
10HZ to set the measurement frequency resolution to 10Hz

- ③ Set **FREQ CNT** in FREQ CNT
/MKR CNT . This selects frequency counter mode.

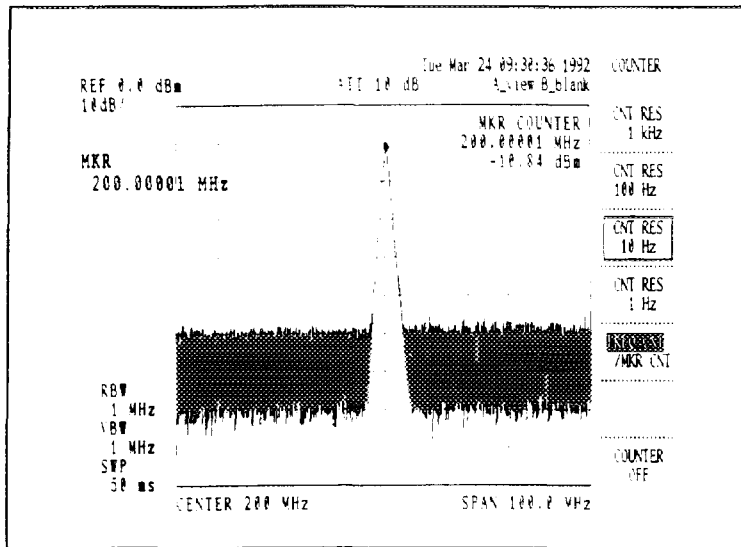

Figure 4-2 Measuring Frequency in Frequency Counter Mode

The marker frequency is displayed with 10Hz resolution at the upper right corner of the screen.

In this mode, the input signal frequency can be measured even if the marker point is not at the signal peak.

Measurement Accuracy

$$\pm (\text{Marker frequency reading} \times \text{Reference source accuracy}) + (5 \text{ Hz} \times N) + (\text{least sig. digit})$$

	Frequency Band	N: Mixer Degree
R3265A	0 to 8 GHz	N = 1
R3271A	0 to 7.5 GHz	N = 1
	7.4 GHz to 15.4 GHz	N = 2
	15.2 GHz to 23.3 GHz	N = 3
	23 GHz to 26.5 GHz	N = 4

(3) Measuring Frequency in Marker Counter Mode

Use this mode when the difference between the signal level and noise level (S/N) is 20 dB or less and the frequency counter cannot be used.

① Press **FREQ CNT/ MKR CNT** **MKR CNT** to set the counter mode to marker counter mode.

② Press **CPL** **SWP** and specify **1** **MHz** to increase the sweep time to 1 MHz.

The marker frequency is displayed with 10 Hz resolution at the upper right of the screen.

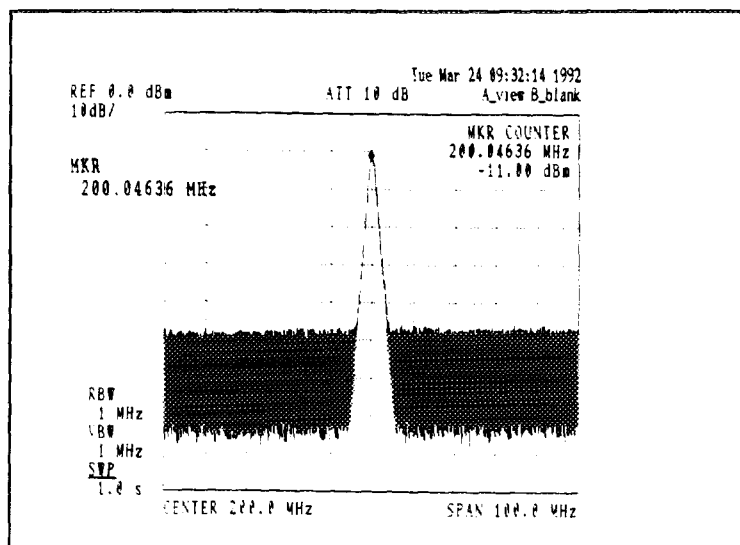

Figure 4-3 Measuring Frequency in Marker Counter Mode

Measurement Accuracy

Frequency counter mode accuracy + (Span x Sweep delay)

Sweep delay: approx. 1% (if the sweep time is AUTO)

4.2 Measuring AM Signal Modulation Frequencies and Modulation Indexes

The R3265/3271 can measure the modulation frequencies and indices of a wide range of AM signals.

To measure AM signals that have low modulation frequencies and high modulation indexes, use the analyzer in zero span mode in the time domain. The AM wave modulation index m is determined as follows (see Figure 4-4(a).):

$$m(\%) = (E_{max} - E_{min}) / (E_{max} + E_{min}) \times 100$$

To measure AM signals that have high modulation frequencies and low modulation indexes, use the spectrum analyzer in the frequency domain. Compare the side band to the carrier using this formula (see Figure 4-4 (b):

$$m(\%) = 2 E_{SB} / E_C \times 100$$

The spectrum analyzer can also accurately measure the modulation indexes of higher harmonics. The time domain method can determine modulation indexes only in the order of 2%, while the frequency domain method can determine them in the order of up to 0.02%.

Use LINEAR mode to measure modulation indexes of 10% or above, and use LOG mode to measure modulation indexes below 10%.

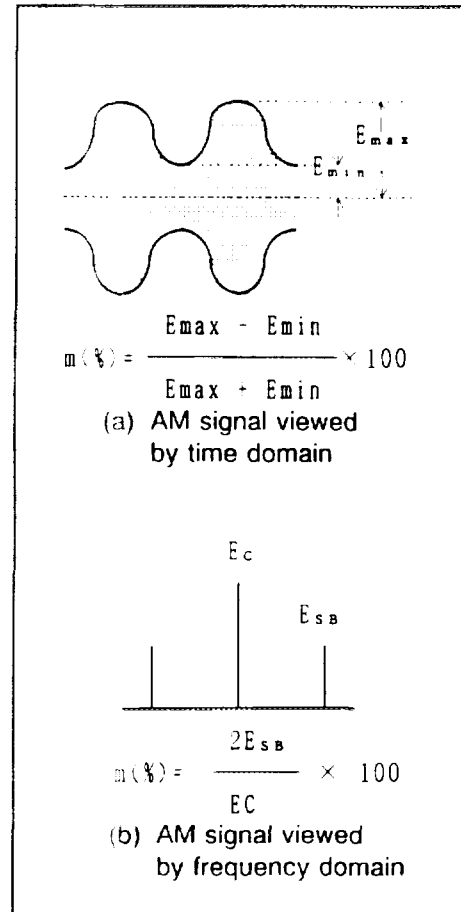

Figure 4-4 Measuring an AM Signal

4.2.1 Measuring AM Signals With Low Modulation Frequencies and High Modulation Indexes

Procedure

- ① Display the signal to be measured and match its peak to the reference level. (In this example the carrier frequency is 903 MHz.)

Press **CENTER FREQ** **9** **0** **3** **MHz** .

Press **FREQ SPAN** **2** **0** **MHz** .

Press **REF LEVEL** and use the data knob to place the signal's peak at the screen REF level.

4.2 Measuring AM Signal Modulation Frequencies and Modulation Indexes

- ② Set the resolution bandwidth to at least three times the modulation frequency.

Press CPL RBW ↑ .

- ③ Set the vertical scale to LINEAR mode.

Press REF LEVEL LIN .

- ④ Select zero span mode. This puts the analyzer's horizontal axis in the time domain.

Press FREQ SPAN ZERO SPAN .

- ⑤ Set the trace detection mode to SAMPLE.

Press MENU TRACE
DET SAMPLE .

- ⑥ Press REF LEVEL and use the data knob to move the signal level peak to the REF line.

- ⑦ Set the trigger mode to VIDEO.

Press MENU TRIGGER VIDEO and adjust the trigger level.

- ⑧ Set the sweep time to a value that makes observation easy.

Press CPL SWP and use the step keys to set the sweep time.

- ⑨ Use the delta marker to measure the interval between the modulation signal peaks (this is the period T).

Press PEAK ON △MKR and use the data knob to move the marker.

Press 1/△MKR
ON/OFF to select ON and display the modulation frequency.

- ⑩ Turn on the normal marker, set the marker at the waveform's maximum value, and write down the level E_{max} .

Press ON NORMAL
MKR .

- ⑪ Set the marker at the waveform minimum value and write down the level E_{min} . Use the data knob to set the marker at the waveform's minimum value.

⑫ Use the following expression to determine the modulation index m :

$$m (\%) = \frac{E_{max} - E_{min}}{E_{max} + E_{min}} \times 100 (\%)$$

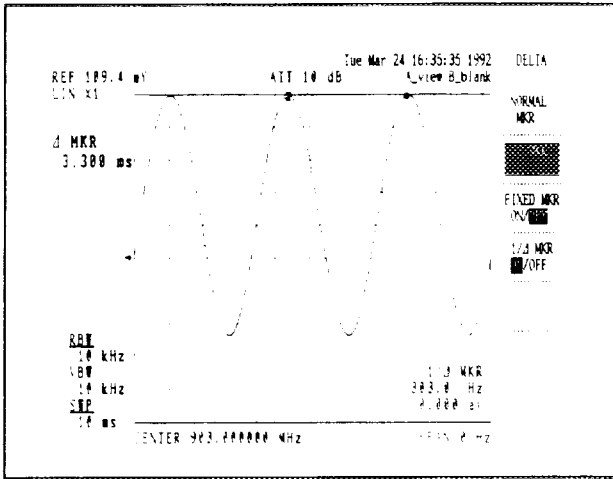

Figure 4-5 Modulation Frequency of the AM Signal

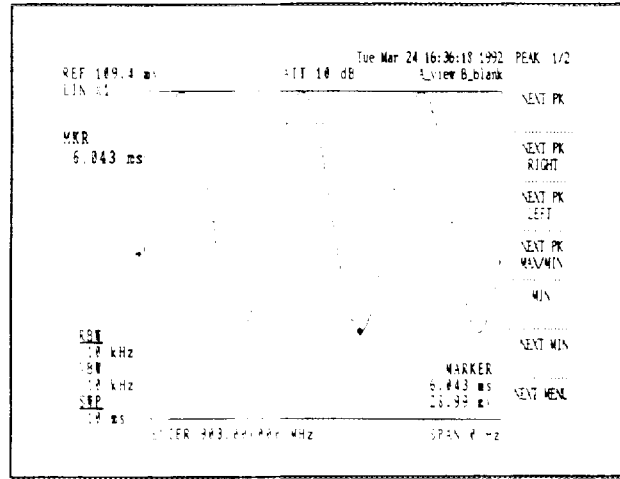

Figure 4-6 AM Modulation Index

4.2.2 Measuring AM Signals With High Modulation Frequencies and Small Modulation Indexes

Procedure

- ① Set the frequency span to a range between two and ten times the modulation frequency.

Press FREQ SPAN and use the step keys to set the span.

- ② Set the center frequency to the carrier frequency.

Press CENTER FREQ and use the data knob to set the center frequency.

- ③ Set the marker at the carrier peak.

Press PEAK

- ④ Place the delta marker on the modulation signal peak and write down $E_{SB} - E_c$.

Press ON △ MKR and use the data knob to position the delta marker.

- ⑤ Use the following formula to calculate the modulation frequency f_m and modulation index m .

f_m = Delta marker frequency

$$m = \log^{-1} \frac{E_{SB} - E_c + 6}{20}$$

Figure 4-8 shows the relationships between $(E_{SB} - E_c)$ and $m(\%)$.

4.2 Measuring AM Signal Modulation Frequencies and Modulation Indexes

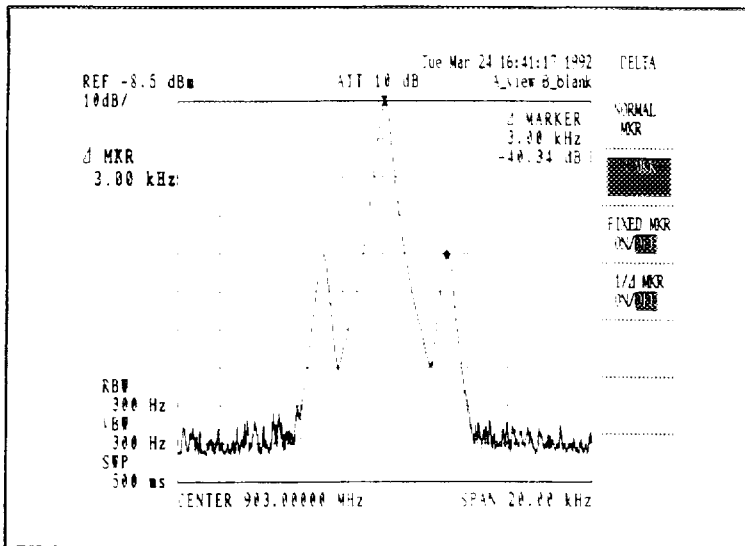

$f_m = 2.97 \text{ KHz}$
 $E_{SB} - E_C = 40.34 \text{ dB}$

Figure 4-7 AM Signal With a High Modulation Frequency and a Small Modulation Index

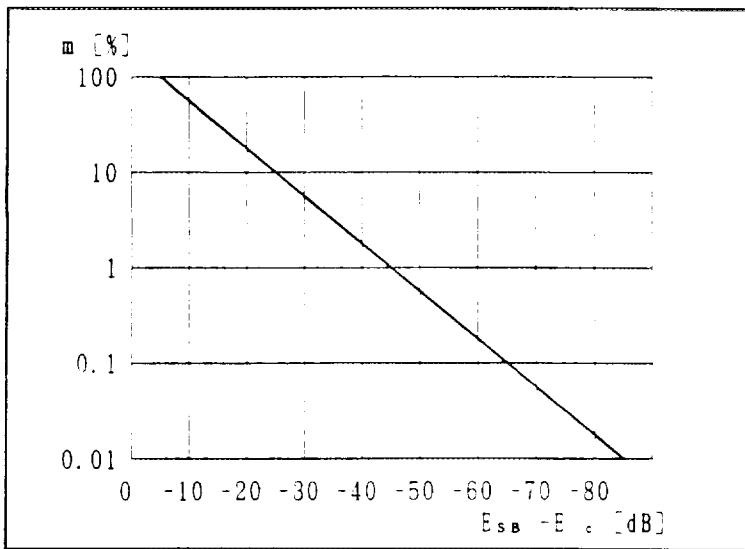

Figure 4-8 Side Band Level: Relationship Between the Carrier Level ($E_{SB} - E_C$) and the Modulation Index m (%)

4.3 Measuring FM Signals

Common FM wave measurements include the following:

- the carrier frequency f_c
- the modulated wave frequency f_m
- the frequency shift Δf_{peak}
- the modulation index m
- the occupied frequency bandwidth.

The FM modulation index m can be expressed as $\Delta f_{\text{peak}} / f_m$. The modulation index m or frequency shift Δf_{peak} can be obtained by varying the modulation index and determining where the carrier is at a minimum (see Figure 4-9 (a) and (b)). For example, the second sideband is the minimum in Figure 4-9 (a). This corresponds to the third peak in Figure 4-9 (b), which indicates an m value of 5.6 along the Figure's x-axis.

If the modulation frequency is too low to be analyzed sufficiently from the spectrum, the analyzer can display the amplitude change from the FM composite of the input signal using the IF bandpass filter slope. The modulated wave is then displayed on the screen. (See Figure 4-9 (c).)

If the modulation frequency is low, set the analyzer's horizontal axis to zero span mode so that it operates as a fixed tuning receiver in the time domain. You can then measure along the time axis.

If the modulation frequency is high, measure along the frequency axis and determine the modulation frequency from the frequency of the side band.

If the modulation index is small (0.8 or less), determine m from the relationship between the carrier level and the first side band level given in Figure 4-4(b).

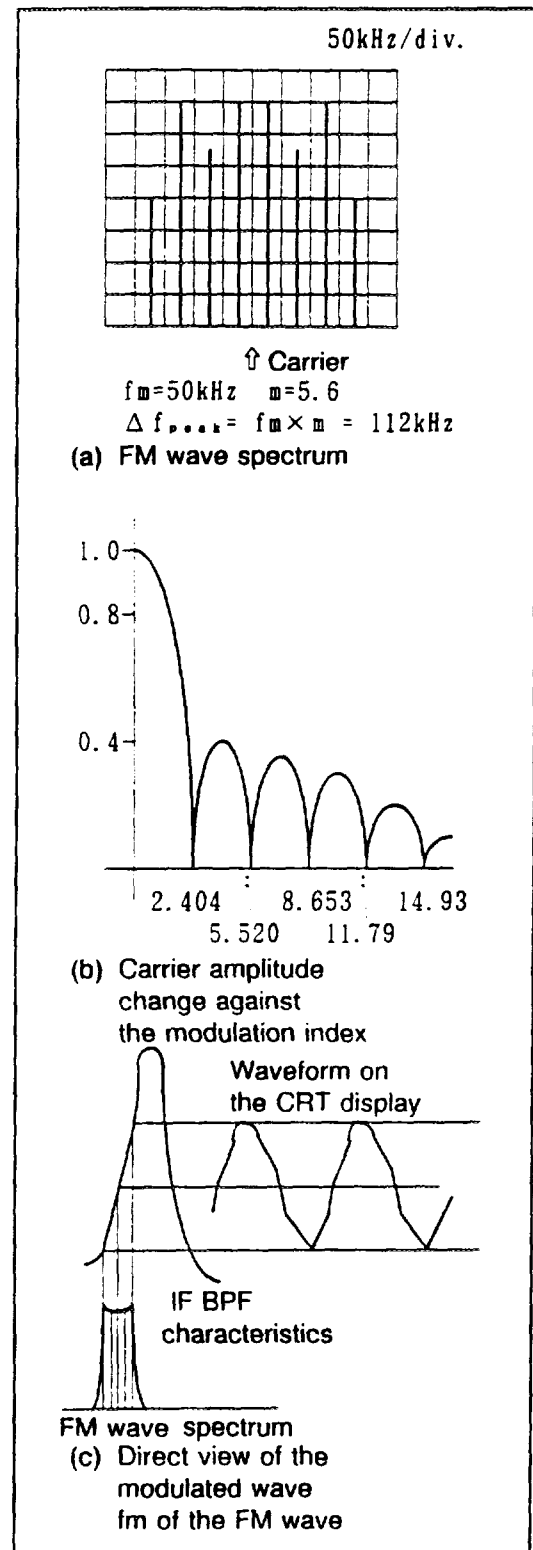

Figure 4-9 Measuring an FM Signal

4.3.1 Measuring FM Signals With Low Modulation Frequencies and High Modulation Indexes

Procedure

- ① Center the signal carrier.

Press **CENTER FREQ** and use the step keys or data knob to set the center frequency.

- ② Set the resolution bandwidth to at least three times the modulation frequency.

Press **CPL** **RBW** and use the step key to set the bandwidth.

- ③ Set the signal peak at the reference level.

Press **REF LEVEL** and use the data knob to set the signal's peak at the screen REF line.

- ④ Turn ZERO SPAN mode on.

Press **FREQ SPAN** **ZERO SPAN**.

- ⑤ Adjust the center frequency so that the demodulated signal is at the center of the screen.

Press **CENTER FREQ** and use the step keys or data knob to position the wave.

- ⑥ Set trigger mode to VIDEO.

Press **MENU** **TRIGGER** **VIDEO**.

- ⑦ Select a sweep time that allows you to view the demodulated signal easily.

Press **CPL** **SWP** and use the step keys to set the sweep time.

- ⑧ Set the marker at the demodulated wave peak.

Press **Peak**.

- ⑨ Set the delta marker on the adjacent peak.

Press ON Δ MKR and use the data knob to position the delta marker.

Set 1/ Δ MKR ON/OFF to ON to obtain the modulation frequency fm.

Note: $f_m = \frac{1}{T(s)}$

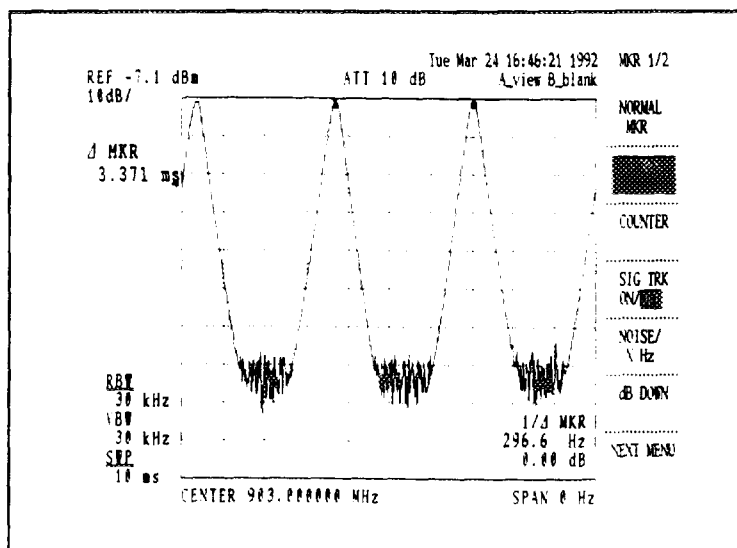

$f_m = 300.4 \text{ Hz}$

Figure 4-10 FM signal With Low Modulation Frequency

4.3.2 Measuring FM Signals With High Modulation Frequencies and Small Modulation Indexes

Procedure

- ① Set the frequency span to a range between two and ten times the modulation frequency.

Press **FREQ SPAN** and use the step keys to set the span.

- ② Set the carrier frequency to the center frequency.

Press **CENTER FREQ** and use the data knob to set the center frequency.

- ③ Set the marker at the carrier peak.

Press **Peak**

- ④ Set the delta marker at the peak of the adjacent side band.

Press **ON** **△ MKR** and use the data knob to position the delta marker.

The frequency indication of the delta marker is the modulation frequency fm.

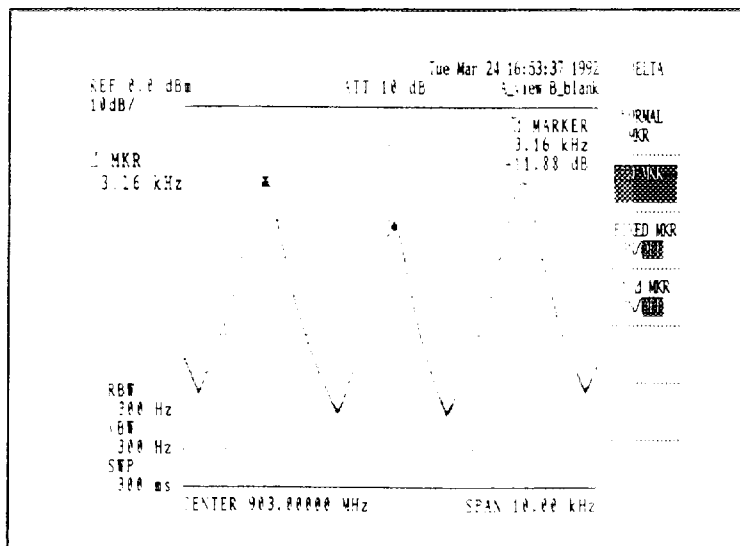

Figure 4-11 FM Signal With High Modulation Frequency and Small Modulation Index

4.3.3 Measuring FM Signal Peak Shifts (Δf_{peak})

Procedure

- ① Set the resolution bandwidth high enough to include the main side bands (at least five times greater than the modulation frequency).

Press **CPL** **RBW** and use the step key to adjust the resolution bandwidth.

- ② Center the carrier frequency.

Press **CENTER FREQ** and use the data knob to adjust the frequency.

- ③ Set the frequency span slightly larger than the peak shift so that measurements can be made easily.

Press **FREQ SPAN** and use the step keys to adjust the frequency span.

- ④ From the waveform, determine $\Delta f_{\text{peak to peak}}$ and m using the following formulas:

$$\Delta f_{\text{peak}} = \frac{1}{2} \Delta f_{\text{peak to peak}}$$

$$m = \frac{\Delta f_{\text{peak}}}{f_m}$$

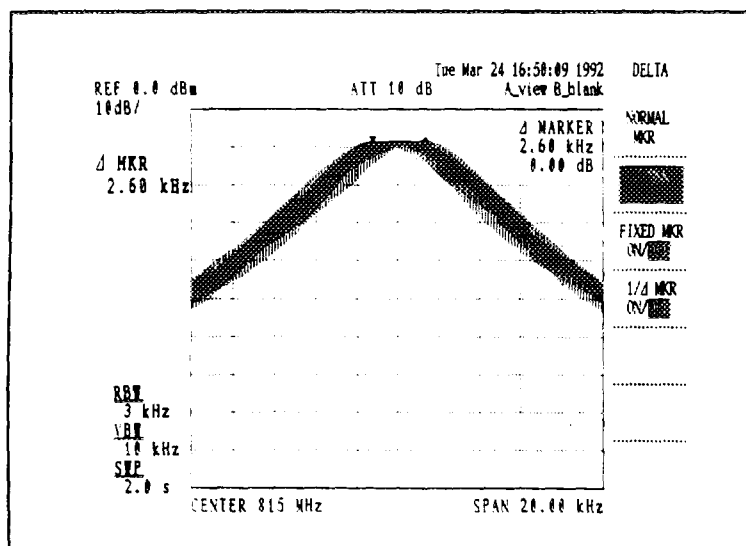

- When Δf_{peak} is small:
In this example, $\Delta f_{\text{peak to peak}}$
= (delta marker frequency)/2
= 2.26kHz

$$\Delta f_{\text{peak}} = \frac{1}{2} \Delta f_{\text{peak to peak}} = 1.13\text{kHz}$$

Figure 4-12 FM Signal With Small Δf_{peak}

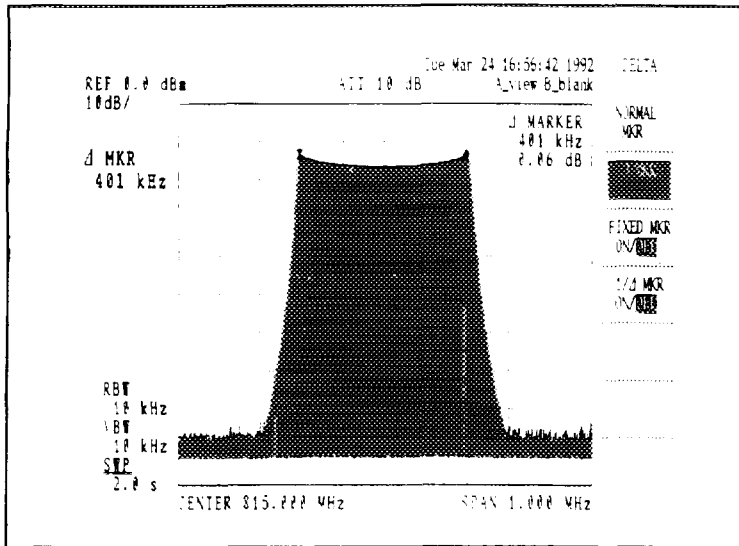
Figure 4-13 FM Signal With Large Δf_{peak}

- When f_{peak} is large:
In this example, $f_{\text{peak to peak}}$
= (delta marker frequency)/2
= 374kHz

$$\Delta f_{\text{peak}} = \frac{1}{2} \Delta f_{\text{peak to peak}} = 187\text{kHz}$$

4.3.4 Measuring Small FM Modulation Indexes

If the FM wave modulation index m is 0.8 or below, the following approximation holds:

$$m = \frac{2E_{\text{SB}}}{E_{\text{C}}}$$

E_{SB} : 1st side band level
 E_{C} : Carrier level

Procedure

- Set the center frequency and the frequency span so that the carrier can be viewed easily, and set the carrier level to the reference level.

Press **CENTER FREQ** and use the data knob to adjust the center frequency.

Press **FREQ SPAN** and use the step keys to adjust the span.

Press **REF LEVEL** and use data knob to set the carrier to the reference level.

- Write down the carrier frequency f_{C} (from the center frequency indicator) and the carrier level E_{C} (from the reference level indicator). (See Figure 4-14.)

- Move the delta marker to the first side band and write down the frequency f_{SB} and level E_{SB} (from the delta marker indicator).

Press **Peak** **ON** **Δ MKR** and use the data knob to position the delta marker on the first side band. (See Figure 4-15.)

- ④ Calculate the FM modulation index m using the following formula:

$$m = 2 \times \frac{E_{SB}}{E_C} = \log^{-1} \frac{E_{SB} - E_C + 6}{20}$$

- ⑤ Calculate the modulation frequency f_m using the following formula or from the delta marker frequency indicator:

$$f_m = 1f_{SB} - f_{C1}$$

- ⑥ Calculate the frequency shift f_{peak} using the following formula:

$$\Delta f_{peak} = m \times f_m$$

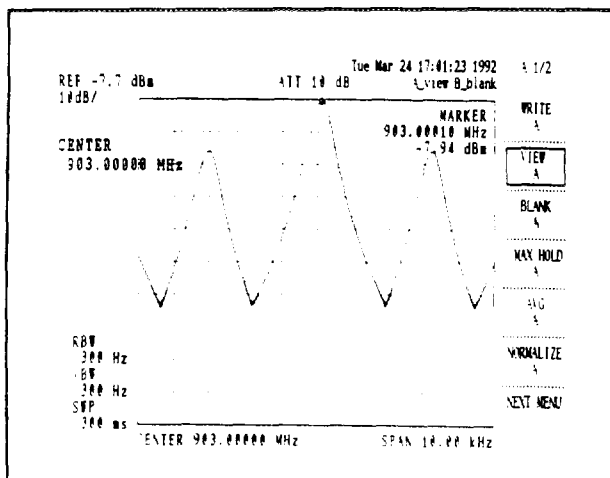

Figure 4-14 FM Signal f_c and E_c

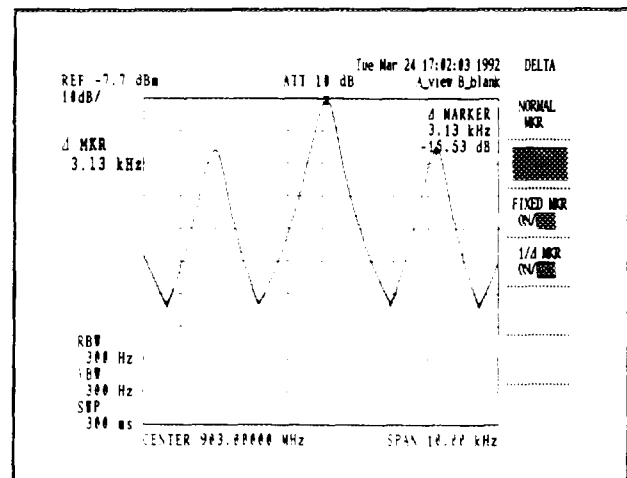

Figure 4-15 FM Signal f_{SB} and E_{SB}

4.4 Measuring Pulse-modulated Signals

The spectrum analyzer can analyze pulse-modulated waveforms and display the higher harmonics and dominant wave contained in the waveform. As shown in Figure 4-16 (a) and (b), converting the time-axis view of a pulse-modulated wave into the frequency-axis view gives a spectrum distribution having an envelope centered at the carrier f_c .

The following measurements are commonly made for pulse-modulated radar waves:

- Pulse width (τ)
- Carrier frequency (f_c)
- Peak power (P_{peak})
- Average power (P_{ave})
- Pulse repetition frequency (PRF)

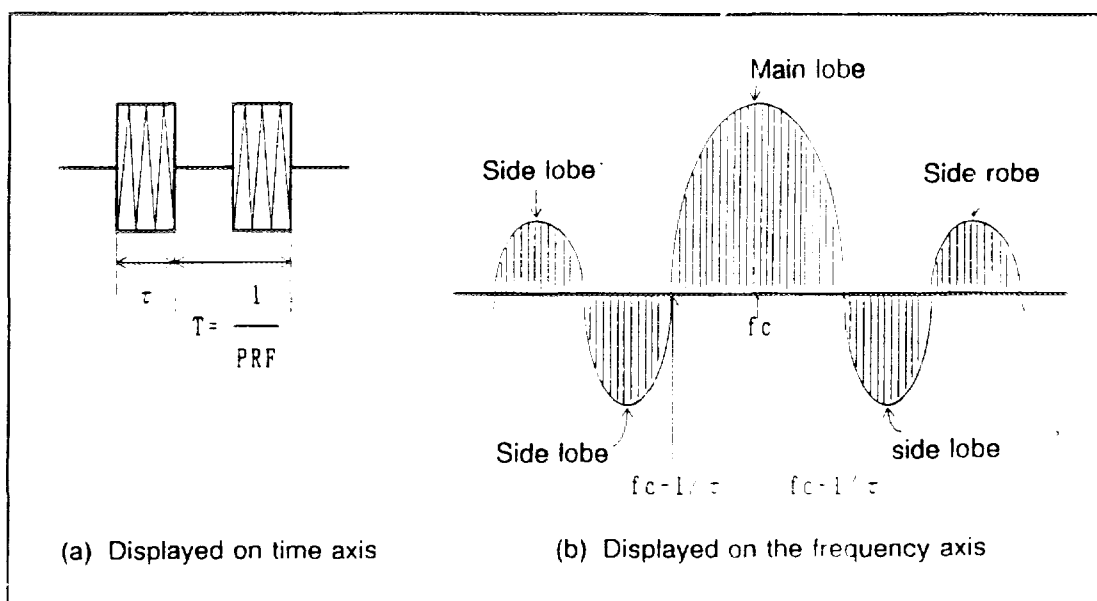

Figure 4-16 Pulse-modulated Signal

CAUTION

1. The analyzer's maximum allowable input level is +30 dBm and 0 VDC when the input attenuator is set to 10 dB or above. Use a coupler to attenuate pulse-modulated radar waves that have large peaks before feeding them into the analyzer's input connector.
2. Since the analyzer's mixer input level is -10 dBm, set the input attenuator so that $P_{\text{peak}} \leq -10$ dBm. To prevent mixer saturation, lower the input attenuator by 10 dB intervals starting at 50 dB, and find the minimum attenuator value that does not lower the signal level.

(1) Pulse width (τ)

The pulse width τ is equal to 2 divided by the width of the main lobe, or the inverse of the width of a side lobe (see Figure 4-16). Set the resolution bandwidth in the range described below.

$$\text{Pulse repetition frequency (PRF)} \times 1.7 \leq \text{Resolution bandwidth} \leq 0.1/\tau$$

(2) Carrier frequency (F_c)

The pulse width τ determines how accurately the carrier frequency (f_c) can be measured. If τ is small, the main lobe of the signal spreads out and determining the center becomes difficult. To display the center accurately, set SPAN/DIV wider than $1/\tau$. This gives an accuracy equal to the center frequency accuracy at the SPAN/DIV specified.

(3) Peak power (P_{peak})

The indicated amplitude is proportional to the resolution bandwidth if the resolution bandwidth of the spectrum analyzer satisfies the following condition:

$$\text{Pulse repetition frequency (PRF)} \times 1.7 \leq \text{Resolution bandwidth} \leq 0.2/\tau$$

Under this condition, the relationship between the actual peak power P_{peak} (dBm) and the indicated amplitude P'_{peak} (dBm) can be expressed as follows:

$$P_{\text{peak}} = P'_{\text{peak}} - \alpha \text{ (dB)} \quad \alpha: \text{ Pulse attenuation factor}$$

$$\alpha \text{ (dB)} = 20 \log (\tau \times 1.5 \times \text{RBW})$$

(4) Average power (P_{ave})

The average power P_{ave} (in dBm) is determined as follows.

$$P_{\text{ave}} = P_{\text{peak}} \times \text{PRF} \times \tau$$

PRF: Pulse repetition frequency (Hz)
 τ : Pulse width(s)

4.5 Measuring Occupied Bandwidths (OBW)

The analyzer's OBW feature lets you calculate the occupied bandwidth of trace A for testing communications equipment. You enter a percentage, and the analyzer marks the frequency range that percentage of the signal lies in. The percentage is the ratio of the occupied bandwidth to the entire power spectrum, and can be set from 10.0% to 99.8%. The initial value is 99%.

NOTE

1. To reduce calculation errors, adjust the reference level and span so that the signal's amplitude is above 50 dB and the span is about three times the occupied bandwidth.
2. To minimize measurement errors, set the analyzer's resolution bandwidth to below 3% of the occupied bandwidth.
3. If the signal is noisy (especially if the modulated wave is a false aural signal), set the trace detection mode to SAMPLE to minimize errors.

(1) Measure the OBW as follows. (This example uses a center frequency of 902 MHz, a frequency span of 50 kHz, and an RBW of 300 Hz.)

- ① Center the trace A signal. Set the frequency span to three times the occupied bandwidth and set the resolution bandwidth to below 3% of the occupied bandwidth.

Press A WRITE A .

Press CENTER FREQ 9 0 2 MHz .

Press FREQ SPAN 5 0 kHz .

Press CPL [Data Setting].

Press RBW 3 0 0 Hz .

- ② Set the Trace detection mode to SAMPLE.

Press MENU TRACE DET SAMPLE .

- ③ Measure the occupied bandwidth.

Press SHIFT 3 UTIL OBW .

When the calculation is complete, the occupied bandwidth and the carrier frequency (Fc) appear at the upper right of the screen, and markers are set at the ends of the occupied bandwidth.

For example, if the ratio is 99.0%, the markers are set at 0.5% and 99.5% of the entire displayed power spectrum.

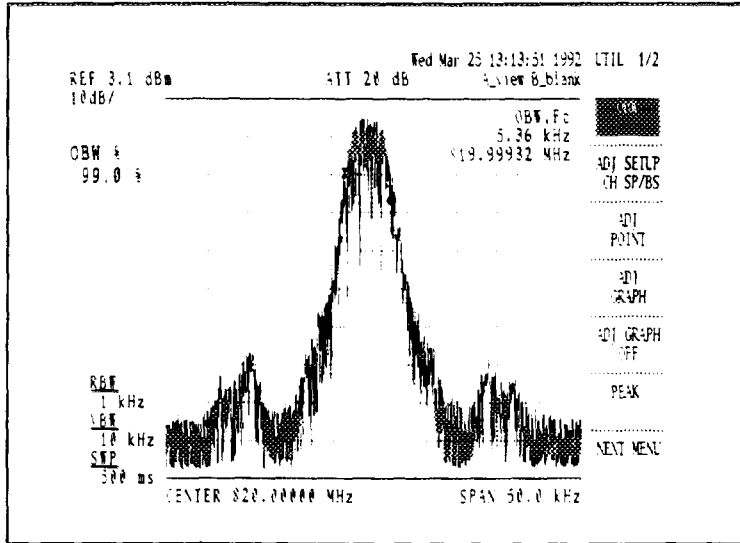

Figure 4-17 Measuring the OBW

- ④ If needed, change the OBW-to-power-spectrum ratio using the numeric keypad. For example, you would change this ratio to 80% as follows:

Press **SHIFT** **3** **OBW** to display the occupied bandwidth.

Press **8** **0** **GHz** to set the ratio to 80%.

(2) How the Analyzer Calculates the Occupied Bandwidth

The data on the analyzer screen consists of 701 points plotted along the frequency axis. If the voltage of a point n is V_n , then the total power P of the portion of the signal represented by all points is:

$$P [W] = \sum_{n=1}^{701} \frac{V_n^2}{R} \quad (R: \text{Input impedance})$$

The following expression is satisfied if the sum of the powers over the interval from the screen left end to the X th point is 0.5% of the total power P :

$$0.005P = \sum_{n=1}^X \frac{V_n^2}{R} \quad (\text{When the ratio is 99.0\%})$$

The following expression is satisfied if the sum of the powers over the interval from the screen left end to the Y th point is 99.5% of the total power P :

$$0.995P = \sum_{n=1}^Y \frac{V_n^2}{R} \quad (\text{When the ratio is 99.0\%})$$

Since the occupied bandwidth is the portion of the band from .005 P to .995 P , the analyzer finds the occupied bandwidth by solving the above two equations for X and Y , and substituting these values in the following expression:

$$\text{OBW [Hz]} = \frac{f_{\text{SPAN}}(Y-X)}{701} \quad (f_{\text{SPAN}}: \text{Frequency span})$$

4.6 Measuring Adjacent Channel Leak Power (ADJ)

The analyzer's adjacent channel leak power feature lets you calculate how much a signal in one communications channel leaks into adjacent channels. To measure the adjacent channel leak power, the analyzer determines the total power over a specified bandwidth and calculates the ratio of the power in each channel to the total signal power.

The analyzer provides two types of leak power measurements:

ADJ POINT

and

ADJ GRAPH

- ADJ POINT : Measures the leak power of the upper and lower channels. (You specify the channel spacing.)
- ADJ GRAPH : Measures the leak power of all channels in the bandwidth specified and displays the result as a graph.

NOTE

1. The analyzer's dynamic range is lowered if the signal level is much lower than the reference level.
Use a span four or five times the channel spacing of the radio.
2. To minimize measurement error, set the analyzer's bandwidth to less than 1/40th of the specified bandwidth.
3. If the signal is noisy (especially if the modulated wave is a false aural signal), set the Trace detection mode to SAMPLE to minimize the error.

- (1) Measure the leak power as follows. (This example uses a center frequency of 902 MHz, a frequency span of 50 kHz, and an RBW of 100 Hz.)

- ① Center the trace A signal and specify the frequency span and resolution bandwidth values .

Press A WRITE A .

Press CENTER FREQ 9 0 2 MHz .

Press FREQ SPAN 5 0 kHz .

Press CPL RBW 1 0 0 Hz .

Press REF LEVEL and use the knob to move the signal into the vicinity of REF.

- ② Set the Trace detection mode to SAMPLE.

Press MENU TRACE DET SAMPLE .

- ③ To use ADJ POINT follow paragraph (a). To use ADJ GRAPH follow paragraph (b).

(a) Using ADJ POINT

- (a-1) Set the marker to the frequency of the specified channel.

Press MARKER ON 9 0 2 MHz .

- (a-2) Select the adjacent channel leak power mode and set the specified bandwidth and channel spacing.

Press SHIFT UTIL 3 ADJ SETUP CH SP/BS to select CH SP.

Press 1 2 . 5 kHz .

Press ADJ SETUP CH SP/BS to select BS, and press 8 . 5 kHz .

(a-3) Measure the adjacent channel leak power.

Press



The marker indicates the point of the specified channel frequency \pm channel spacing. The power ratio of the upper adjacent channel against the lower adjacent channel is displayed in the upper right corner of the screen.

This calculation repeats every time



is pressed.

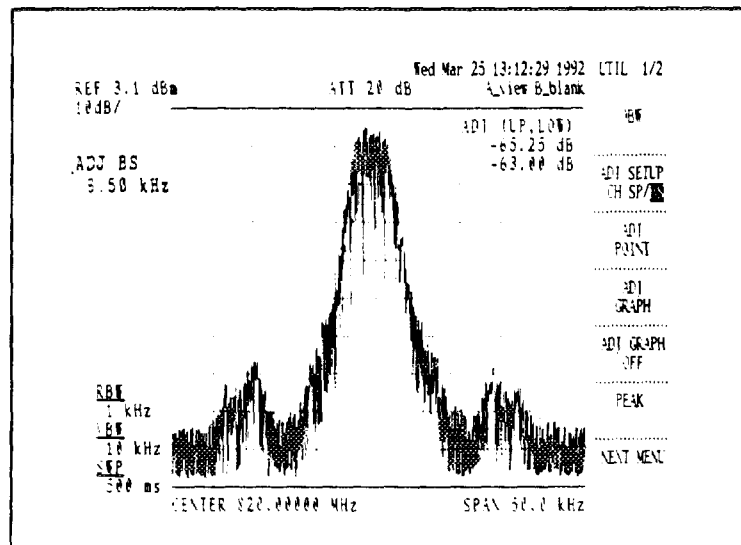



Figure 4-18 Measuring the Adjacent Channel Leak Power (ADJ POINT)



NOTE

1. Before using ADJ POINT, set the marker to the frequency of the specified channel as described in step (a-2). This function will not operate if the channel spacing and the specified bandwidth are not set or are set incorrectly.
2. After measurement, the marker function automatically enters delta marker mode. Before taking a measurement, remember to set the marker to the specified channel frequency.

(b) Using 

(b-1) Select adjacent channel leak power mode and set to specified bandwidth (BS).

Press    to select BS.

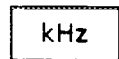



Press     to set the specified bandwidth.

(b-2) Measure the adjacent channel leak power.



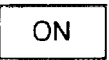

Press 

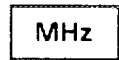
The result is displayed on screen B. The result is displayed every time the key is pressed.

(b-3) Use the delta marker to measure the adjacent channel leak power with the channel spacing displayed.

Press      and set the marker to the specified channel frequency.

Press  and use the data knob, step keys, and numeric keypad to set the adjacent channel frequency.

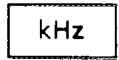
Press     

The adjacent channel leak power ratio is displayed in the upper right corner of the screen.

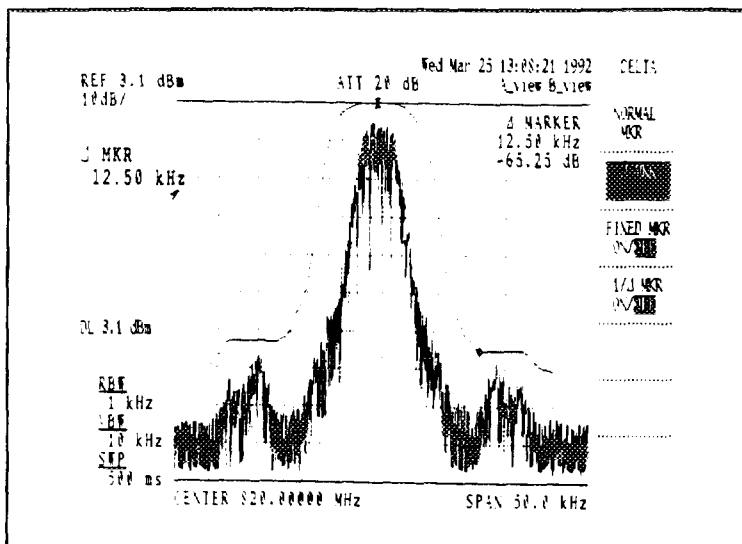

Figure 4-19 Measuring the Adjacent Channel Leak Power (ADJ GRAPH)

NOTE

This function will not operate if the bandwidth is not set or is set incorrectly.

(2) How the Analyzer Calculates the Adjacent Channel Leak Power

The data on the analyzer screen consists of 701 points plotted along the frequency axis. If the power of point n is P_n , then the total power P of the portion of the signal represented by all points is:

$$P [W] = \sum_{n=1}^{701} P_n$$

If ΔX is assumed to be the specified bandwidth (BS), the adjacent channel leak power at the n th point from the left end of the screen is determined by:

$$P_{ADJ} [db] = 10 \log_{10} \frac{\sum_{n = \frac{\Delta x}{2}}^{n + \frac{\Delta x}{2}} P_n}{P}$$

$$\left(n - \frac{\Delta x}{2} \geq \text{Start frequency and } n + \frac{\Delta x}{2} \leq \text{Stop frequency}\right)$$

4.7 Analyzing Burst Signal Spectra

You can analyze burst signal spectra using the analyzer's gated sweep function. Burst signal measurements are often necessary when working with magnetic tape equipment such as VTR, 8mm video, and digital audio tape (DAT) equipment.

To analyze a burst signal spectrum, use the gated sweep control terminal (the GATE IN terminal on the analyzer's rear panel) for gate control. The sweep starts at the TTL level "High" (or Open) and stops at "Low".

Set the input signal and the gate control signal as specified below.

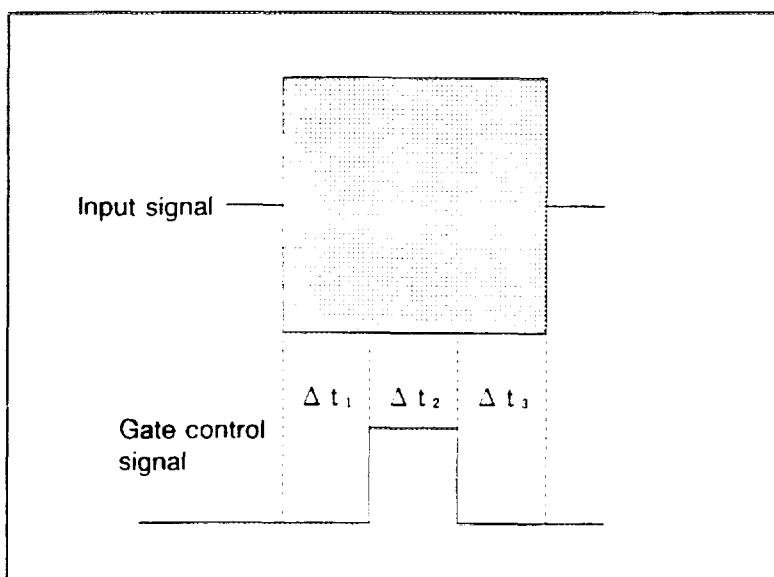

	RBW				
	3 MHz, 1 MHz	300 kHz	100 kHz	30 kHz	10 kHz
Δt_1	2 μ s or more	15 μ s or more	20 μ s or more	50 μ s or more	180 μ s or more
Δt_2	1 μ s or more				
Δt_3	1 μ s or more				

Note: When measuring noise, set the detection mode to SAMPLE.

4.8 Measuring with Tracking Generator (R3365A/3371A only)

The operation for amplitude-frequency characteristic measurement and amplitude linearity measurement, using a tracking generator, is explained as follows with actual measurement examples.

4.8.1 Examples of Amplitude-frequency Characteristic Measurement

(1) The Operating Procedure

- ① Turn the tracking generator ON, and enter the output level.

Press **TG** **MAG** **OUTPUT LEVEL** and use the numeric keypad, step keys

or data knob to set the output level. (enable by 0.1 dB step)

- ② Enter the center frequency, frequency span and reference level.

Press **CENTER FREQ** and enter the center frequency with the numeric keypad, step keys or data knob.

Press **FREQ SPAN** and enter the center frequency with the numeric keypad, step keys or data knob.

Press **REF LEVEL** and enter the reference level with the numeric keypad, step keys or data knob.

NOTE

In resolution bandwidth $\leq 100\text{KHz}$, the tracking generator should be operated after pressing the **FREQ CAL** to compensate tracking error(level error caused by differences between the output frequency of the tracking generator and tuning frequency of spectrum analyzer).

- ③ Set up the test cables and feedthrough adapter as shown below in Figure 4-20.
The through frequency characteristics are displayed on the screen.

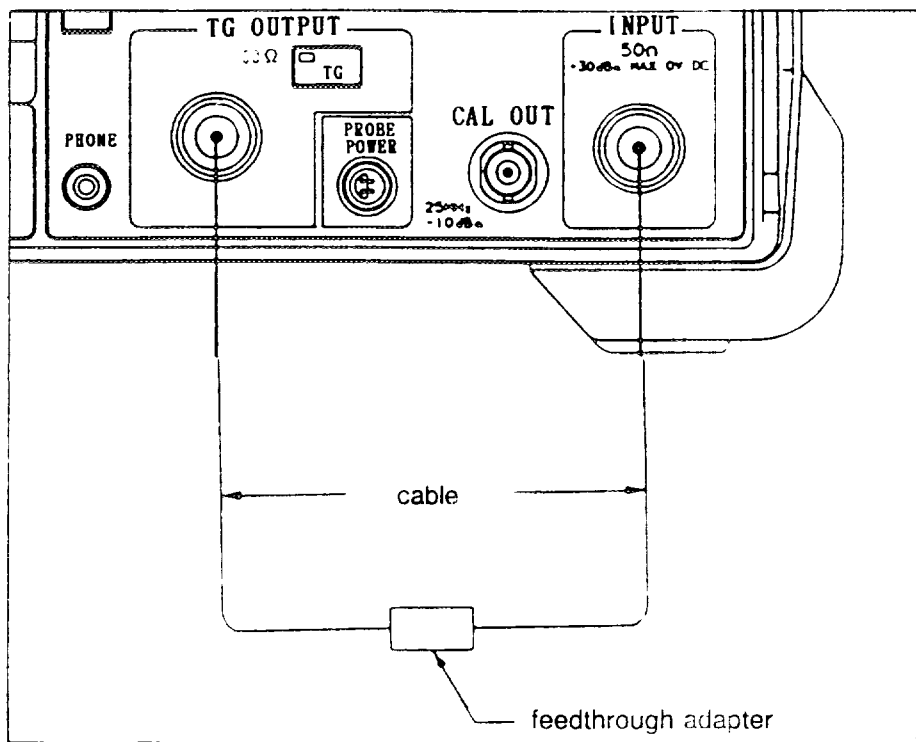

Figure 4-20 Connecting with Through State

- ④ If an error caused by the frequency response of cables spectrum analyzer etc. is not negligible, then you should compensate it as is described in step (2) later on.
- ⑤ Set up the DUT and test cable as shown in Figure 4-21.

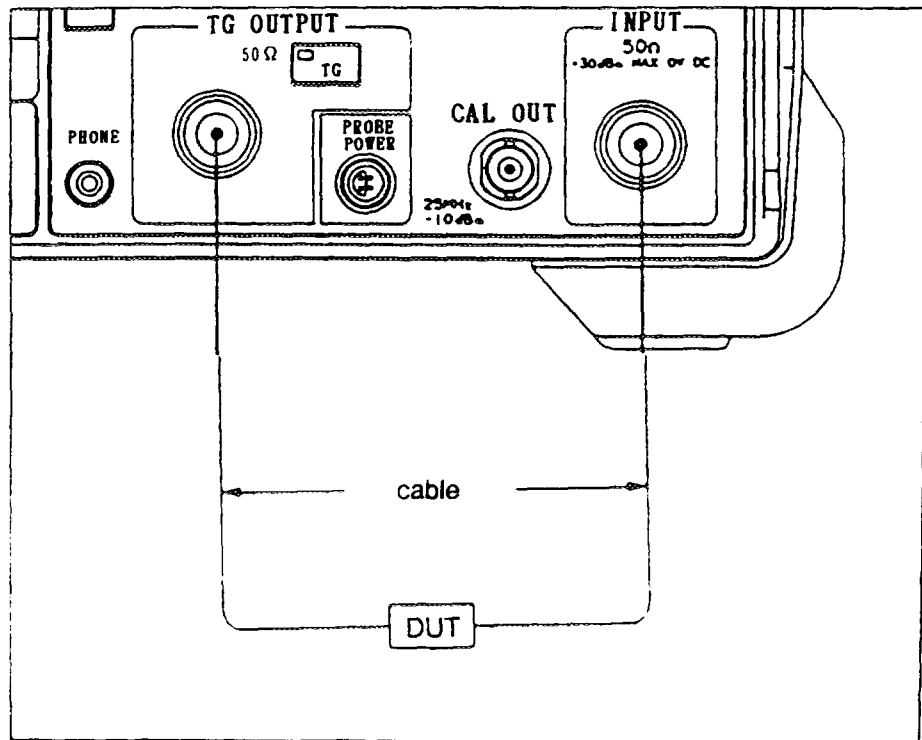

Figure 4-21 Connecting with DUT

CAUTION

When the Input and output impedances of the DUT are other than 50Ω, make sure to match the impedance of the DUT.

- (2) How to compensate the frequency characteristic based on display line.

This procedure shows how to compensate the frequency characteristics of the analyzer and the frequency characteristics of the measurement cables.

CAUTION

1. IF you change the function data (center frequency, frequency span, and reference level etc.), which has edited the normalization reference then the normalization may not operate correctly.

In this case, execute the normalization from the start.

2. This operation does not compensate the electric wave length of cable phase-delay etc.

- ① Select the trace A mode (or B mode).

Press A (or B).

- ② Set up the test cables and feedthrough adapter as shown below (Figure 4-22)

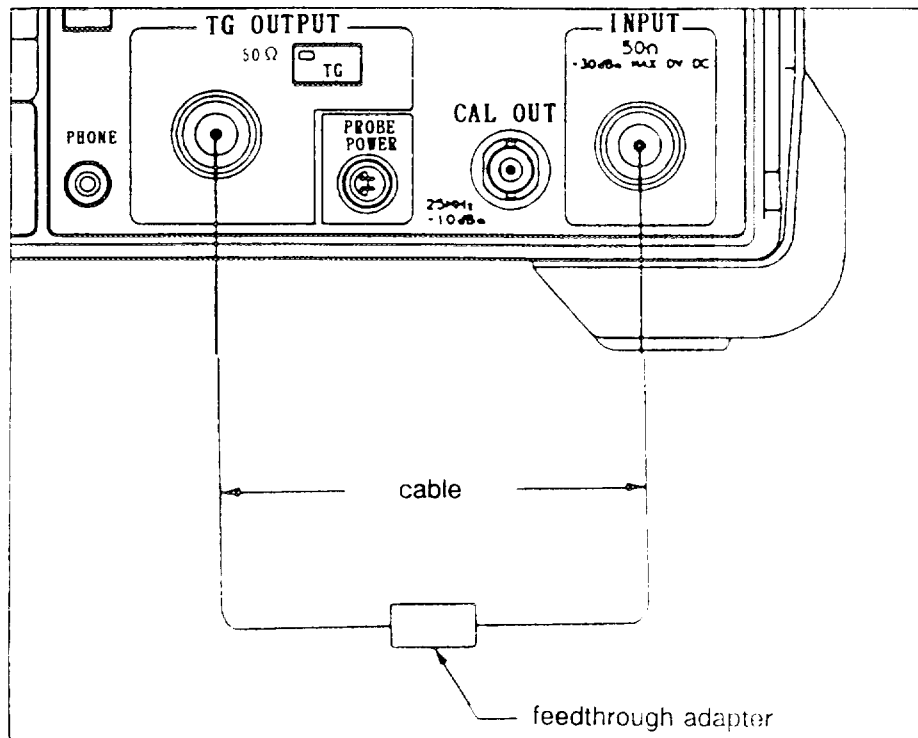

Figure 4-22 Connecting with Through State

- ③ Make sure of the position of the trace on the display, and adjust that position to the suitable grid area as is shown below in Figure 4-23.

Press the **REF LEVEL** and use the step keys or data knob to adjust the values.

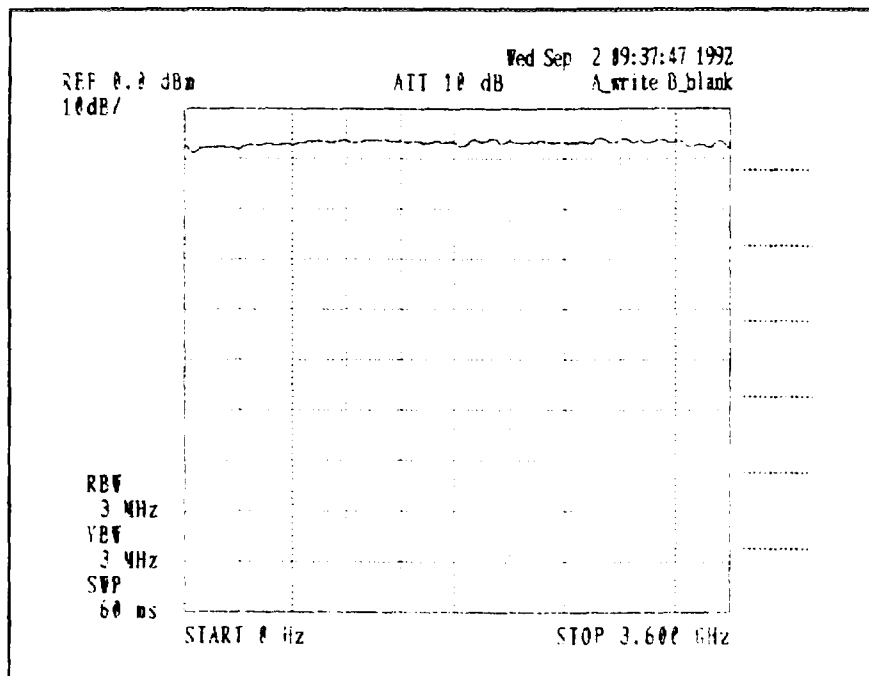

Figure 4-23 Trace of the feedthrough characteristic

- ④ Display the display-line on the screen and move it near the trace .

The analyzer can operate on a wide dynamic range when the display line is close to trace.

Press A NORMALIZE A DSP LINE ON / OFF

(or B NORMALIZE A DSP LINE ON / OFF)

and use the step keys or data knob to adjust the display line.

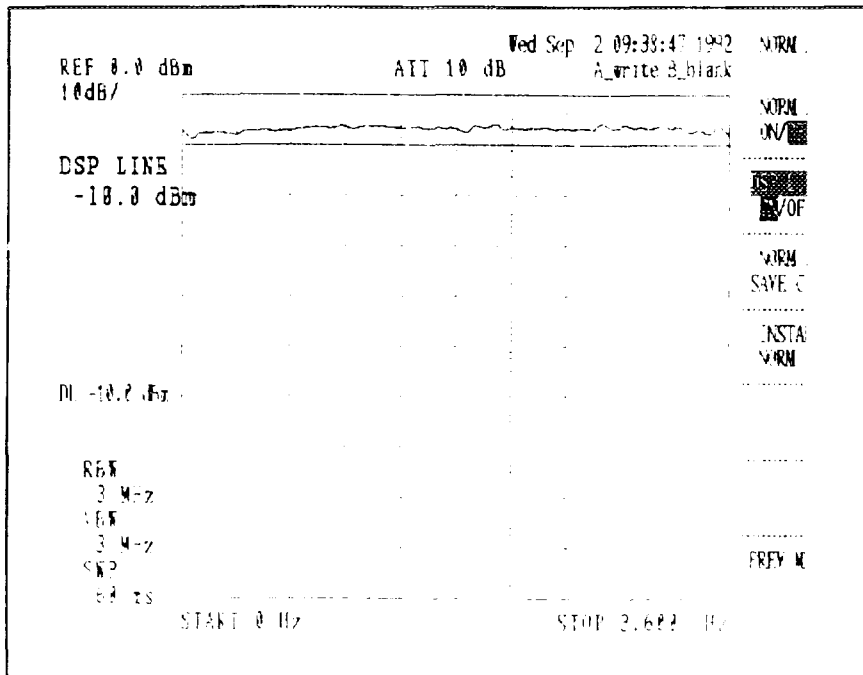
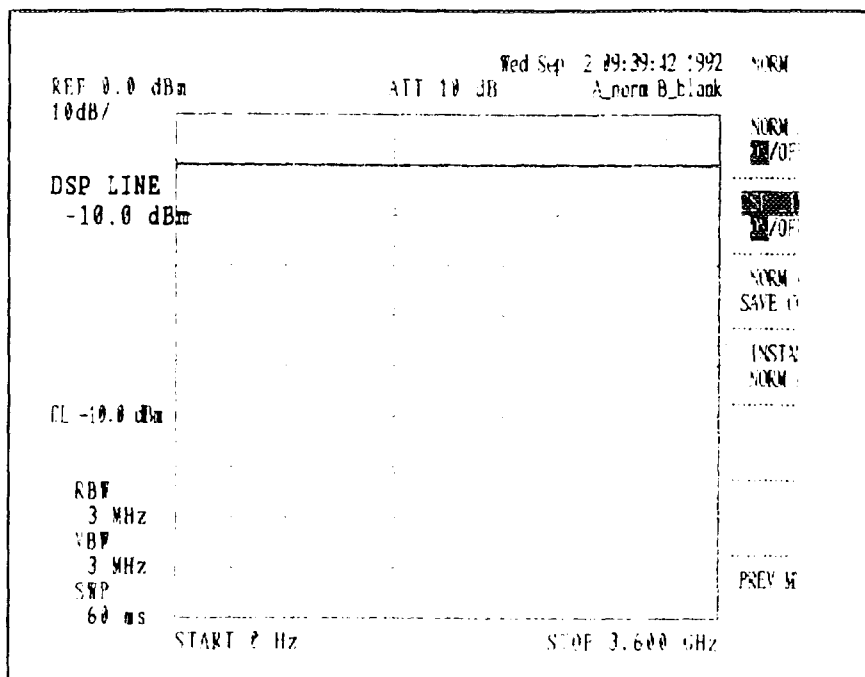

Figure 4-24 Display the Display-line and the Trace

- ⑤ Compensate the frequency characteristics.

Press NORM A
SAVE CORR NORM A
ON / OFF



- ⑥ Press NORM A
ON / OFF to cancel the compensation mode.

- (3) How to compensate the frequency characteristics using the "Through correction" function.

This function compensates the frequency characteristics using tracking generator on 38 point in frequency range of 3.6 GHz. The compensation is available, if you edit the data such as center frequency, frequency span and reference level.

NOTE

1. This compensation is not preferable to compensate the rough frequency characteristics. Therefore, compensate the frequency characteristics based on the display line.
2. This compensation does not compensate the electric wavelength of cable phase-delay etc.

① Press **TG** THROUGH
CORRECT

② Set up the test cables and feedthrough adapter as shown in the figure below.

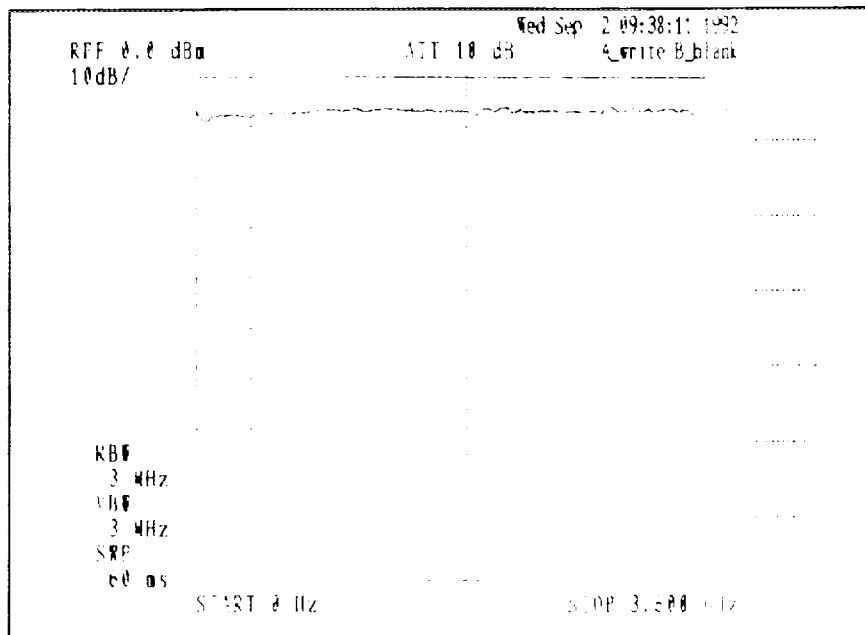
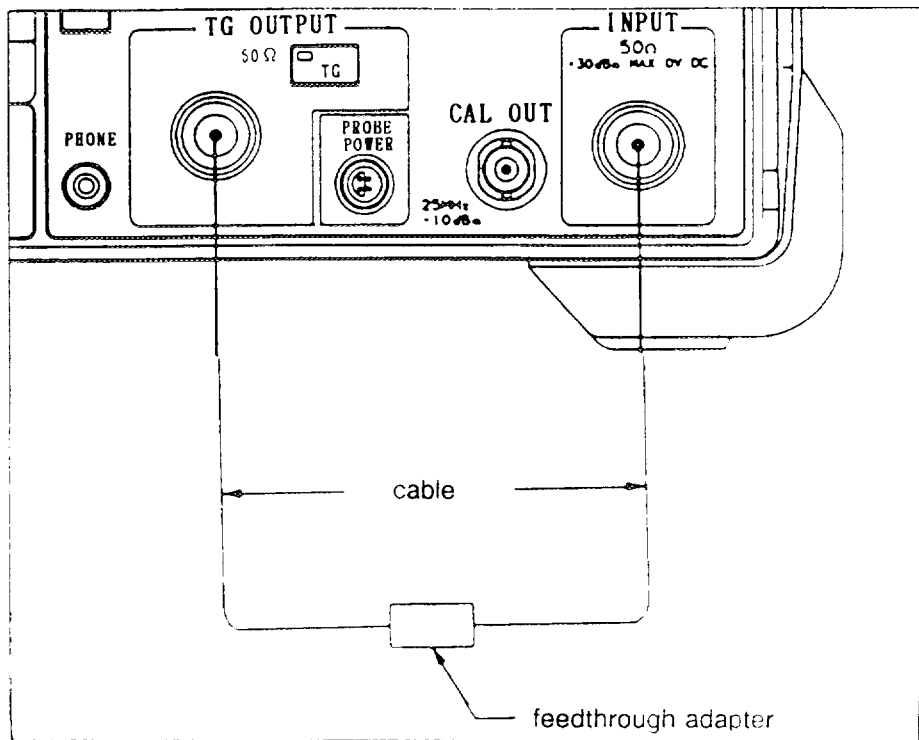

- ③ Press **THRU CORR EXECUTE** to compensate the frequency characteristics.

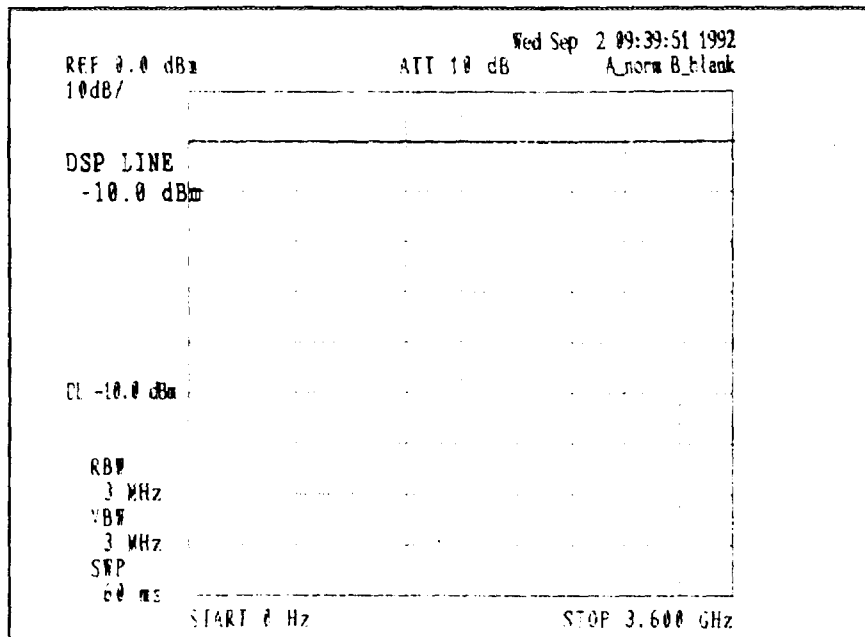

- ④ Press **THRU CORR** to cancel the compensation mode.

ON / OFF

4.8.2 Examples of Amplitude-Linearity Characteristics Measurement

(1) The Operating Procedure

- ① Turn the tracking generator ON to enter specify the output-level and sweep-time.

Press **TG** **POWER SWEEP** **START LEVEL** and use the numeric keypad, step keys or data knob to set the output level. (enable by 0.1 dB step)

- ② Set the stop level in the same way.

Press **STOP LEVEL** and use the numeric keypad, step keys or data knob to set the stop level.

- ③ Set up the test cables and feedthrough adapter as shown in the figure below. The display will show the through linearity (without DUT).

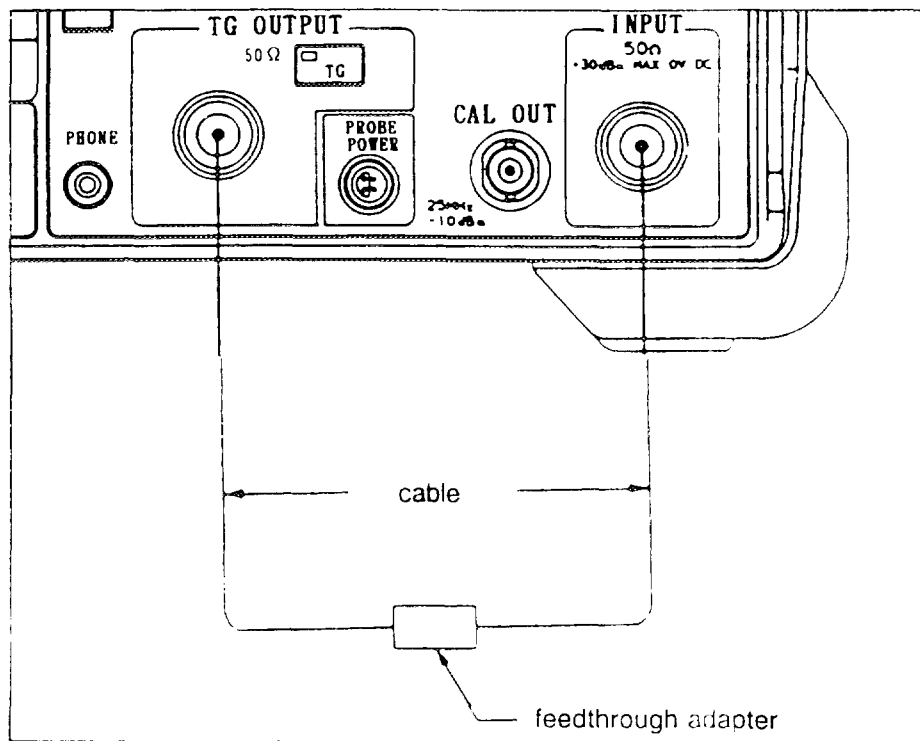

- ④ If an error caused by the output level linearity is not negligible, you should compensate it as described in step (3) (later on).

- ⑤ Remove the relay connector and connect a compensation device (DUT) as shown below. Start the measurement.

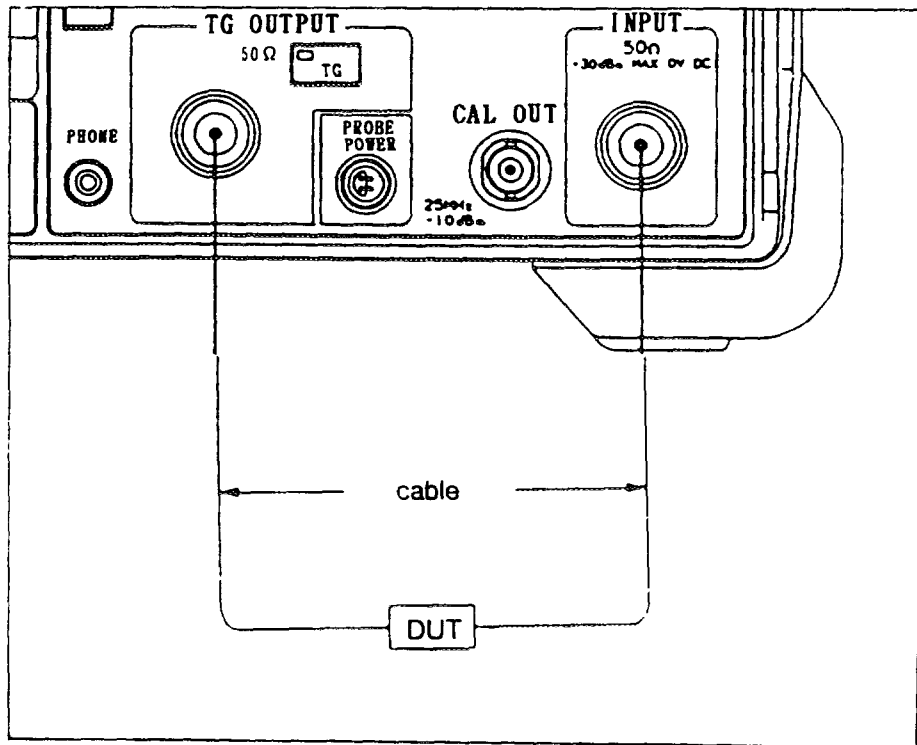

- (2) How to use the gain-compression display-function and reference line

The gain-compression display-function which is an exclusive function for power sweep mode is explained as follows.

- ① Press **TG** **POWER SWEEP** **REF.LINE** **REF.LINE ON/OFF** and turn the reference line ON.

- ② Press **XY dB** and use the numeric keypad, step keys or data knob to set the slope of the reference line.

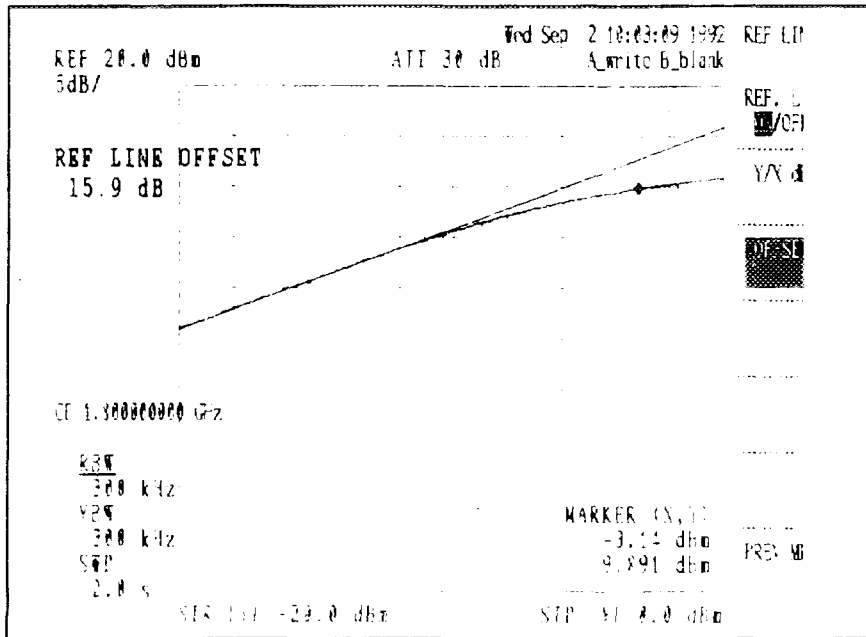

- ③ Press **OFFSET** and use the numeric keypad, step keys or data knob to set the offset value of the reference line (enable by 0.1 dB step).

- ④ Press **TG** **POWER SWEEP** **PxdB MKR** and use the numeric keypad, step keys or data knob to set the compression level (enable by 0.1 dB step). The gain-compression is displayed on the screen.

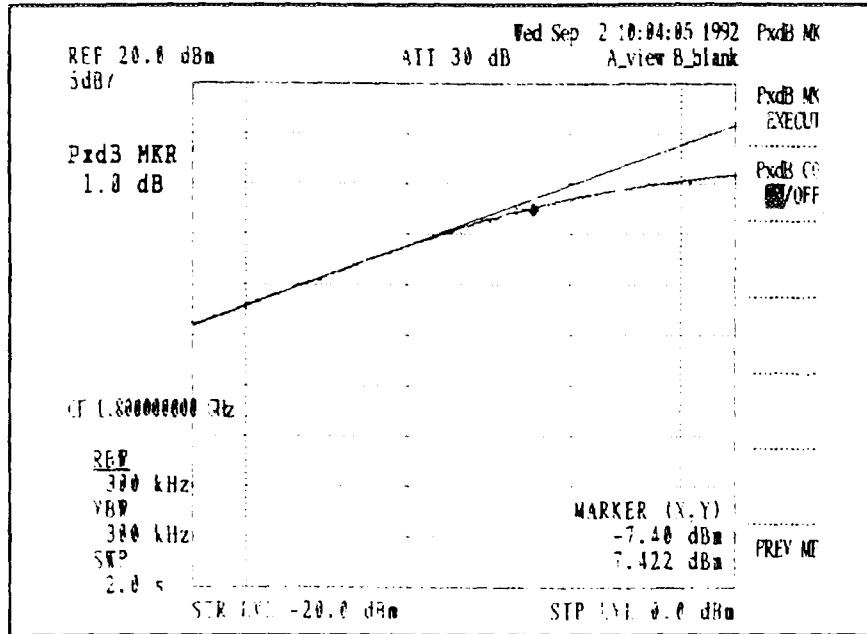

(3) How to compensate the linearity characteristics

The procedure on how to compensate the linearity of the spectrum analyzer using the power linearity calibration function is described as follows.

NOTE

If you change the function data (center frequency and reference level etc.), the calibration may not operate correctly. In this case, execute the calibration again from the start.

- ① Set up the test cables and feedthrough adapter.

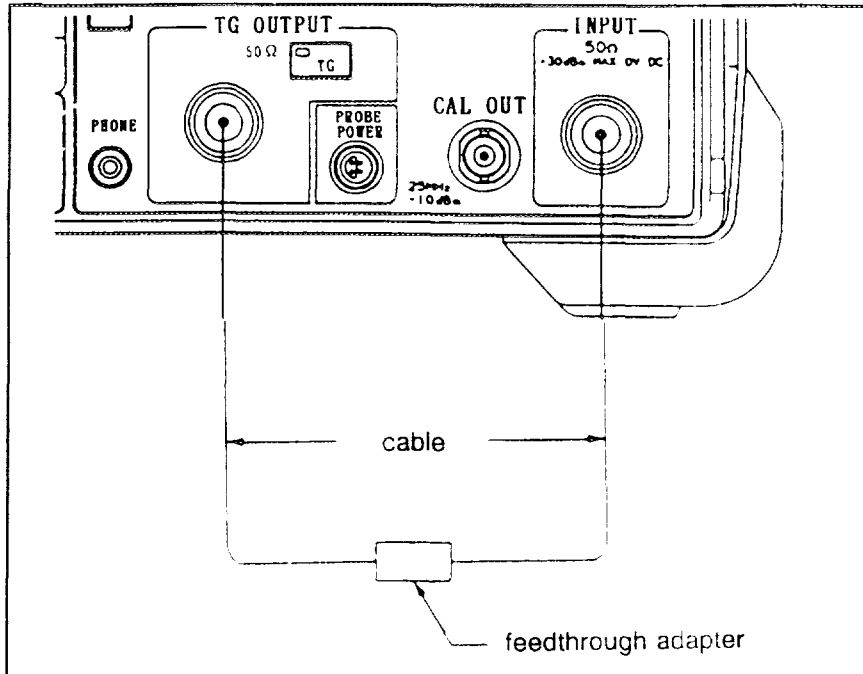

- ② Press TG CAL PWR LIN
CAL

4.8.3 Caution on Operations of Tracking Generator

(1) Dynamic Range

- ① The dynamic range to be measured is restricted by the maximum output level of the TG section and the noise floor of the receiver section. As the 'RBW absolute range width' and the 'noise floor of the receiver section' are decreased, so the dynamic range will increase.
However if the RBW is raised to its maximum and the local signal transmission of the TG section to the receiver section is leaking, then sometimes the noise level will not fall and the dynamic range will not be extended.
- ② If the transmission loss of DUT (including loss by the mismatching circuit) is large, the measurement dynamic range will be decreased in proportion to further loss. This problem can be solved by inputting to or outputting from the DUT with an amplifier.
- ③ The position of the amplifier (input or output) is selected according to the DUT conditions. The characteristics of the amplifier (gain, flatness, noise exponent, output level at 1 dB pressure point, input/output VSWR) should be known in advance.
- ④ Make sure the output level of the tracking generator is not too much. If so decrease it.

(2) Time Response

- ① On CRT display, the **UNCAL** message which indicates whether the level is correct or not is displayed. When measuring frequency characteristics with this device, this **UNCAL** display is ignored.
This message shows whether IF filter correctly indicates the level for sufficient response to time by the combination of settings for **FREQ SPAN**, **SWP** and **RBW**.
- ② When the signal level which is provided from the measuring device output edge to the main body of the spectrum analyzer changes a bit the display is correct in some cases regardless of the **UNCAL** message.
- ③ When the signal level which is provided from the measuring device output edge to the main body of spectrum analyzer changes a lot suddenly, care is taken for the time response of the measured device since this IF filter can not be received.
- ④ In this time response, when the characteristics displayed on the screen not changed by the switch of SWP, this IF filter and the measured device are sufficiently responding. If it is changed by the switch of SWP, SWP should be delayed and the Span (frequency sweep width) should be decreased until the characteristics on the screen donot change.

(3) Prevention of over voltage applying to TG OUTPUT connector

The voltage of $\pm 10V$ or more and electric power of +15dBm or more should not be applied.
(The TG may be damaged.)

5. KEY FUNCTIONS

This chapter explains how to use each of the analyzer's keys. As you read this chapter, try using the various functions described (use the 25 MHz calibration signal on the front panel as a convenient signal source). Appendix 3 lists the analyzer's menus and shows how to access them.



5.1 Basic Key Functions

The basic key section on the front panel contains the center frequency, frequency span, start and stop frequency, coupling, reference, and menu keys.

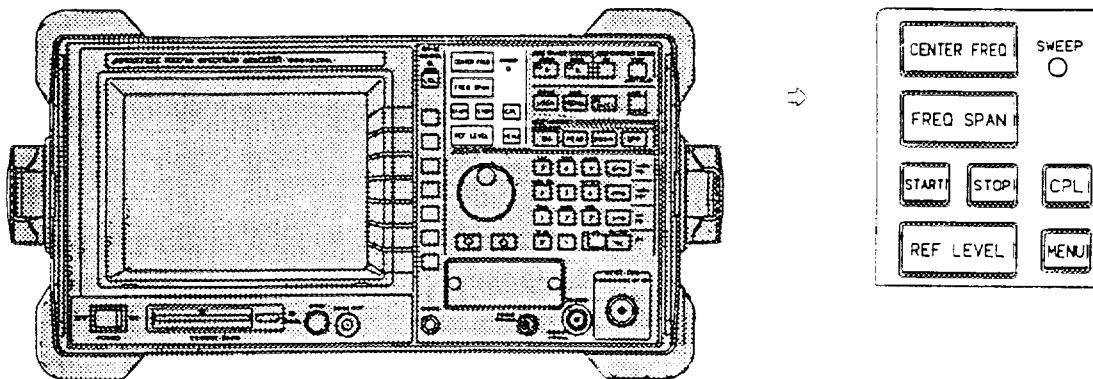

5.1.1 Center Frequency

The CENTER FREQ key, used with the SPAN key, sets the frequency range the instrument will measure. You can also use the START and STOP keys to accomplish the same task.

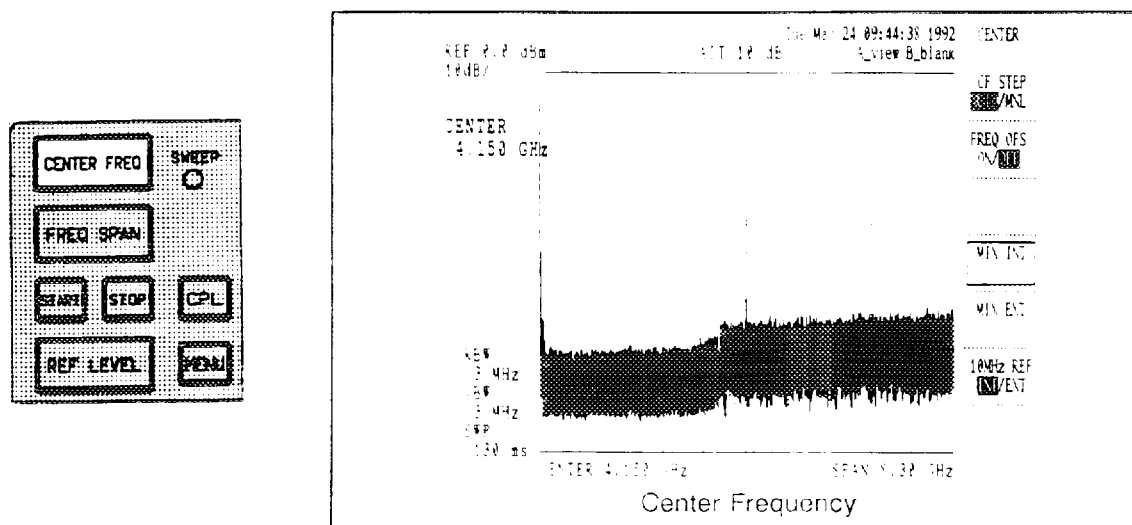

Figure 5.1-1 Center Frequency

CENTER FREQ

Use the CENTER FREQ softkey to set the center frequency. When you press this softkey the menu shown below appears. The center frequency can be from 0 to 8 GHz for the R3265, and from 0 to 26.5 GHz for the R3271 (the screen shows the current setting). Display resolution depends on the span, as shown in the following table.

NOTE

If span mode is set to LOG, you cannot modify the center frequency. Instead, use the START and STOP keys to adjust the frequency range.

Table 5.1-1 Center Frequency Display Resolution

Center Frequency Display Resolution	
1 MHz	(Span ≥ 1000 MHz)
100 kHz	(1000 MHz > Span ≥ 100 MHz)
10 kHz	(100 MHz > Span ≥ 10 MHz)
1 kHz	(10 MHz > Span ≥ 1 MHz)
100 Hz	(1 MHz > Span ≥ 100 kHz)
10 Hz	(100 kHz > Span ≥ 10 kHz)
1 Hz	(10 kHz > Span ≥ 200 Hz)
1 Hz	(Span = 0 Hz)

(1) Center Frequency Menu

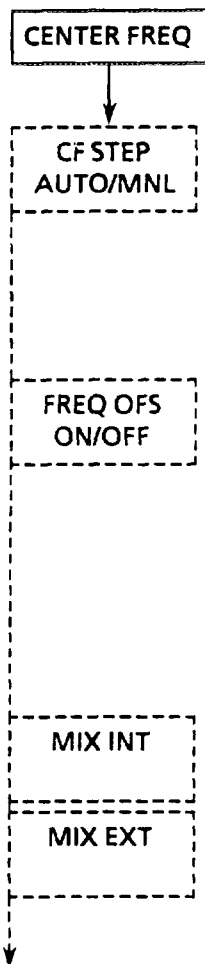

Use this softkey to set the step feature to automatic or manual. The step feature lets you conveniently step through the frequency range while maintaining a constant span. The step size is the amount by which the center frequency shifts when you press the step keys or rotate the knob. Select MNL (manual) to set the center frequency step size (the screen shows the current step size). Select AUTO to use a step size of 1/10 of the span setting.

Use this softkey to turn the frequency offset ON or OFF. You can use this feature to make relative frequency measurements. Select ON to set an offset frequency in the range from 0 to ± 100,000 MHz. If the setting is smaller than the display resolution, the value of the display resolution is used instead.

$$\text{Center Frequency (Display)} = \text{Center Frequency (Specified)} \mp \text{OFFSET}$$

Select OFF to cancel the offset.

Press this softkey to operate the analyzer using its internal mixer.

Press this softkey when using an external mixer to drive the analyzer. (You can set the center frequency in the range from 12.4 GHz to 325 GHz when using an external mixer.) The condition setting menu described below appears when you press this key.

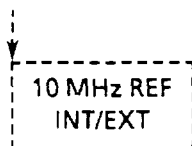

Use this softkey to select the frequency reference the analyzer will use. Select INT to use the analyzer's internal frequency reference. This reference has an accuracy of $\pm 2 \times 10^{-8}$ /day and $\pm 1 \times 10^{-7}$ /year. Select EXT to use an external frequency reference connected to the 10MHz REF IN/OUT terminal on the rear panel. The accuracy of the external reference determines the accuracy of the analyzer. The accuracy of the external reference should be $\pm 5 \times 10^{-6}$ /day, and the output level should be within the range -5 dBm to +5 dBm.

CAUTION

1. When using the analyzer's internal frequency reference, remove the external reference source from the rear panel terminal, or spurious signals will be generated.
2. When using an external frequency reference, be sure to connect the reference source.

(2) Setting the External Mixer Conditions (This operation cannot be used in the R3265A.)

Using an external mixer lets you increase the frequency range of the analyzer up to 325 GHz. To use an external mixer, set the mixer conditions and enter mixer correction data as described next.

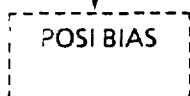
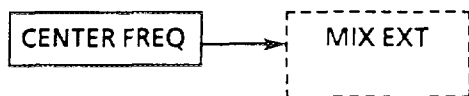

Use this softkey to adjust the mixer bias if the external mixer bias is positive. Set the bias with the data knob, step keys, or numeric keypad, and press Hz . The current value of the bias appears in mA in the active area at the upper left of the screen.

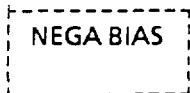

Use this softkey to adjust the mixer bias if the external mixer bias is negative. Set the bias with the data knob, step keys, or numeric keypad, and press Hz . The current value of the bias appears in mA in the active area at the upper left of the screen.

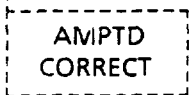

Use this softkey to enter the external mixer's conversion loss and frequency characteristics corrections. When you press this key, the menu described below appears for you to use to enter the correction data.

**BAND
SELECT**

Use this softkey to set the frequency bandwidth of the external mixer being used. Table 5.1-2 shows allowable frequency bandwidths.

After you press the softkey, use the data knob, step keys, or numeric keypad to select the bandwidth. When using the numeric keypad, specify a band number from Table 5.1-2. The band number and the mixing degree (N) appear in the active area in the upper left portion of the screen, and the start and stop frequency automatically adjust to the new frequency range.

Table 5.1-2 Allowable External Mixer Frequency Bandwidths

Band No.	Frequency Range (GHz)	Mixing Degree (N)
1	12.4 to 18.0	3
2	17.0 to 26.5	4
3	22.0 to 33.0	5
4	26.5 to 40.0	6
5	33.0 to 50.0	8
6	40.0 to 60.0	8
7	50.0 to 75.0	10
8	60.0 to 90.0	12
9	75.0 to 110.0	14
10	90.0 to 140.0	18
11	110.0 to 170.0	22
12	140.0 to 220.0	28
13	170.0 to 260.0	34
14	220.0 to 325.0	42

**BAND LOCK
ON/OFF**

Use this softkey to turn the BAND LOCK ON or OFF. When BAND LOCK is ON, you can set the center frequency and the start/stop frequencies only within the frequency range specified using the BAND SELECT softkey described above.

When BAND LOCK is OFF, the bandwidth automatically changes to one of the frequency ranges shown in Table 5.1-2; the exact range depends on the center frequency and start/stop frequency entered.

**SIGNAL ID
ON/OFF**

Use this softkey to turn SIGNAL ID ON or OFF. Using an external mixer bypasses the analyzer's preselector, which can cause spurious multiple spectra to appear. The SIGNAL ID function helps you identify the real signal from these false signals. When you turn on SIGNAL ID, the false signals shift their position while the real signal remains stable. When SIGNAL ID is ON, you cannot modify the spectrum display position.

SIGNAL
SEARCH

Use this softkey to search the real signal from the image signal and the real signal spectrum. Using this function enables to clear the real signal due to erase the image signal or reduce the level lower.

Using this function enables to set the SIGNAL ID ON/OFF to ON.

When the SIGNAL ID ON/OFF is set to OFF, this function is canceled.

(3) Selecting the External Mixer Correction



AVG LOSS
ON/OFF

Use this softkey to turn the average conversion loss function ON or OFF. When this function is ON, measurements are corrected by the conversion loss entered. When OFF, no correction is made.

Use the numeric keypad to enter the average conversion loss of the external mixer being used, and press

ENTER
Hz

LOSS: FREQ
EDIT

Press this softkey to open the table and menu used to enter the conversion loss data for the external mixer. This menu is described below.

LOSS: FREQ
ON/OFF

Use this softkey to turn external mixer correction ON or OFF. When ON, the analyzer uses the external mixer correction data specified

using LOSS: FREQ EDIT . When OFF, no corrections are made, though

the correction data remains in memory.

(4) Entering the External Mixer Correction Data

The external mixer correction data compensates for variations in different mixers. The data remains in memory until deleted. To enter the data, press the following keys in the sequence shown:

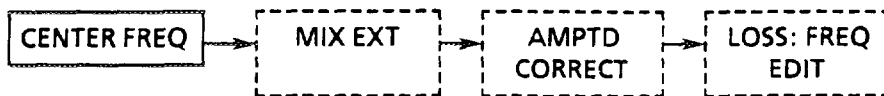

The following window appears for entering the correction data. Use the data knob and step keys to scroll through the data.

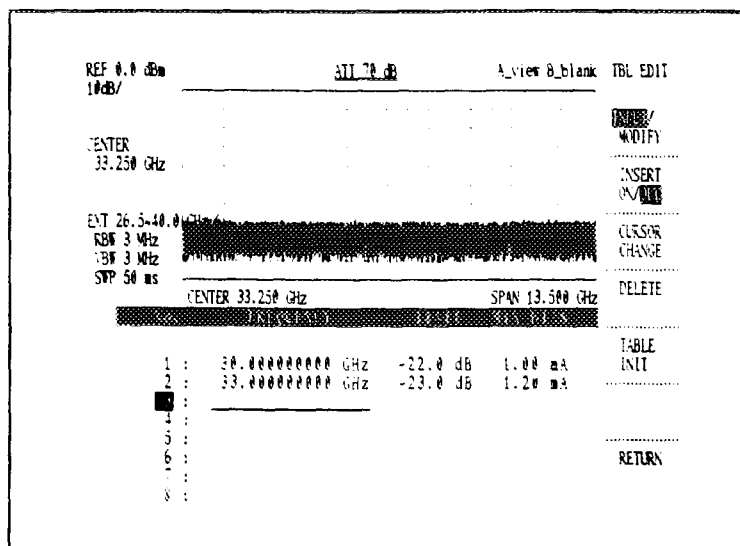
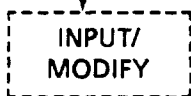

Figure 5.1-2 Entering the External Mixer Correction Data



Use this softkey to input or modify the underlined item in the correction data table.

When you select INPUT, you can enter the frequency, level, and bias current (in that order) to define each data point. The data entered is sorted in ascending order.

When you select MODIFY, you can modify the existing data. The modified data is also sorted in ascending order.



Set this softkey to ON to insert an empty line for data entry.

CURSOR CHANGE	Use this key to switch the input between frequency, level, and bias.
DELETE	Press this key to delete the cursor line.
Table INIT	Press this key to delete all data in the table. The analyzer prompts you to confirm this action.
RETURN	Press this key to close the data entry window and return to the preceding menu.

5.1.2 Frequency Span

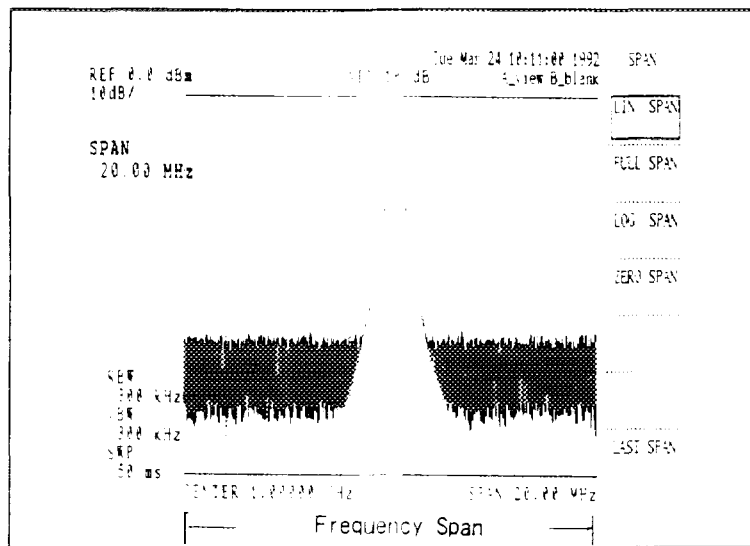
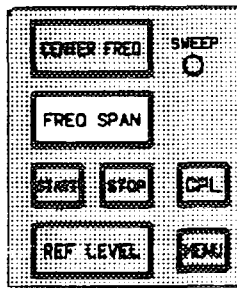

Figure 5.1-3 Frequency Span

FREQ SPAN Press this key to set the span and open the menu shown below. The analyzer's display resolution depends on the span, as shown in the following table. The screen shows the current setting.

NOTE

Certain settings cannot be modified if the span is set to LOG.

(1) Frequency Span Display Resolution

Table 5.1-3 Frequency Span Display Resolution

Frequency Span Display Resolution	
10 MHz (Span > 4000 MHz)
1 MHz (4000 MHz ≥ Span > 400 MHz)
100 kHz (400.0MHz ≥ Span > 40.1 MHz)
10 kHz (40.00MHz ≥ Span > 2.01 MHz)
1 kHz (2.000MHz ≥ Span > 401 kHz)
100 Hz (400.0kHz ≥ Span > 20.0 kHz)
10 Hz (20.0kHz ≥ Span > 2.00 kHz)
1 Hz (2.000kHz ≥ Span)

(2) Span Menu

Use the span menu to set the analyzer's frequency span. Access the menu by pressing the SPAN key.



Press this softkey to use a linear frequency span scale.

Press this softkey to set the full span of the analyzer. For the R3265A, this sets the center frequency to 4.15 GHz and the span to 8.3 GHz. For the R3271A, this sets the center frequency to 13.25 GHz and the span to 26.5 GHz.

Press this softkey to use a logarithmic frequency span scale. You must then specify the start and the stop frequencies in the combinations shown below by pressing the START and STOP keys.

Start Frequency	Stop Frequency
1 kHz	10 kHz
	100 kHz
	1 MHz
10 kHz	100 kHz
	1 MHz
	10 MHz
100 kHz	1 MHz
	10 MHz
	100 MHz
1 MHz	10 MHz
	100 MHz
	1000 MHz
10 MHz	100 MHz
	1000 MHz
100 MHz	1000 MHz

Press this softkey to set the analyzer to zero span mode. In this mode, the analyzer operates as a receiver fixed at the center frequency, and modulation can be measured in the time domain. (The sweep time determines the time window.) This setting is useful for measuring AM and FM signals with low modulation frequencies (see Chapter 4).

Press this softkey to set the frequency span to the previous value. This feature is useful when an incorrect span has been specified, or for alternating between two spans.

5.1.3 Start and Stop Frequency

The START and STOP keys set the analyzer's measurement range. You can use them as an alternative to using the CENTER FREQ and SPAN keys.

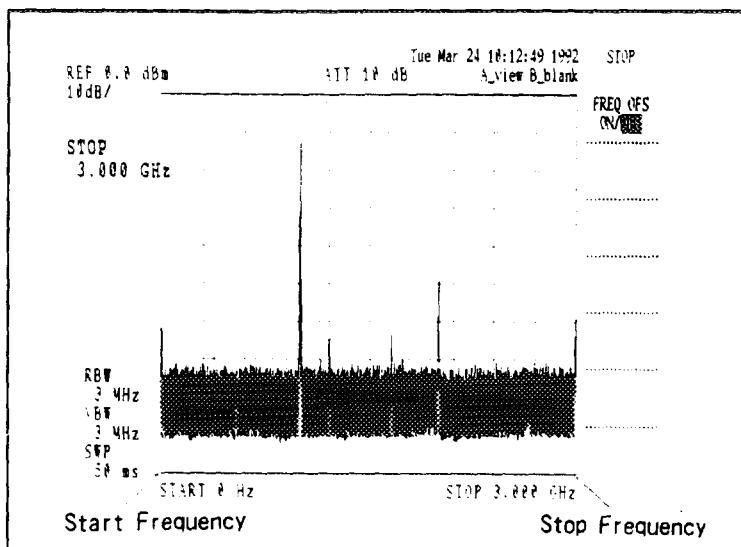
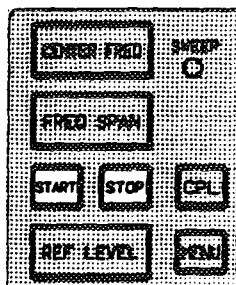

Figure 5.1-4 Start and Stop Frequency

START

Use this key to set the start frequency. This frequency can be from 0 Hz to 8GHz for the R3265A, or 0 Hz to 26.5 GHz for the R3271A. The preset value is 0 Hz for both the R3265A and R3271A.

stop

Use this key to set the stop frequency. This frequency can be from 0 Hz to 8GHz for the R3265A or 0 Hz to 26.5 GHz for the R3271A. The preset value is 8GHz for the R3265A or and 26.5 GHz for the R3271A.

NOTE

In log span mode, the start and stop frequencies can only have the discrete values listed under the LOG SPAN description above. If you enter another value, the setting jumps to the nearest discrete value.

FREQ OFFS
ON/OFF

Use this softkey to apply a frequency offset to the start and stop frequencies. Select ON to set an offset frequency in the range from 0 to $\pm 100,000$ MHz. If the setting is smaller than the display resolution, the value of the display resolution is used instead.

$$\text{Start (or Stop) frequency (display)} = \text{Start (or Stop) frequency (specified)} + \text{Offset}$$

Select OFF to cancel the offset.

5.1.4 Reference Level

The reference level setting determines the vertical scale the analyzer uses.

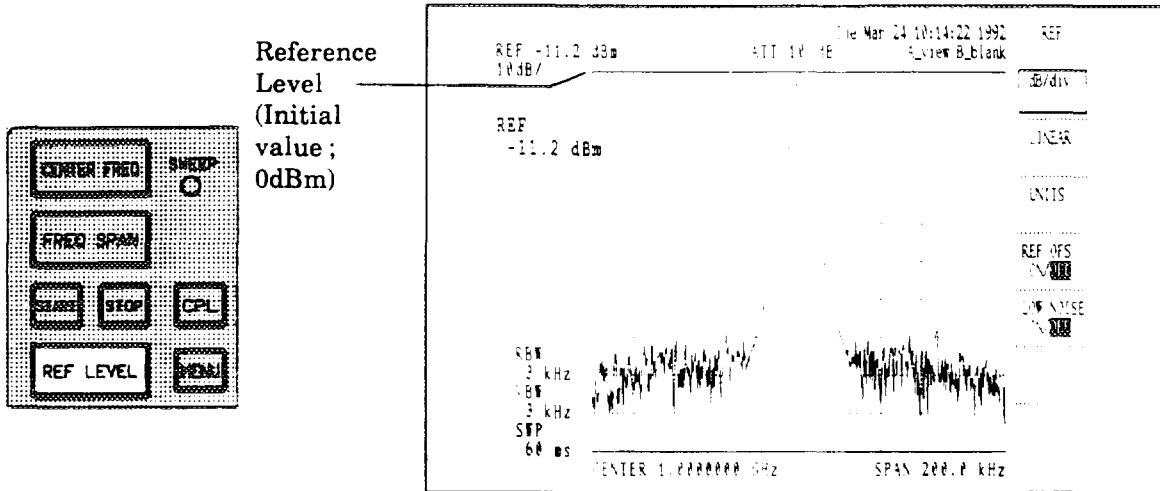
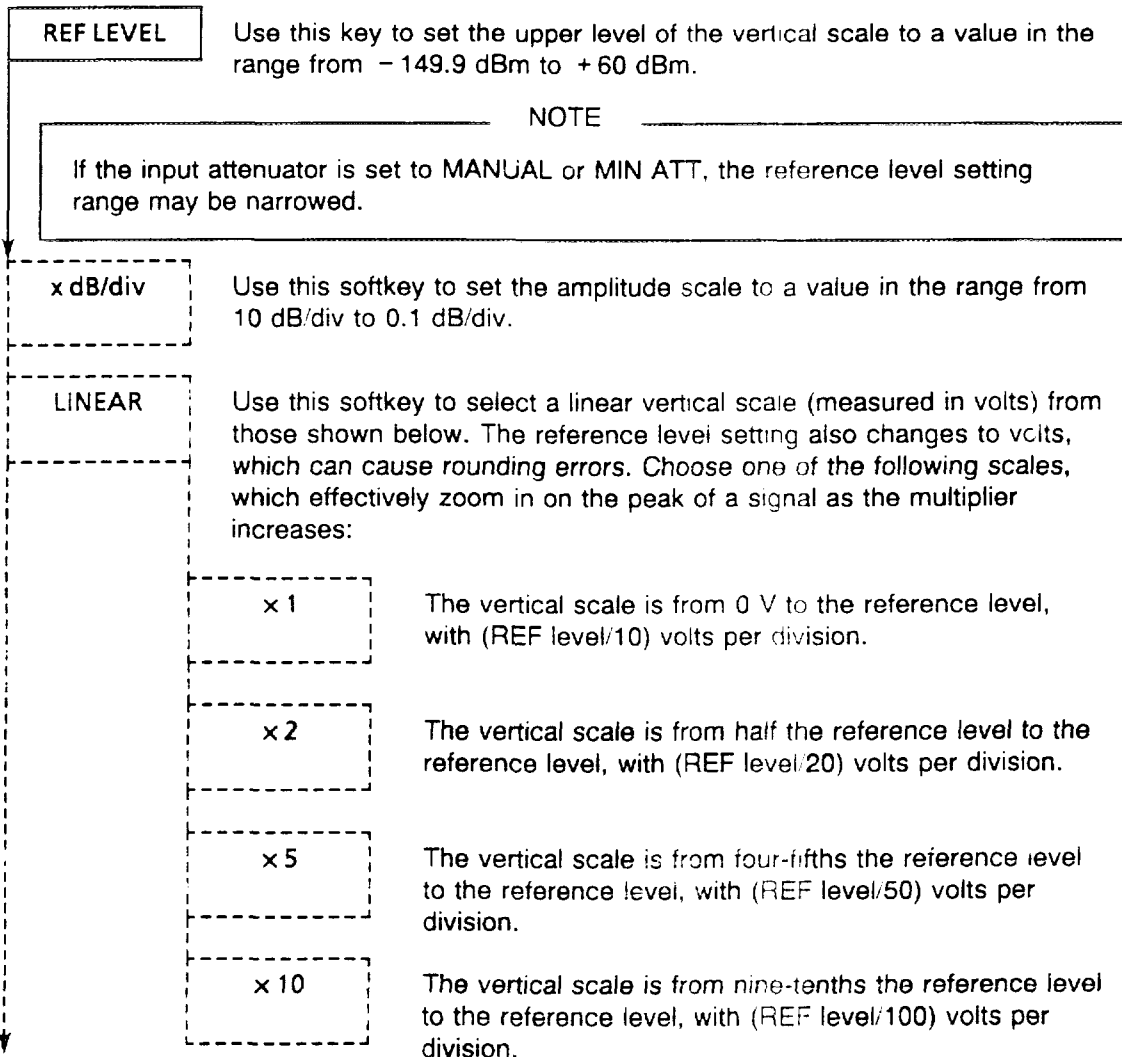
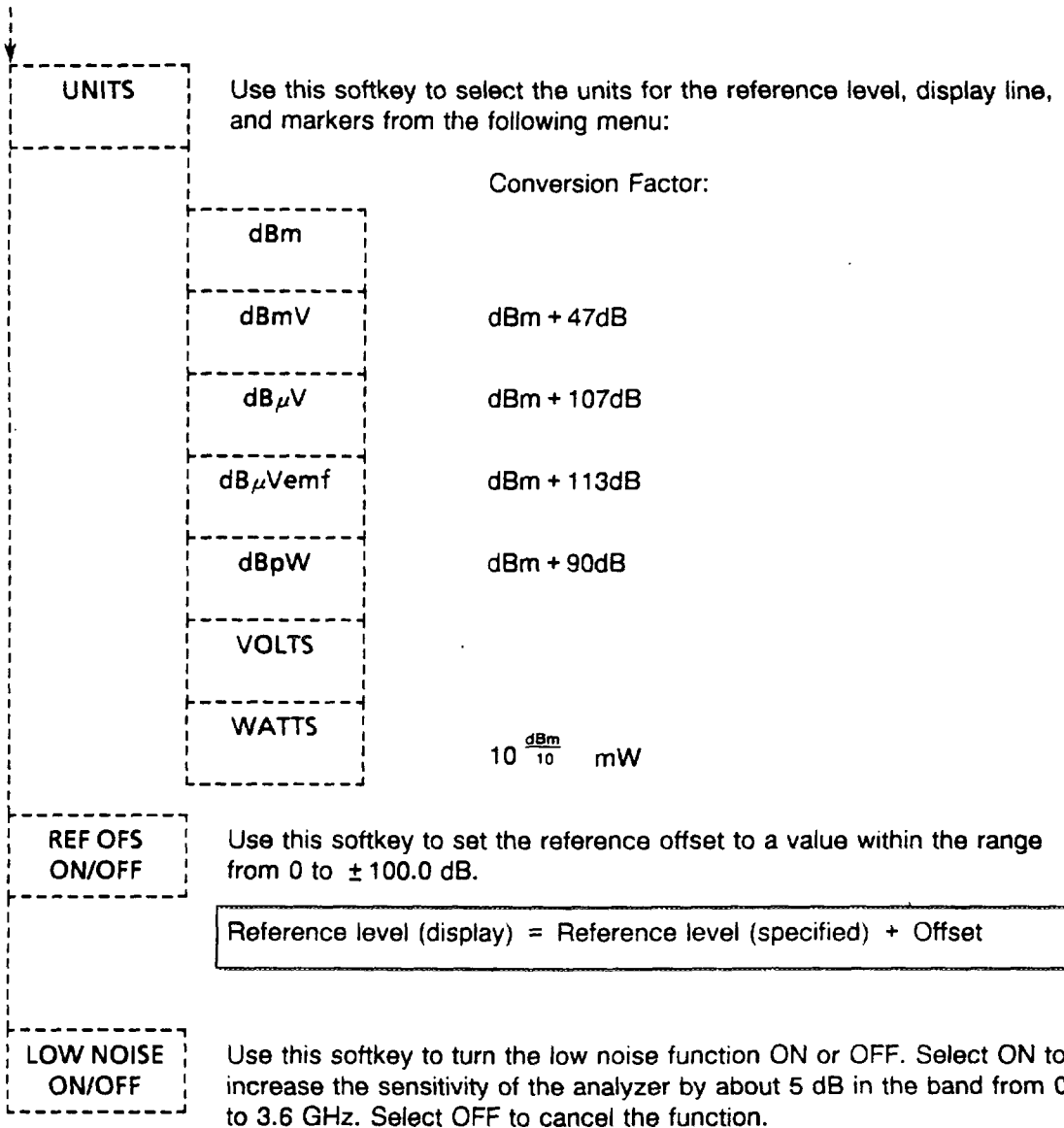

Figure 5.1-5 Reference Level





NOTE

1. The R3271A does not use the low noise function.
2. Set LOW NOISE to OFF when measuring distortion (otherwise the analyzer's tertiary modulation distortion or 1 dB gain compression deteriorates).

5.1.5 Coupling Functions

The coupling functions control the input section of the analyzer. They include the resolution bandwidth, video bandwidth, sweep time, and RF attenuator. Each of these functions can operate manually or automatically.

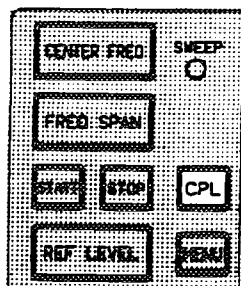

Resolution bandwidth (RBW)
 Video bandwidth (VBW)
 Sweep time (SWP)
 RF attenuator

(1) Resolution Bandwidth

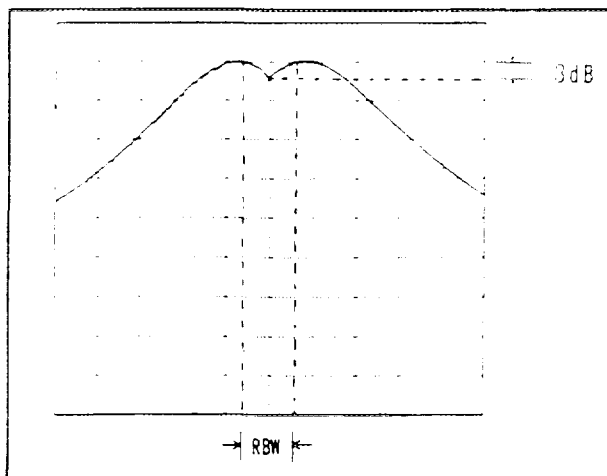
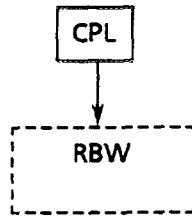

Figure 5.1-6 RBW: The Maximum IF Bandwidth That Can be Separated as Two Signals

The resolution bandwidth (RBW) is the analyzer's IF filter bandwidth. As the RBW is narrowed, spectrum peaks become slender and the resolution increases. This enables you to separate noise from the spectrum being measured, and to separate one spectrum peak from another. However, as resolution improves, measurement time increases.

If the sweep time becomes too short, measurements become less accurate and the message UNCAL appears on the analyzer's screen. To avoid this, increase the sweep time as you decrease the RBW. For lower RBWs, the analyzer uses a digital IF (see the DIGITAL IF softkey description below).



Use this softkey to set the RBW within the range from 10 Hz to 3 MHz. The initial value is AUTO, which automatically sets the optimal RBW depending on the Frequency span, as shown in Table 5.1-4.

Table 5.1-4 RBW Automatically Selected

Frequency span	RBW
Span \geq 200 MHz	3 MHz
200 MHz > Span \geq 60 MHz	1 MHz
60 MHz > Span \geq 20 MHz	300 kHz
20 MHz > Span \geq 6 MHz	100 kHz
6 MHz > Span \geq 2 MHz	30 kHz
2 MHz > Span \geq 300 kHz	10 kHz
300 kHz > Span \geq 100 kHz	3 kHz
100 kHz > Span \geq 30 kHz	1 kHz
30 kHz > Span \geq 10 kHz	300 Hz
10 kHz > Span \geq 5 kHz	100 Hz
5 kHz > Span \geq 1 kHz	30 Hz
1 kHz > Span	10 Hz

(2) Video Bandwidth (VBW)

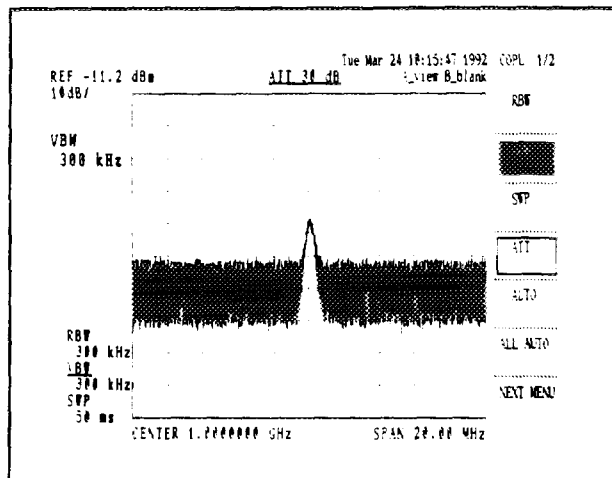

Figure 5.1-7 VBW = 300kHz

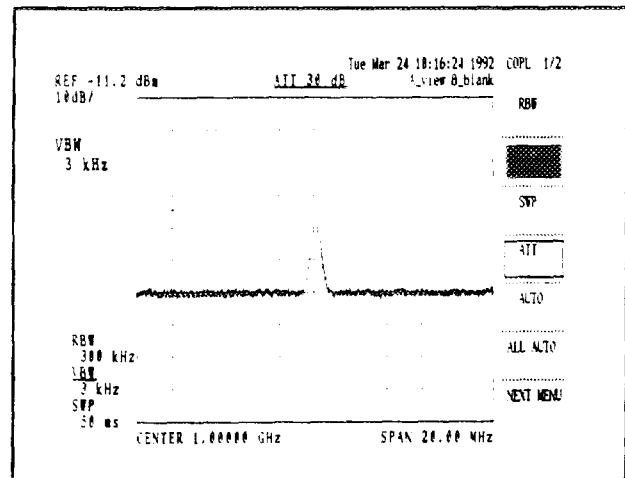
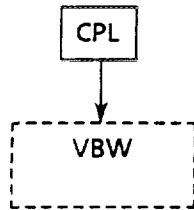

Figure 5.1-8 VBW = 3kHz

The video bandwidth feature enables you to detect a signal buried in noise. It uses a noise averaging process that requires inserting a low pass filter into the detected signal. This improves the signal to noise ratio by about 10 dB. To increase the efficiency of the averaging, set the VBW to 1/10 of the RBW or below.

If the VBW is set too narrowly, the signal level is lowered due to the time constant of the low pass filter, and the message UNCAL may appear. If this happens, increase the sweep time.



Use this softkey to set the VBW within the range from 1 Hz to 3 MHz. The preset value is AUTO, which sets the VBW equal to the RBW.

(3) Sweep Time (SWP)

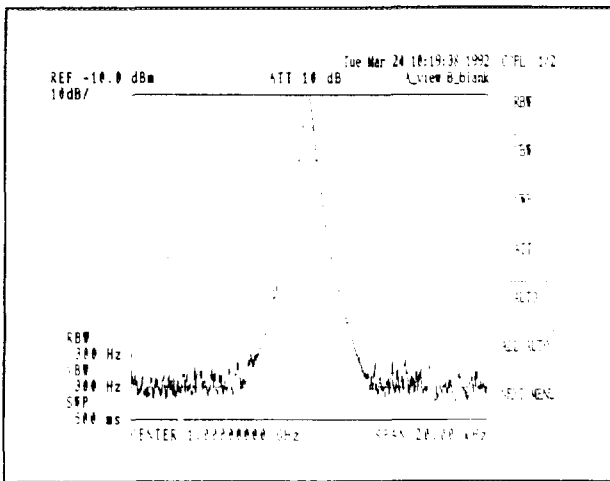

Figure 5.1-9 SWP = AUTO (500ms)

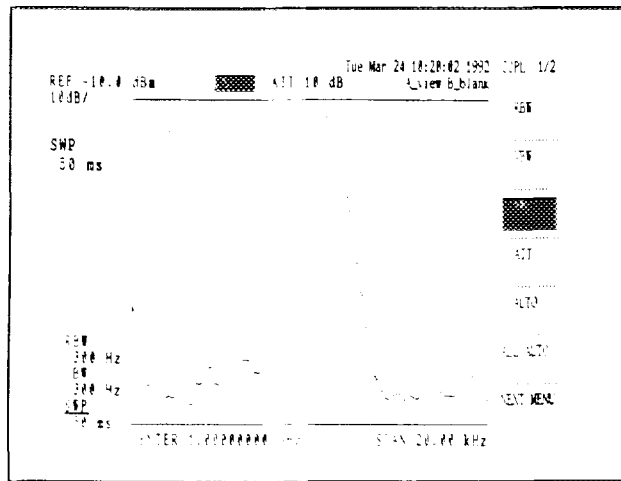
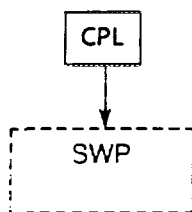

Figure 5.1-10 SWP = 50ms

If the sweep is set too fast for the signal to be displayed, the UNCAL error message appears on the analyzer's screen. If this happens, increase the sweep time. Other sweep functions are available under the MENU key sweep mode menu.



Use this softkey to set the sweep within the range from 20 ms to 1000 ms. The initial value is AUTO, which automatically selects a sweep that depends on the frequency span, RBW, and VBW, so that no level error occurs. If Span = 0 Hz (zero span mode), the setting range is 50 μ s to 1000 s.

The SWP AUTO value, the frequency span, the RBW, and the VBW are related as follows:

$$\text{Frequency span} / [\text{RBW} * \text{MIN}(\text{RBW}, \text{VBW}) * 0.5] = \text{SWP}$$

(4) Input Attenuator (ATT)

The attenuator lowers the input signal amplitude to prevent damage to the input block, to facilitate easy observation, and to prevent distortion.

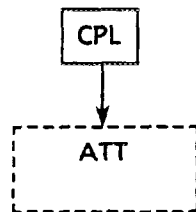

Use this softkey to set the ATT within the range from 0 to 70 dB.

However, if MIN ATT is ON, ATT cannot be set below MIN

ATT.

The preset value is AUTO (10dB), and the optimal ATT value is automatically set according to the reference level.

(5) AUTO Selection

The coupling functions can be individually set to auto mode so that the analyzer automatically chooses an optimal setting for the function.



To set a coupling function to AUTO, press the softkey for that function, then press AUTO. To set a coupling function to manual, press its softkey and enter a value with the shift keys, knob, or numeric keypad. Once a coupling function has been set manually, it appears boxed in the CPL menu and is underlined on the screen. For example:

RBW in data entry mode

RBW in manual mode (the RBW indicator at the lower left of the screen is underlined)

RBW in auto mode

Press this softkey to set all coupling functions to AUTO.

(6) Next Menu

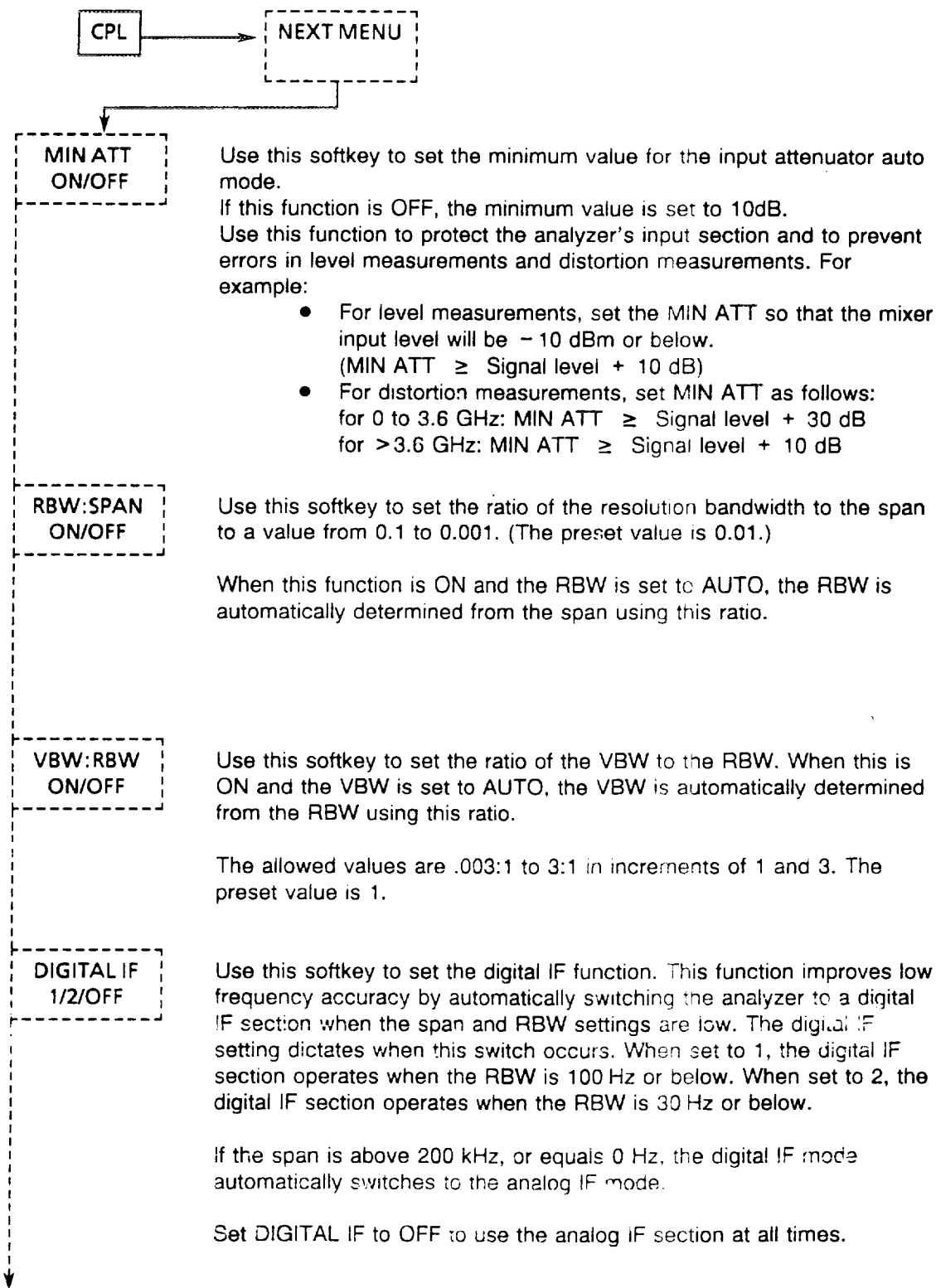

NOTE

1. When the digital IF section is operating, the functions listed in Table 5.1-5 cannot be used.
2. The digital IF dynamic range is reduced to about 75 dB in the input frequency range of $\pm 300\text{Hz}$.
3. The analog IF section is particularly sensitive to changes in temperature for an RBW of 30 Hz or 10 Hz. If you use the analog section for these low RBW frequencies, first calibrate the instrument using the CAL key. The bandwidth, signal level, and noise level are not accurate at 10 Hz RBW in analog IF mode. The screen shows "RBW *10Hz" to indicate this.

Table 5.1-5 Functions That Cannot Be Used in Digital IF

SWEEP TIME
VIDEO BW
MARKER CENTER
SWEEP TRIGGER
TRACE DET
WINDOW SWP
FULL SPAN
LOG SPAN
ZERO SPAN
EXT TRIGGER
SWEEP MODE
AUTO ZOOM

PREV MENU

Press this softkey to return to the previous menu.

5.1.6 Menu Keys

The MENU key opens softkey menus that control triggering, trace detection, the sweep, the display, and input/output.

(1) Trigger Menu

When taking measurements in zero span mode, use the trigger menu to select the appropriate triggering method. You can also use triggering to capture intermittent signals.

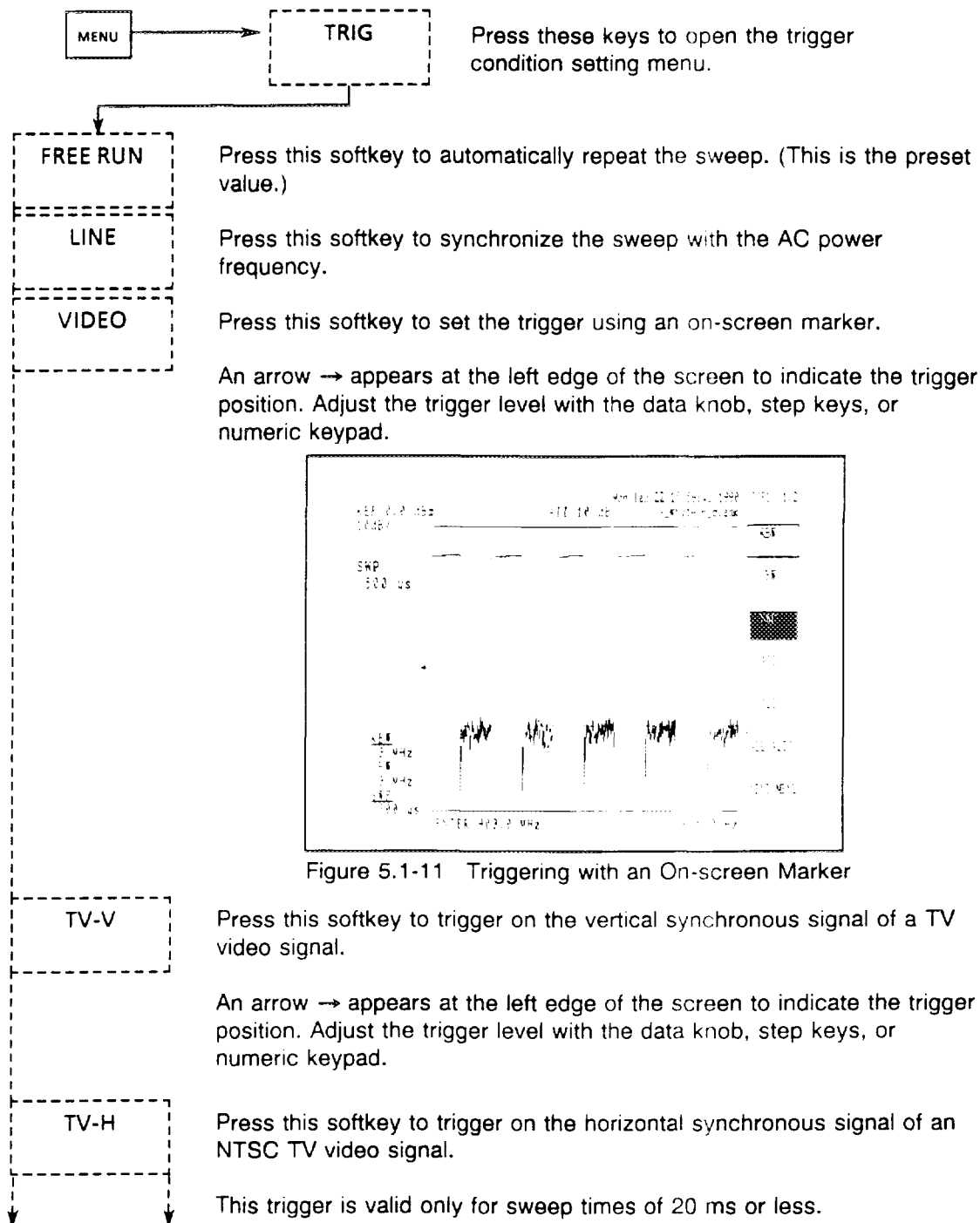
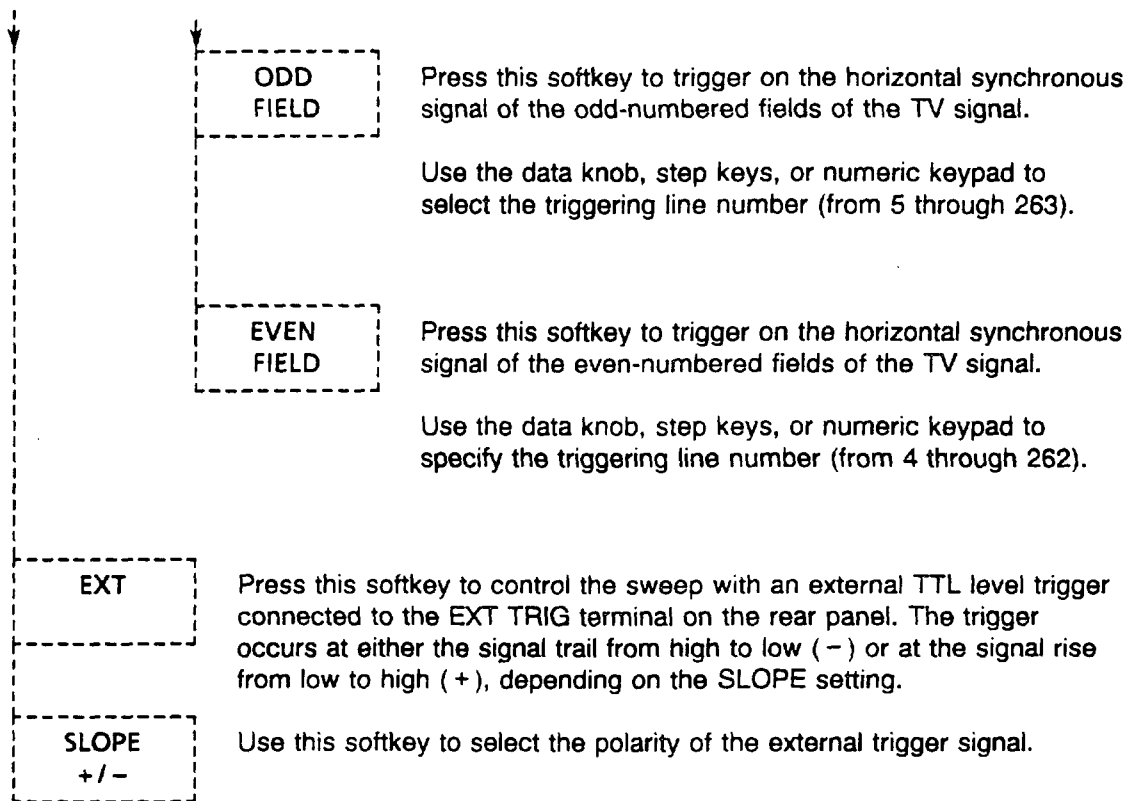
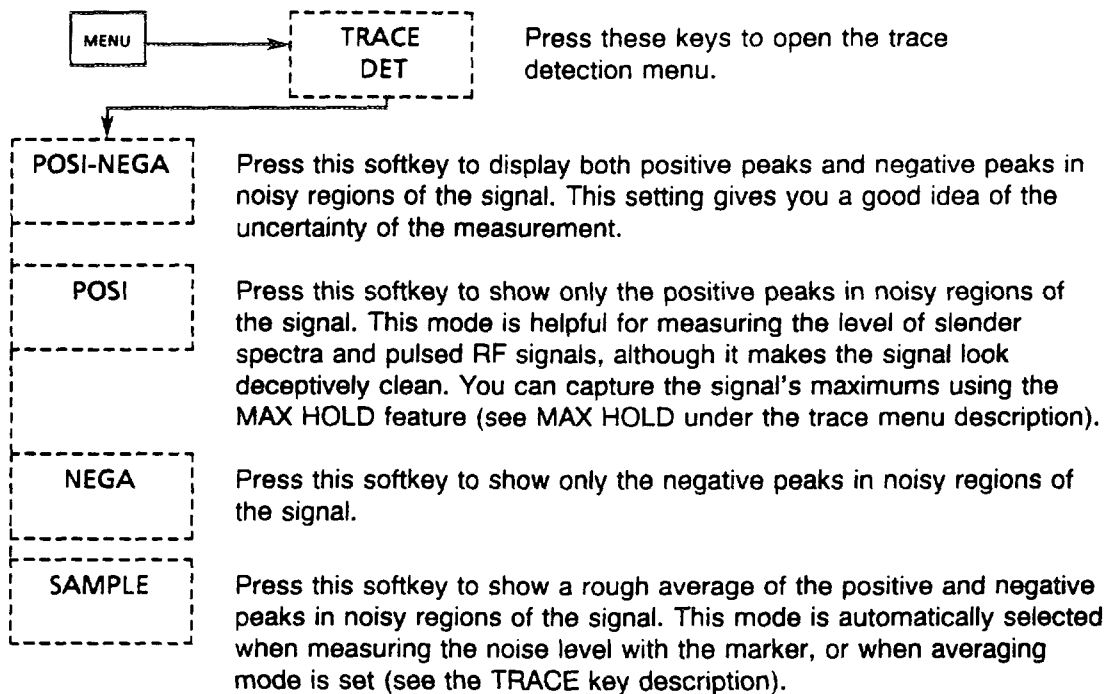

Figure 5.1-11 Triggering with an On-screen Marker



(2) Trace Detection Menu

Use trace detection mode to control how the analyzer displays noisy signals.



(3) SWEEP Mode Menu

Set the sweep time using the CPL key, and set other sweep features with the sweep mode menu.

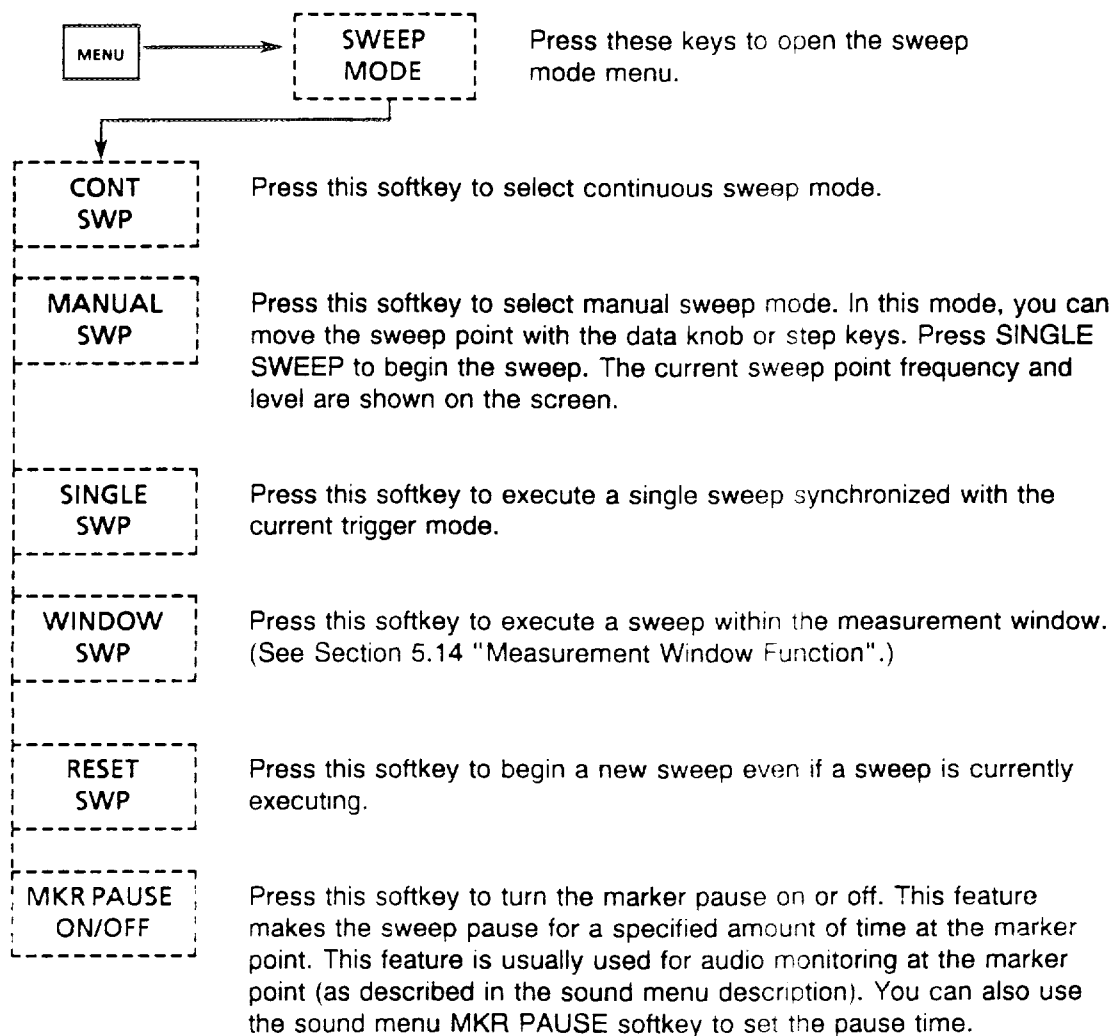

NOTE

You cannot use the MKR PAUSE function in ZERO SPAN mode.

(4) Sound Menu

Press the SOUND softkey to use the sound feature. A marker appears and the demodulated wave at the marker point can be heard through the internal speaker or the front panel headphone jack.

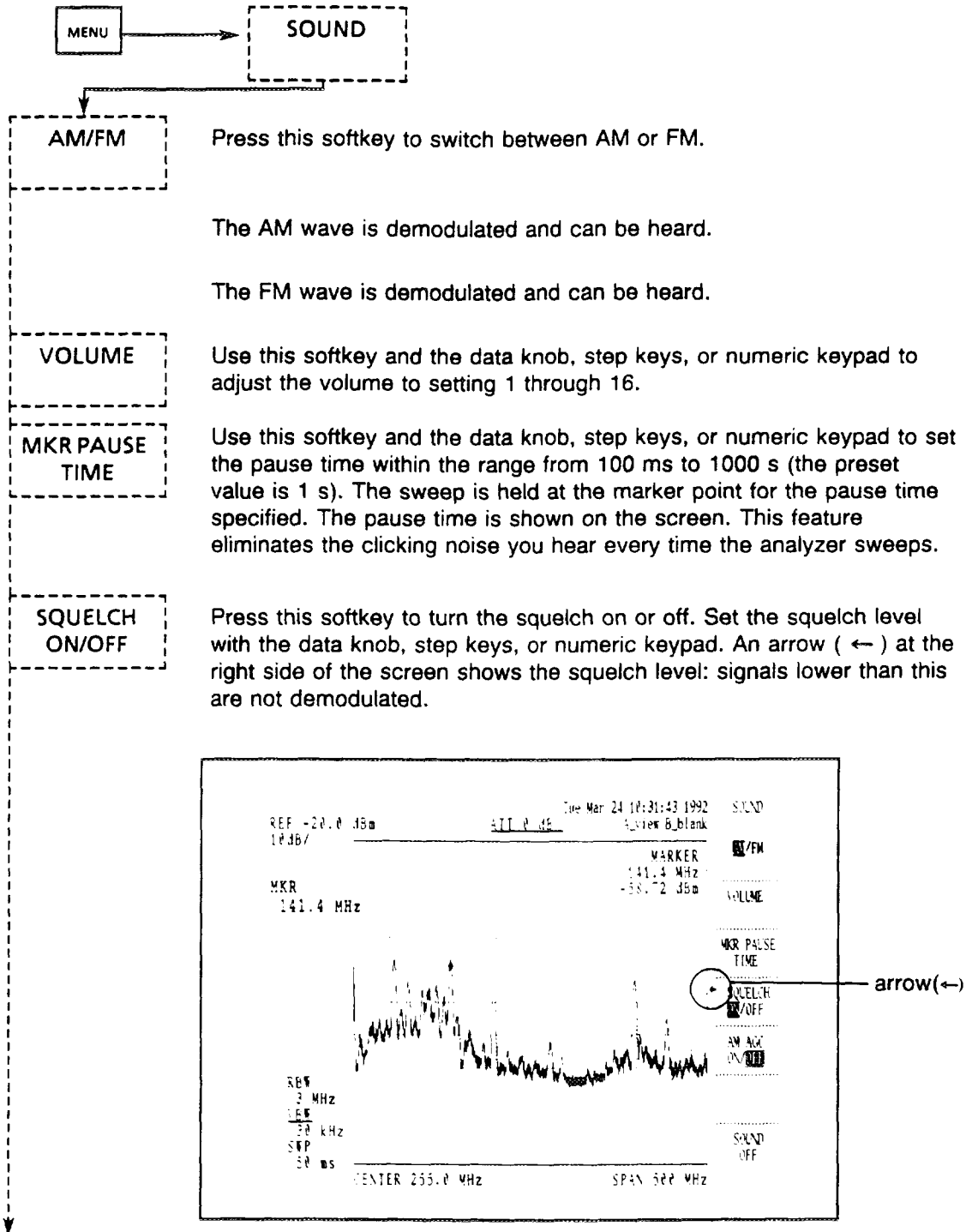

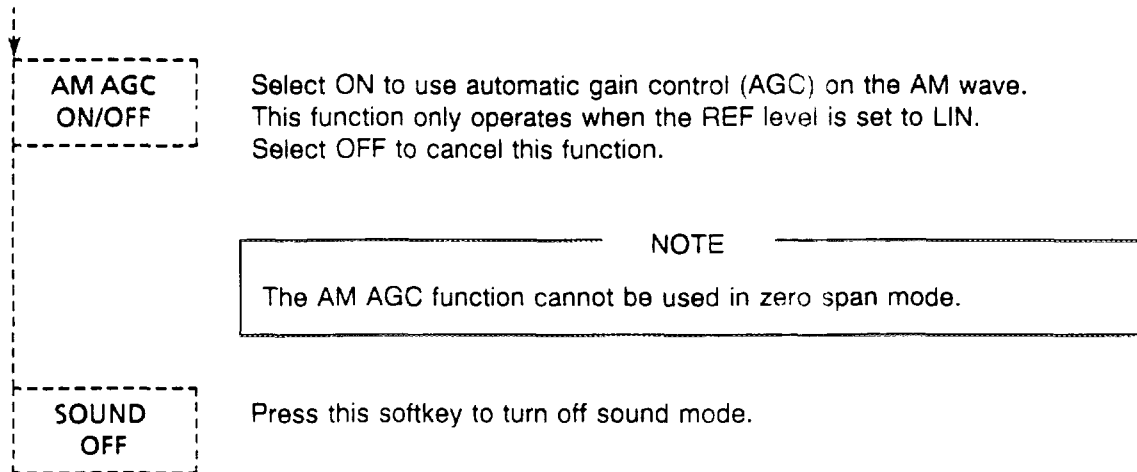



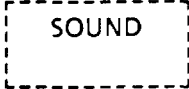

(5) Using the Analyzer as a Fixed Synchronous Receiver

Produce

① Set the marker at the spectrum to be monitored.

② Press   to turn on sound mode.

③ Set the pause time:

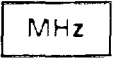
Press  and enter the pause time.(For example, if setting 10 seconds, press   .)

④ Select the demodulation type:

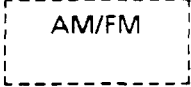
Press  to select AM or FM.

(The one reversed in black-white is selected.)

⑤ Adjust the sound volume:

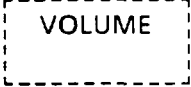
Press  and adjust with the data knob or step keys.

⑥ Set the squelch level.

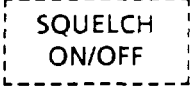
Press  to select ON, and use the data knob, step keys, or numeric

keypad to specify a squelch level higher than the noise level.

The squelch level is indicated with an arrow ← at the right side of the screen.

- ⑦ Set the sound mode to OFF.



(6) Setting the Display Line

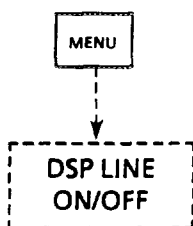

Use this softkey to turn the display line on and off. The display line is a horizontal cursor line you can use for comparing waveform levels. You can set the display line anywhere between the lowermost level and the reference level. (The preset value is -50 dBm.)

(7) Selecting the Display Features

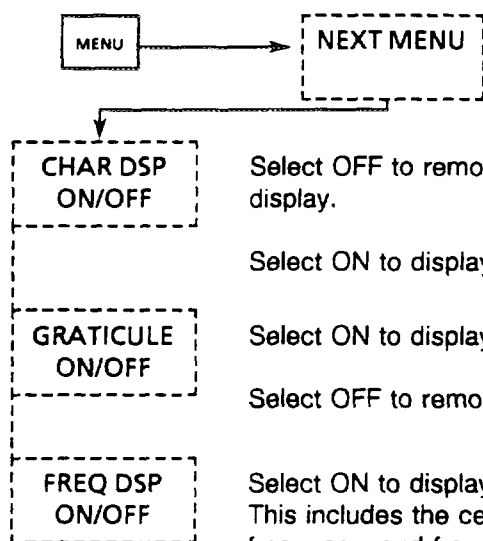

(8) Selecting Input/Output Types

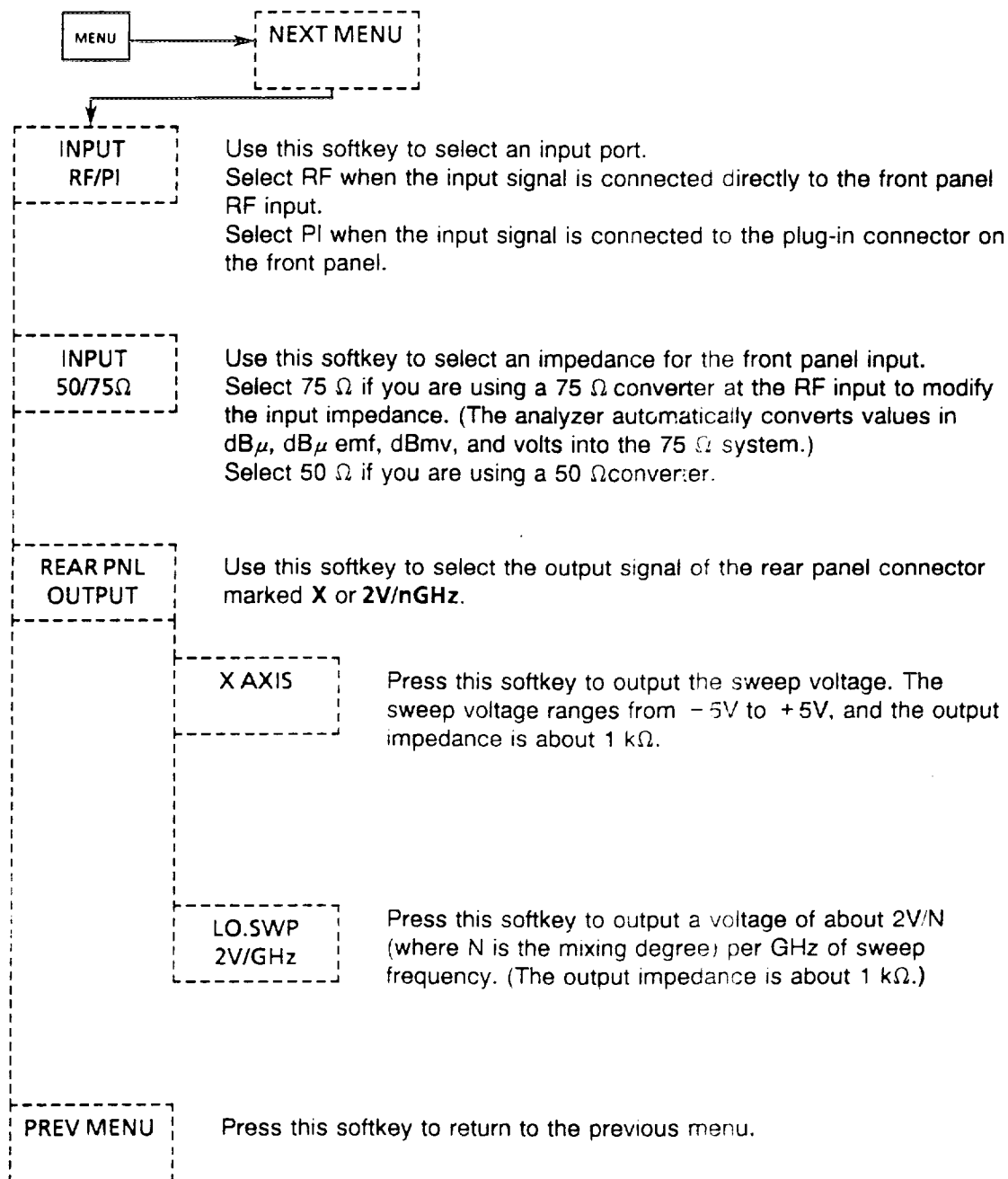

5.2 Trace Section Functions

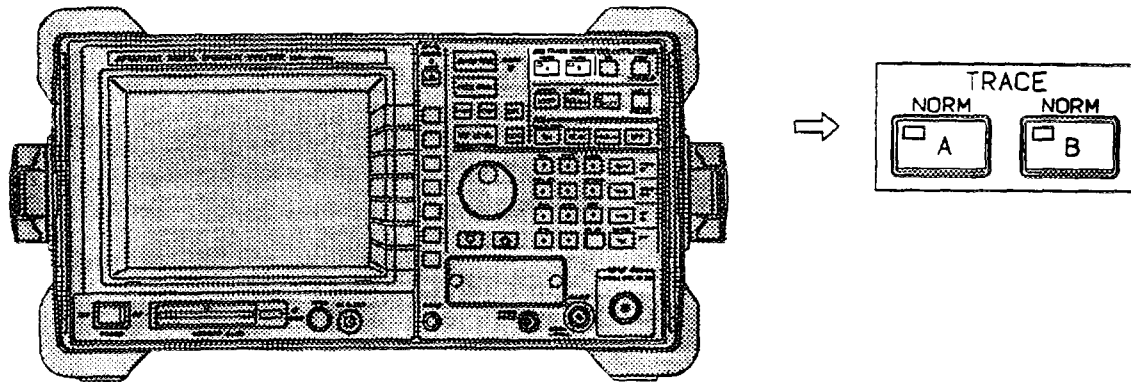

The analyzer has two trace memories: A and B. Each trace can be set to write the results of the current sweep or to view the results of a previous sweep. You can set both traces to write at the same time. The trace memories are not saved after you turn the power off, although the trace data can be stored in internal memory locations or on the memory card. The trace section provides an averaging mode to reduce noise, and has various other waveform comparison and calculation functions.

The analyzer handles each trace as digital information. The original analog signal is input through the RF/IF section, detected by the LOG/LIN amplifier, and then digitized for display. The digital data is stored in trace memory and displayed under CPU control. The CRT display is 701 pixels wide and 401 pixels high; each horizontal point has one level data point making up the trace.

NOTE

1. Averaging mode (with sample trace detection mode) is not available during MAX HOLD (POSI trace detection mode) or MIN HOLD (NEGA trace detection mode) measurements.
2. Conversely, MAX HOLD (POSI trace detection mode) or MIN HOLD (NEGA trace detection mode) measurements are not available during averaging measurements (which use SAMPLE trace detection mode).

Traces A and B have identical softkey menus. The following description of trace A also applies to trace B.

(1) Trace Mode

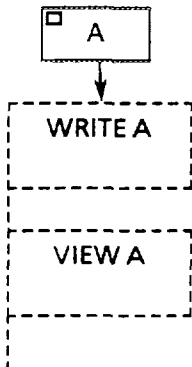

Press this softkey to rewrite trace memory A with each new sweep. The results appear on the screen.

Press this softkey to stop rewriting trace memory A and display the current memory contents. If trace A was previously in BLANK mode, trace A appears on the screen again.

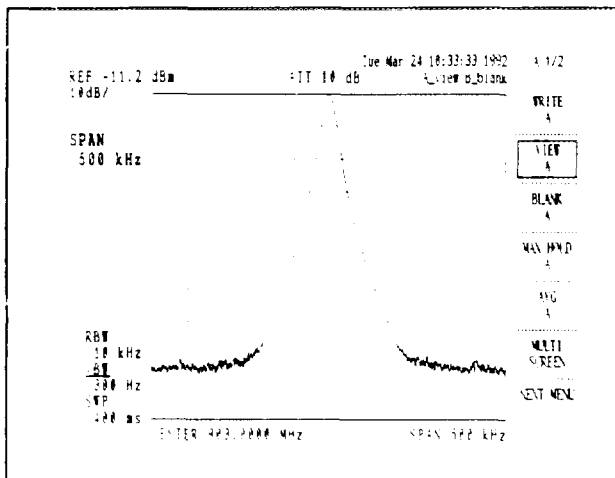

Figure 5.2-1 Basic Waveform in VIEW Mode

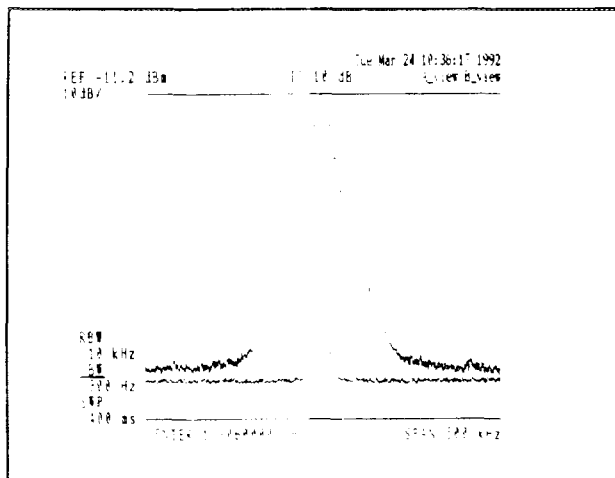
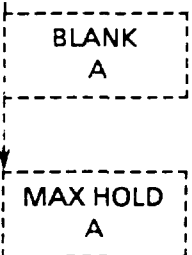

Figure 5.2-2 Second Higher Harmonics in WRITE B



Press this softkey to remove trace A from the screen. The trace data remains in memory and can be redisplayed by selecting view mode for trace A.

Press this softkey to make a trace of the maximum amplitude levels over time. The analyzer then compares each point on the frequency axis to the new data from the current sweep, saves the greater of the two, and displays the results on screen.

In this mode, trace detection mode is automatically set to POSI (see Trace Detection Mode under the MENU key description).

(2) Averaging Mode

In averaging mode, the analyzer averages the amplitude of each existing data point with the new amplitude from the latest sweep. It then replaces the old amplitude value with the new averaged value. Averaging can improve the signal-to-noise ratio more quickly than noise reduction using the video bandwidth feature. Averaging also allows you to perform quantitative analysis of random components and to measure signals buried in noise. In averaging mode, the trace detection mode is automatically set to SAMPLE.

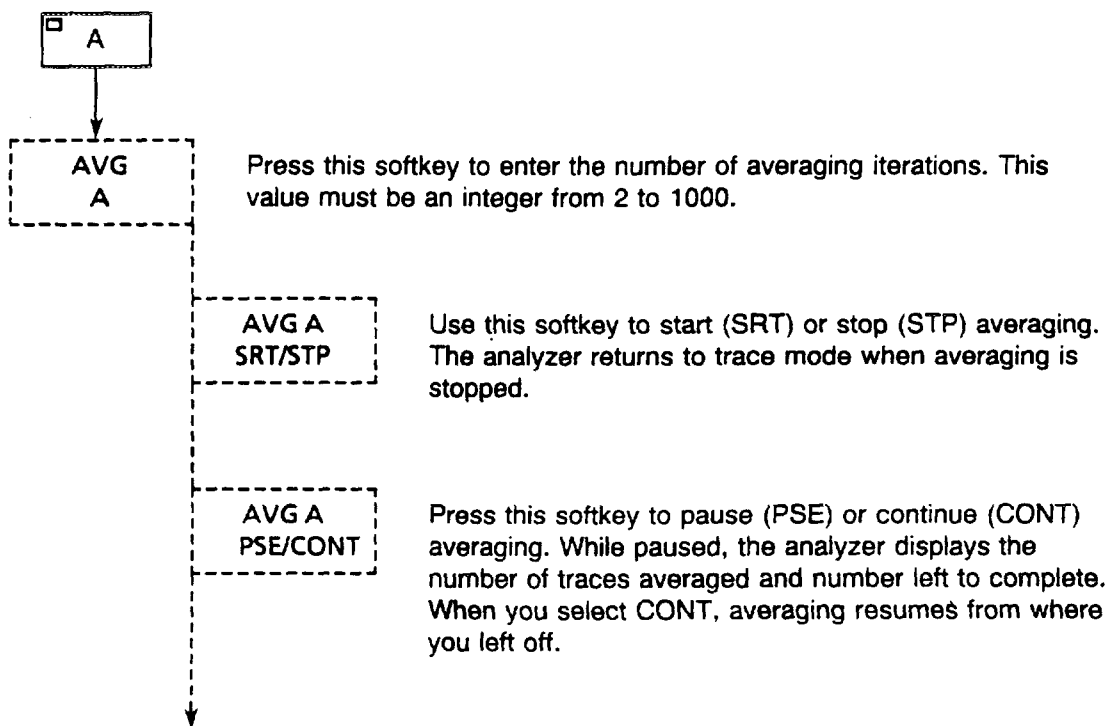

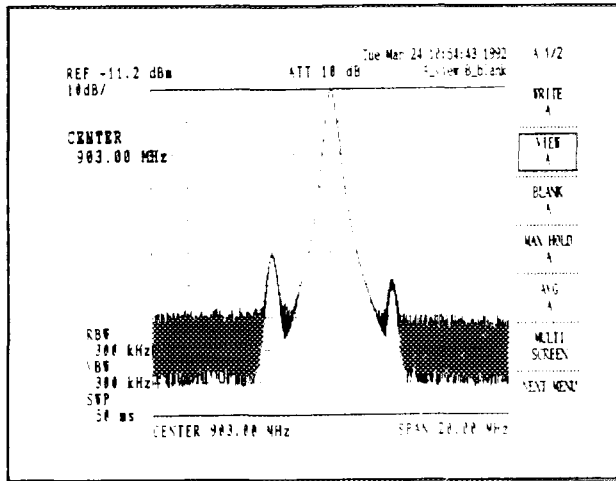

Figure 5.2-3 AVG = None

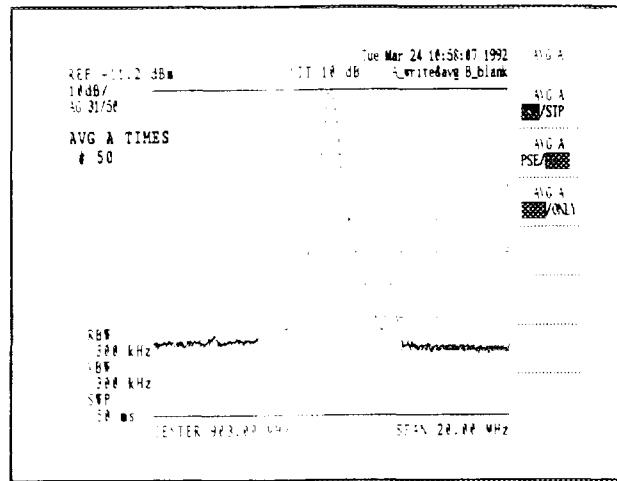

Figure 5.2-4 AVG = 31st

AVG A
CONT/ONLY

Use this softkey to select how long the analyzer stays in averaging mode. Select continuous (CONT) to have the analyzer continuously average new data with existing data. The analyzer uses formula 1 shown below. Select ONLY to average only the set number of averaging iterations, using formula 2. When complete, the analyzer returns to view mode.

Averaging Formulas

If $N \geq n$: Formula 1: $\overline{Y_n} = \text{Sigma}/n$

If $N < n$: Formula 2: $\overline{Y_n} = \{(N - 1) \cdot \overline{Y_{n-1}}\} / N + Y_n / N$

n :	The number of averaging iterations completed
N :	The number of averaging iterations specified
Y _n :	nth Trace data
$\overline{Y_n}$:	nth Average data
$\overline{Y_{n-1}}$:	(n-1)th Average data
Sigma:	Sum of data up to nth point

(3) Normalize Mode

The normalize function displays the difference between the input signal and a set of correction data stored in memory, plus the value of a display line. (The correction data is obtained from a signal saved as a reference. See SAVE CORR below.)

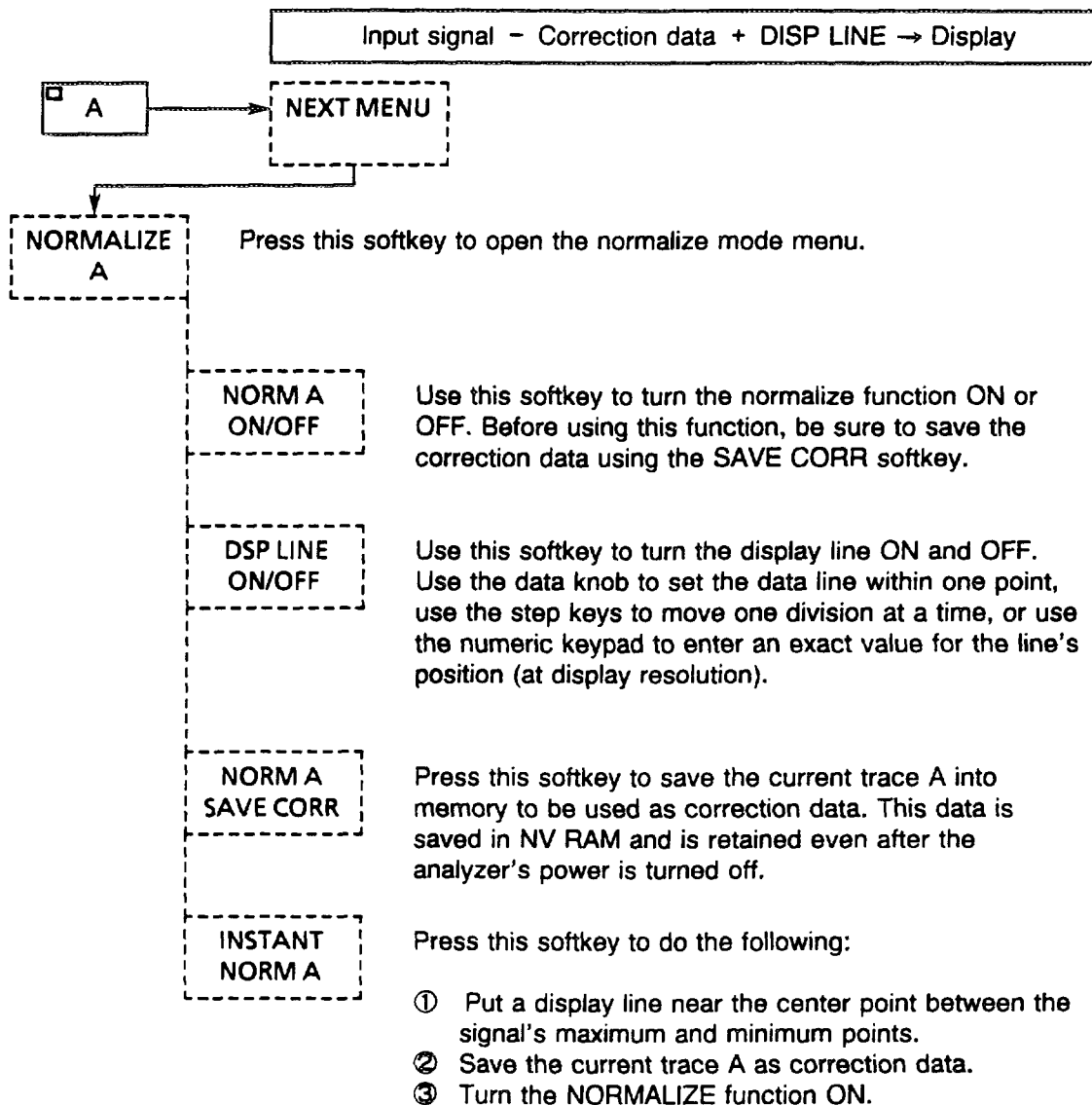

(4) Calculation Mode

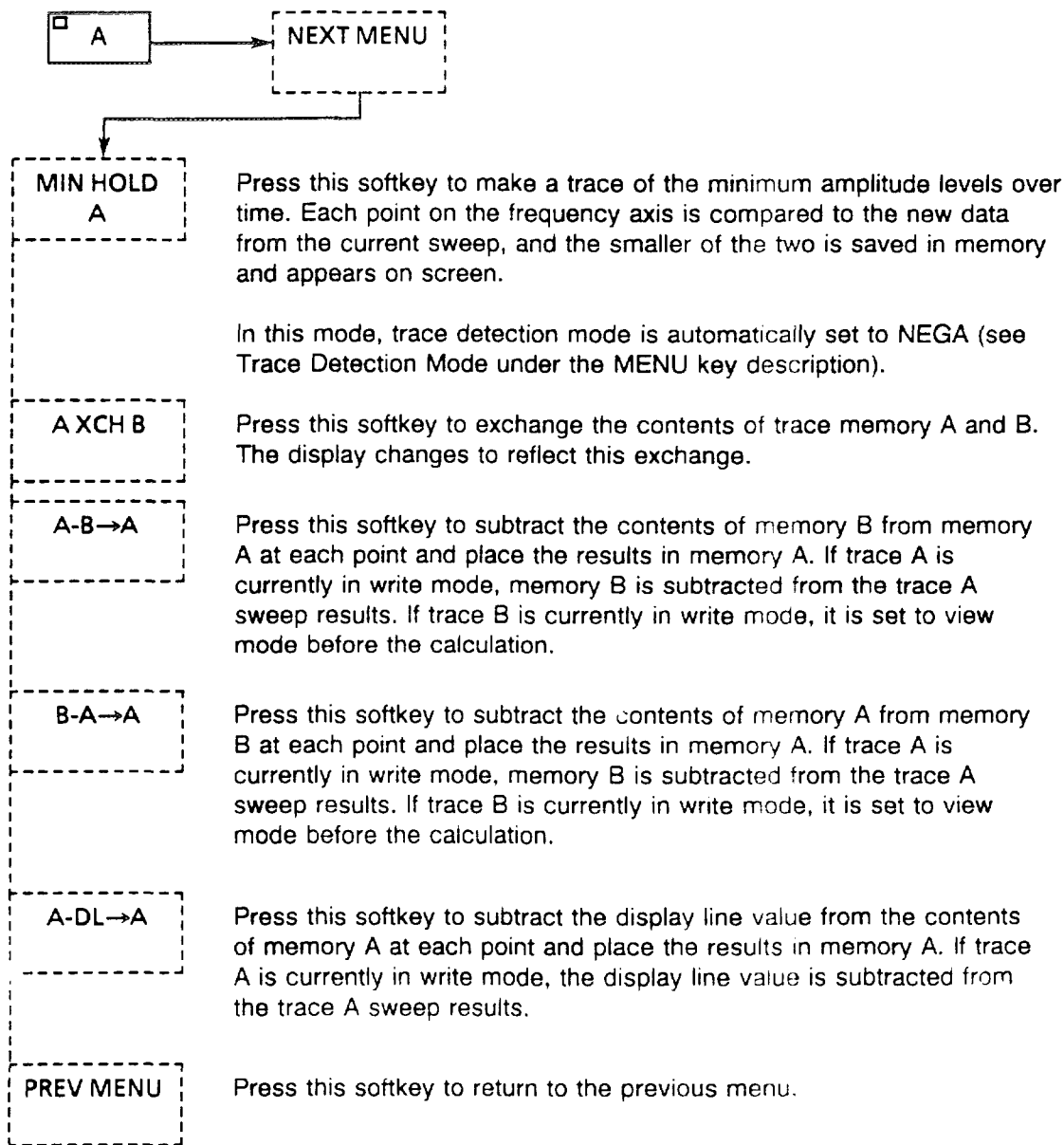

(5) Split-Screen Mode

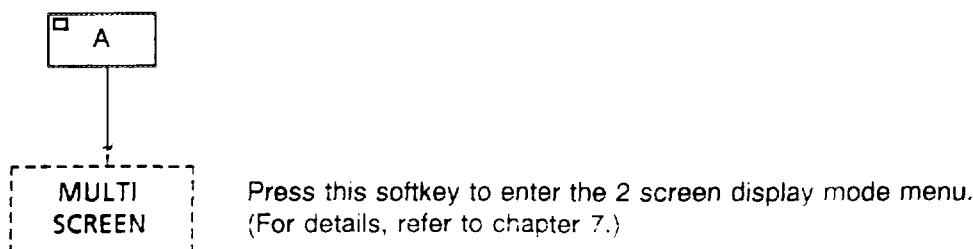

5.3 Marker Section Functions

The marker function enables you to superimpose normal markers or a delta marker (for relative measurements) on the waveform displayed on the screen. The analyzer then displays the frequency and amplitude at the marker position. In addition, the analyzer enables you to use markers for signal tracking and finding peaks, and allows you to send marker data to another function.

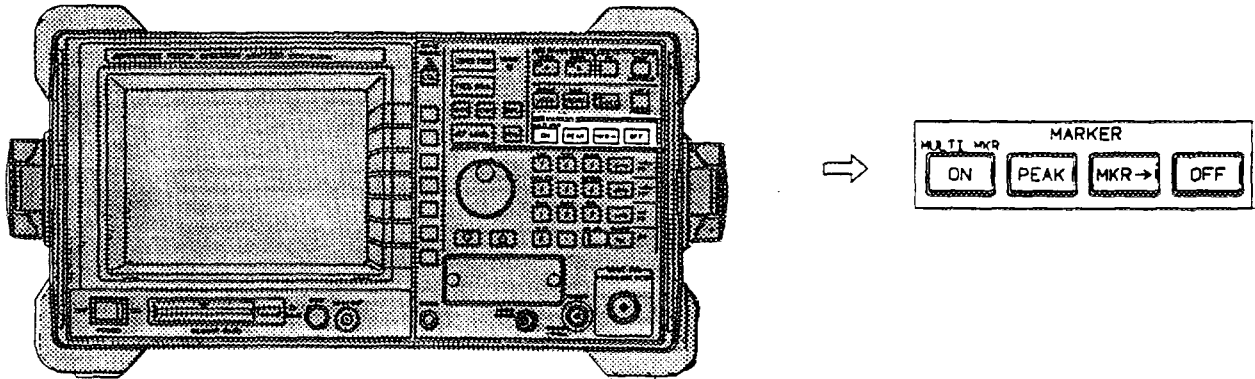

5.3.1 Marker ON

Press the ON key to turn on the normal marker and open the marker menu. The menu contains softkeys for using the delta marker, frequency counter, signal tracking, noise measurement, amplitude measurement, auto-peaking, and display line features.



(1) Normal Marker and Delta Marker

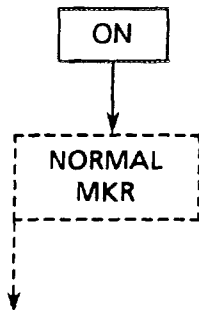

Press this softkey to turn on the normal marker (indicated by \blacklozenge). The frequency and the amplitude at the marker point appear on the screen. Adjust the marker with the data knob or step keys, or enter a specific frequency with the numeric keypad.

△ MKR

Press this softkey to fix the delta marker on the waveform, then rotate the knob to position the normal marker for measurements relative to the delta marker. The screen shows the difference in the frequency and the amplitude between the delta and normal markers. Adjust the normal marker with the data knob or step keys, or enter a specific frequency with the numeric keypad.

NORMAL MKR

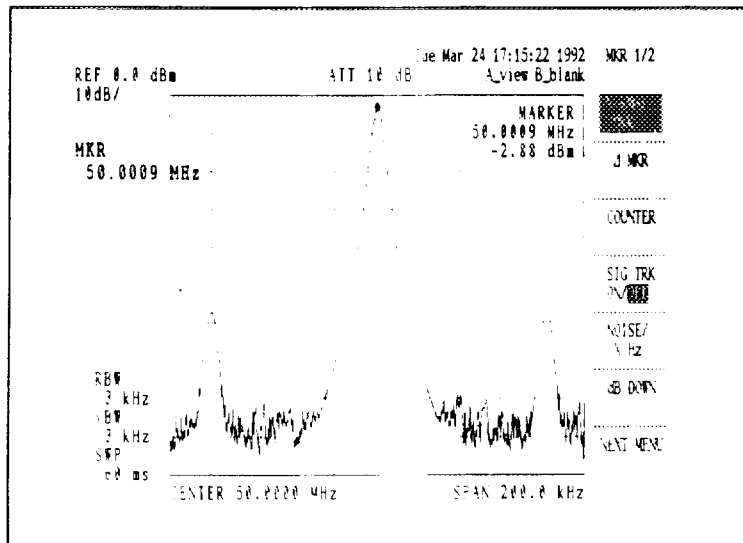

Figure 5.3-1 Normal Marker

△ MKR

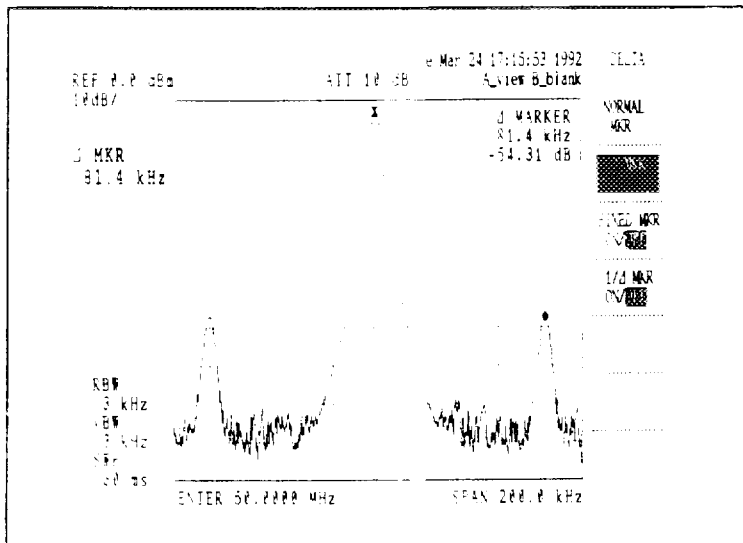
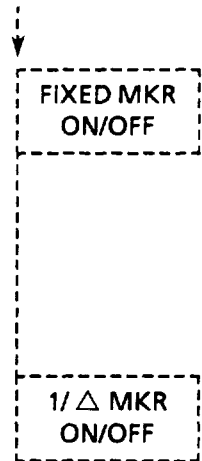

Figure 5.3-2 Delta Marker



Select ON to fix the delta marker at the current frequency and amplitude. These values are stored in memory and are used as reference values the next time this function is turned on, even if the center frequency and the reference level have been changed.

Select ON to display the reciprocal of the delta marker value. This function is useful for determining the modulation frequency of a demodulated wave in zero span mode, as described in Chapter 4.

How to Shift the Marker Between Trace A and B

Press A to shift the active marker to point ① on trace A.

Press B to shift the active marker to point ② on trace B.

(Note that the delta marker does not move.)

(2) Frequency Counter Function

The normal marker only makes rough frequency measurements based on the display data. The frequency counter function lets you make precision frequency measurements using the analyzer's internal frequency counter.

If the marker point is higher than the noise level by 25 dB or more, the analyzer measures the frequency of the signal containing the marker instead of the frequency at the marker position, and you do not need to set the marker exactly at the spectrum peak. However, the amplitude indicated is the amplitude at the marker point. To make precision frequency measurements exactly at the marker position, select the marker counter function described below.

You can set the frequency counter resolution as low as 1 Hz. However, as the counter resolution decreases, the gate time becomes longer, and as a result the sweep time increases. The frequency counter function cannot be used when the SIGNAL TRACK function is operating.

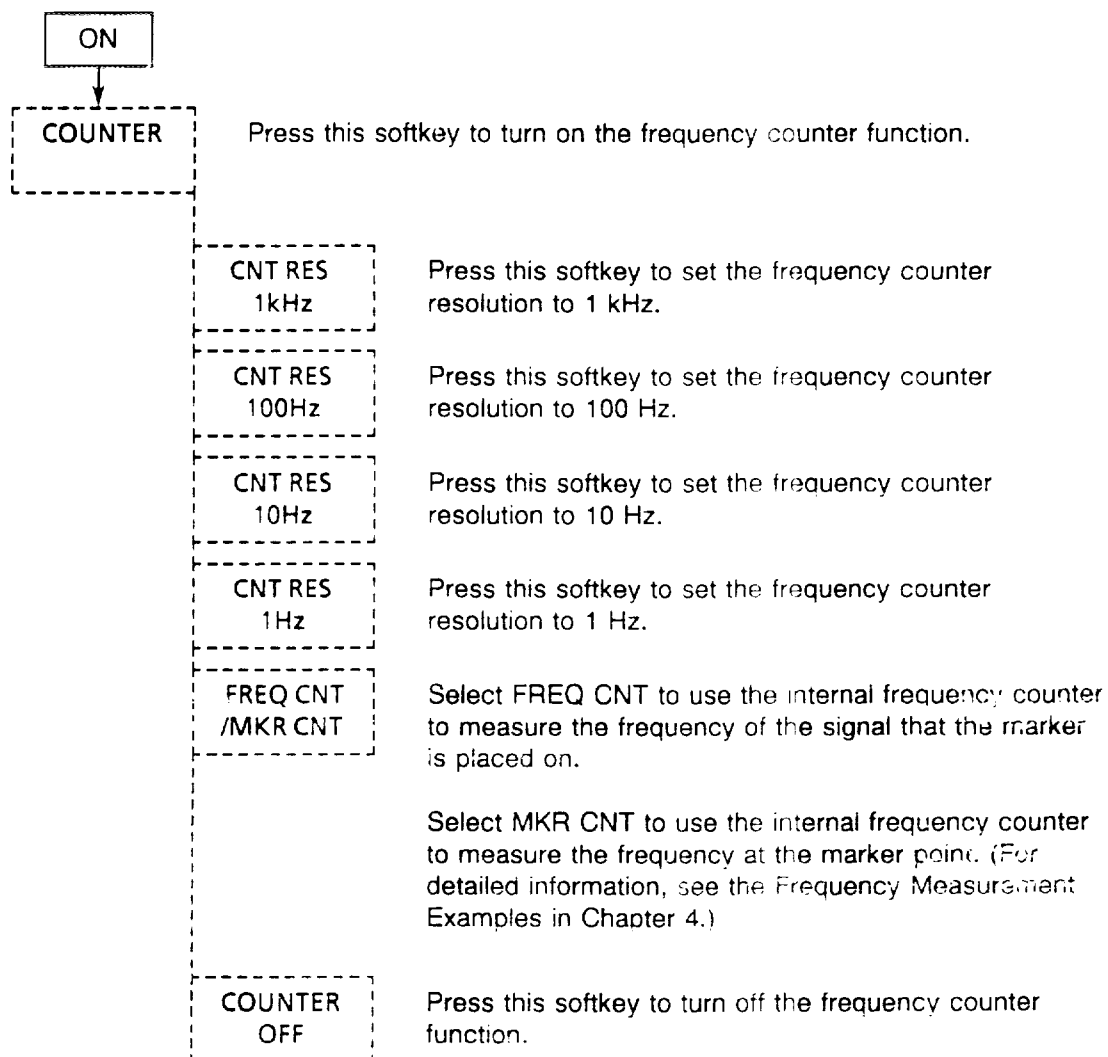

(3) Signal Track Mode

In signal track mode, the marker and the center frequency setting follow the signal as it drifts, so that the signal is always centered on the screen. (If the signal drifts off-screen within one sweep, it may not be tracked.)

If you narrow the span in signal track mode, the signal tracking function changes the center frequency to keep the signal centered.

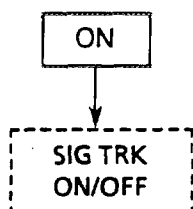

Use this softkey to turn signal track mode ON or OFF.

NOTE

Even smooth slopes can be tracked accurately by modifying the ΔX and ΔY settings, as explained in paragraph 5.3.2, Peak Search.

(4) Measuring Noise/Hz

The analyzer enables you to measure the rms of the noise level normalized at the noise power bandwidth from 1 Hz to 100 MHz, using a variety of reference levels.

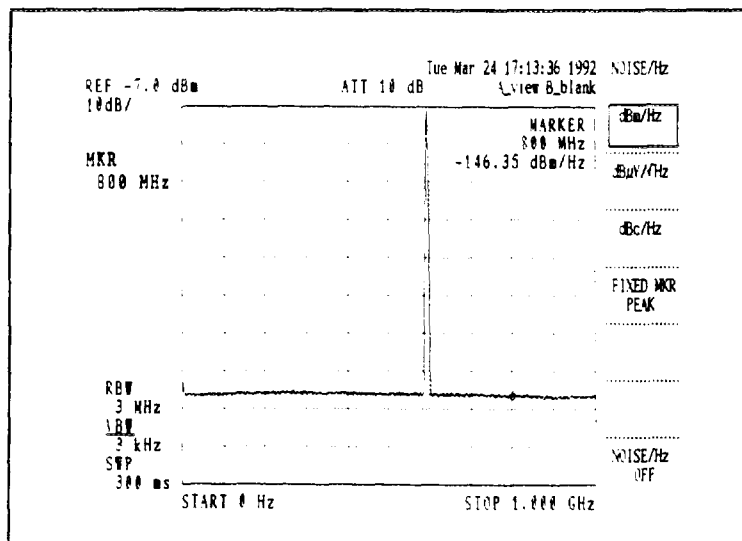
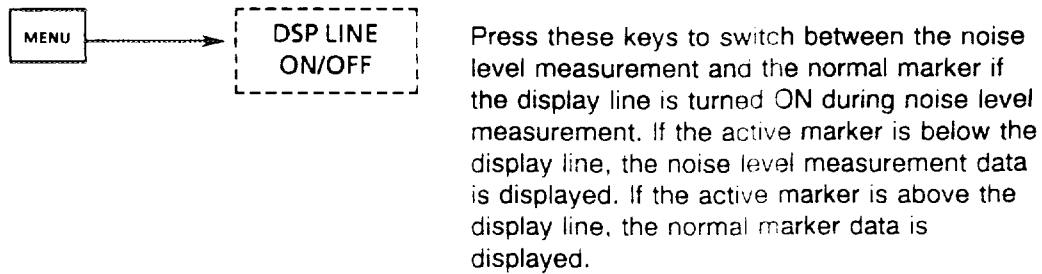
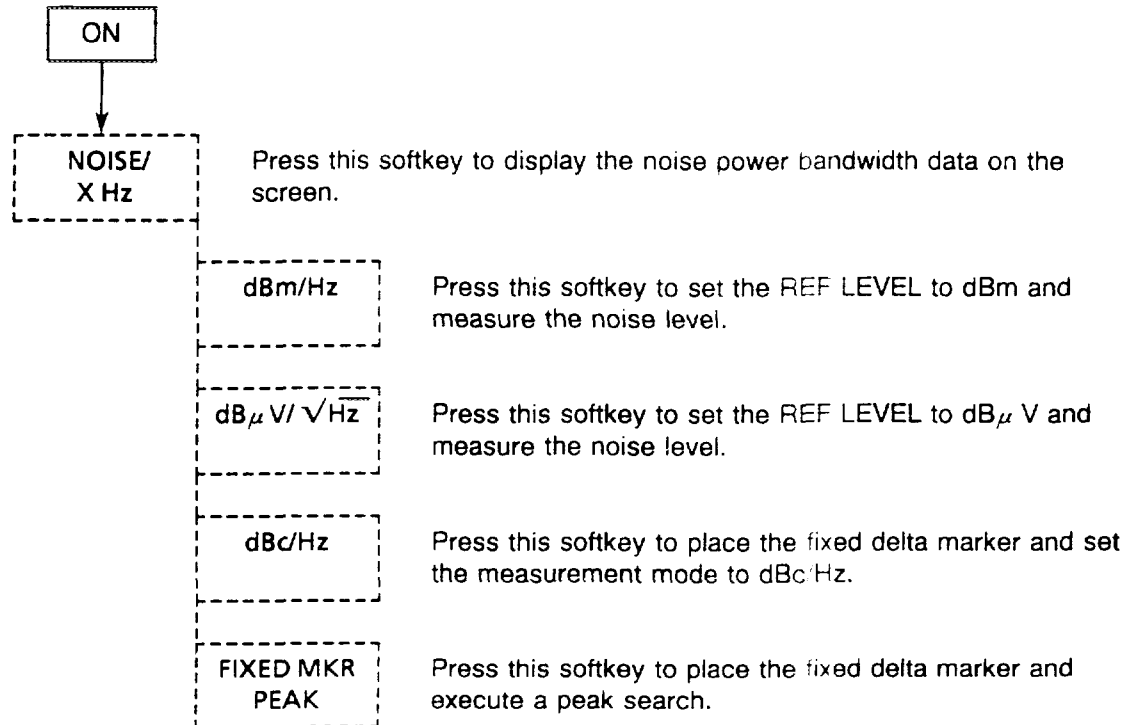

Figure 5.3-3 Noise/Hz Level Measurement



(5) Setting X dB Down

The X dB Down function lets you enter a reference point and then display the difference in the frequency and level at a specific amplitude below the reference point. The X dB value can be set within the range from 0 to the screen's dynamic range. The preset value is 3 dB.

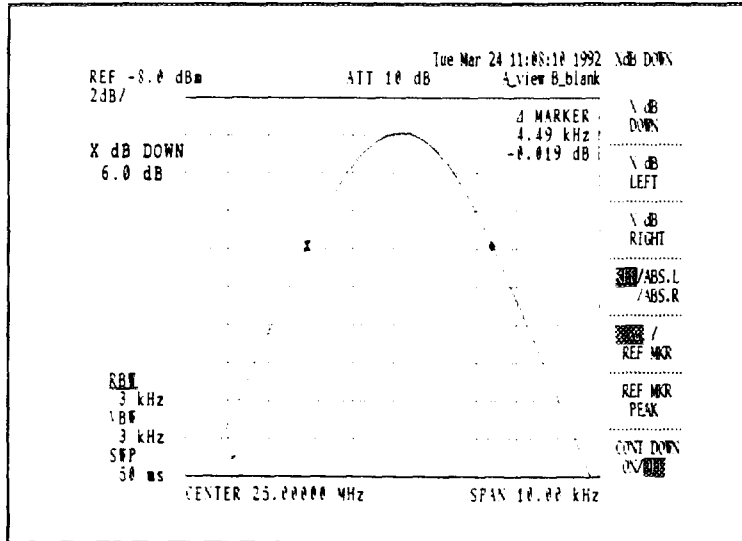
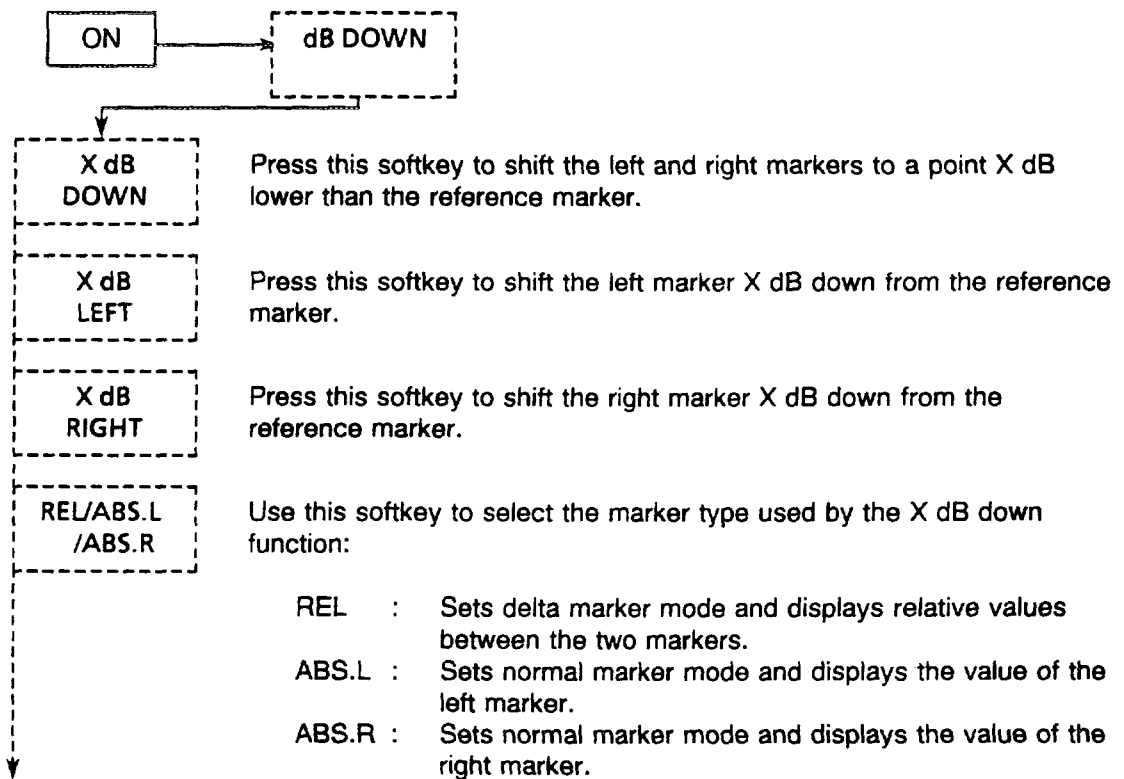
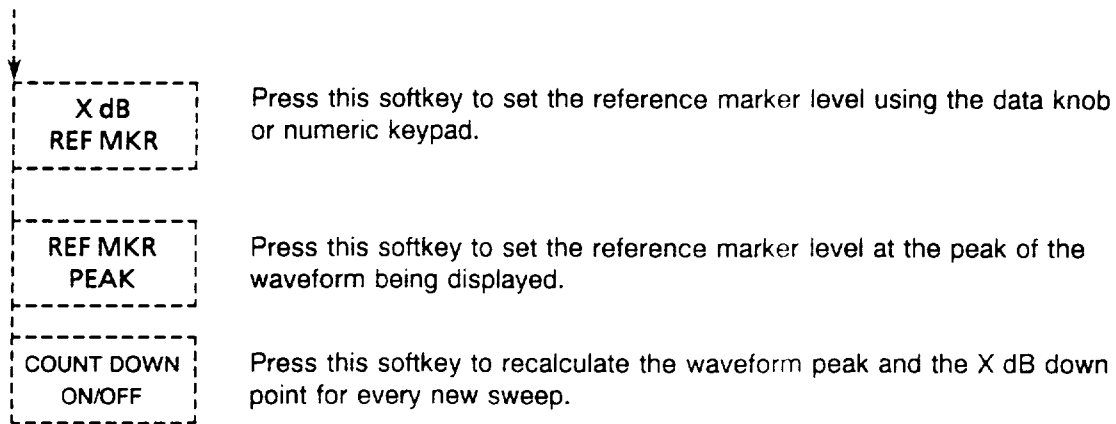

Figure 5.3-4 X dB Down





(6) Using Auto Tuning

The auto tuning feature provides a convenient way to center an input signal and set the reference level by pressing a single key. When you use auto tune, the analyzer adjusts the span within the range of about 40 MHz to 8.3 GHz for the R3265A, and about 40 MHz to 26.5 GHz for the R3271A. The analyzer then finds the input signal peak, centers the signal, sets the peak level as the reference level, and turns on the signal track function. You are then prompted to input a narrower span.

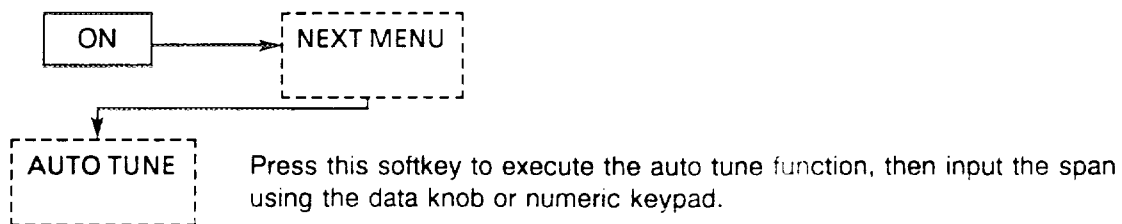

NOTE

If you press a key or softkey while AUTO TUNE is executing, the operation stops at the current span setting.

(7) Setting the Preselector

The R3265A and the R3271A use a tracking preselector to increase their dynamic range at high frequencies. In the input range from 3.5GHz to 8.3GHz for the R3265A and from 500MHz to 8.3GHz for the R3265AP from 3.5GHz to 26.5GHz for the R3271A and from 500MHz to 26.5GHz for the R3271AP, tracking must be adjusted between the preselector's sweep frequency and the input sweep frequency (the "peaking" adjustment). The auto peaking feature provides a convenient way to do this.

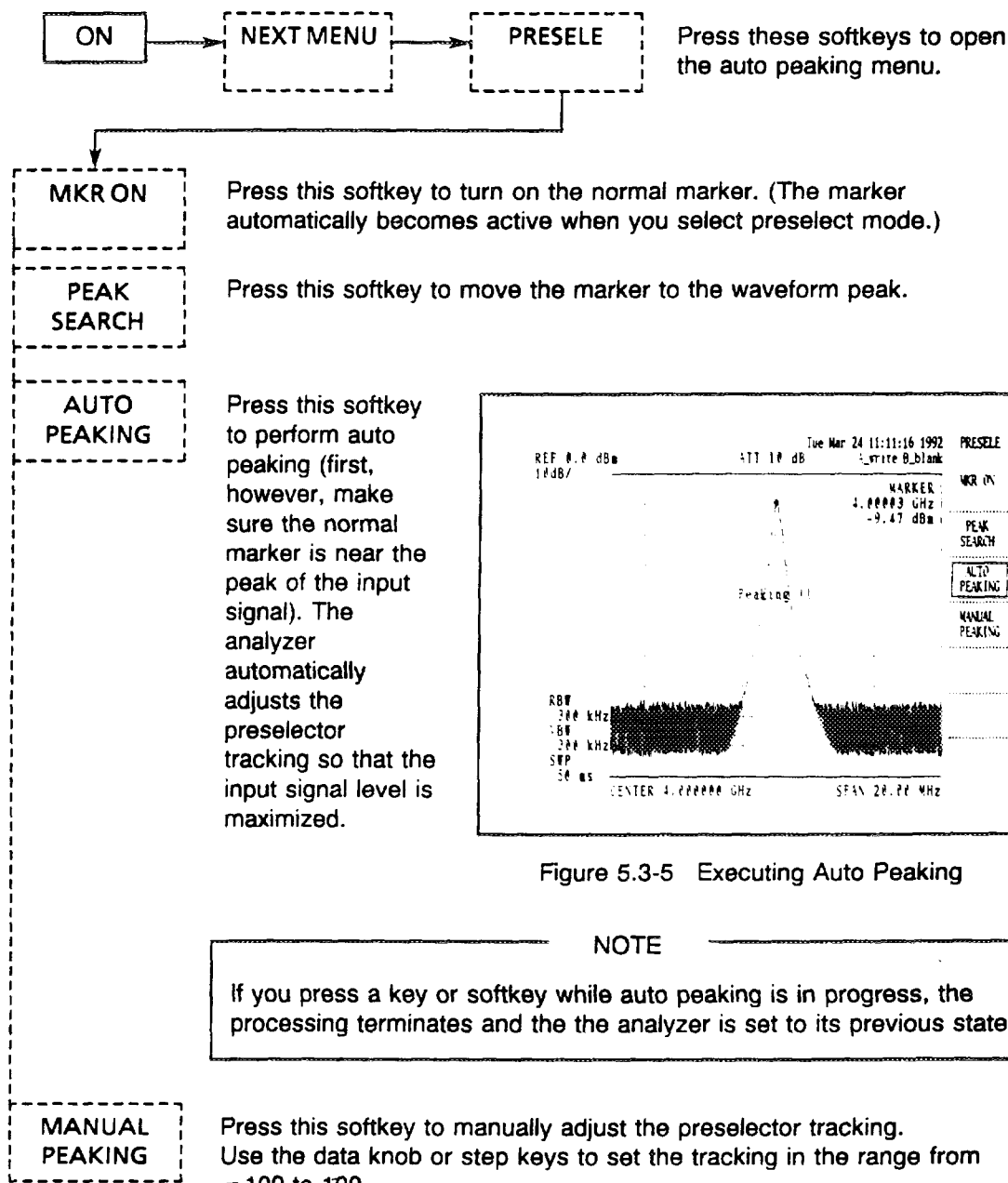

NOTE

If you press a key or softkey while auto peaking is in progress, the processing terminates and the the analyzer is set to its previous state.

(8) Selecting Relative or Absolute Marker Measurement

If the display line is on, you can display the absolute marker level or the marker level relative to the display line.

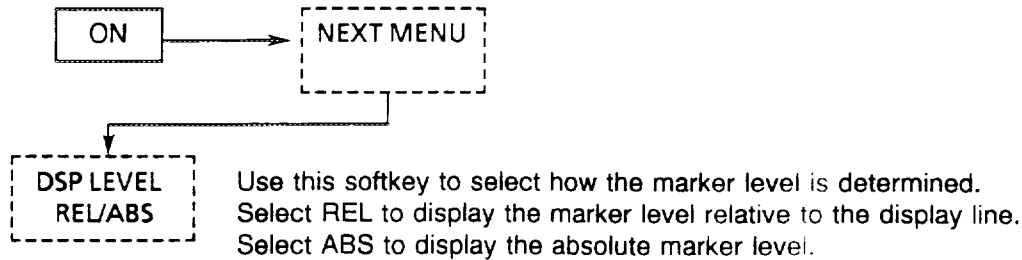

NOTE

The delta marker operates independently of this setting. The usual delta marker information appears even if the display line is turned on.

(9) Positioning the Marker Data on the Screen

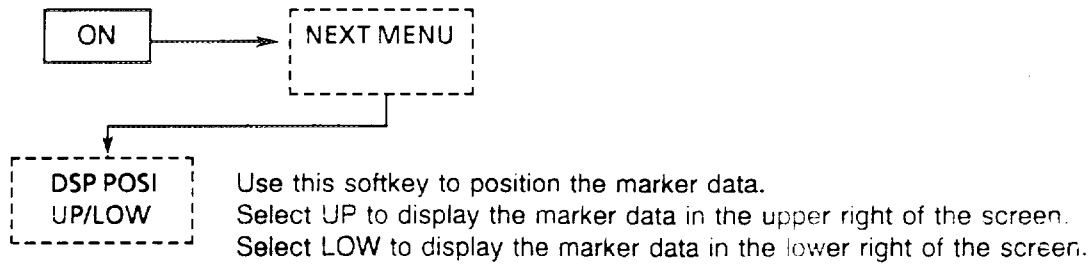

5.3.2 Peak Search

The analyzer's peak search functions include the next peak functions for placing the marker on various peaks, the ΔX and ΔY settings for defining what the analyzer considers to be a peak, and functions for listing waveform peaks in a table.



(1) Peak Search Menu

PEAK

Press this key to determine the maximum level of the waveform containing the marker. The marker is placed on the waveform's maximum level, and the frequency and the level at that point are displayed. If the measurement window is ON, the peak search is executed within the window. (See section 5.14.)

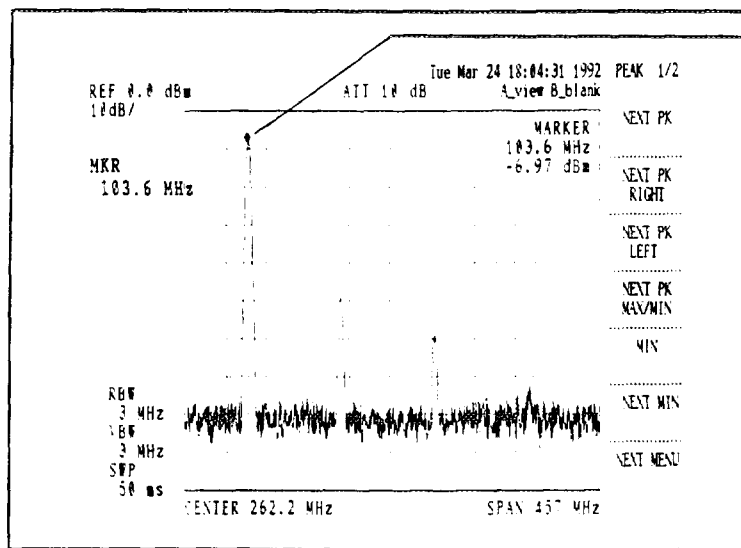
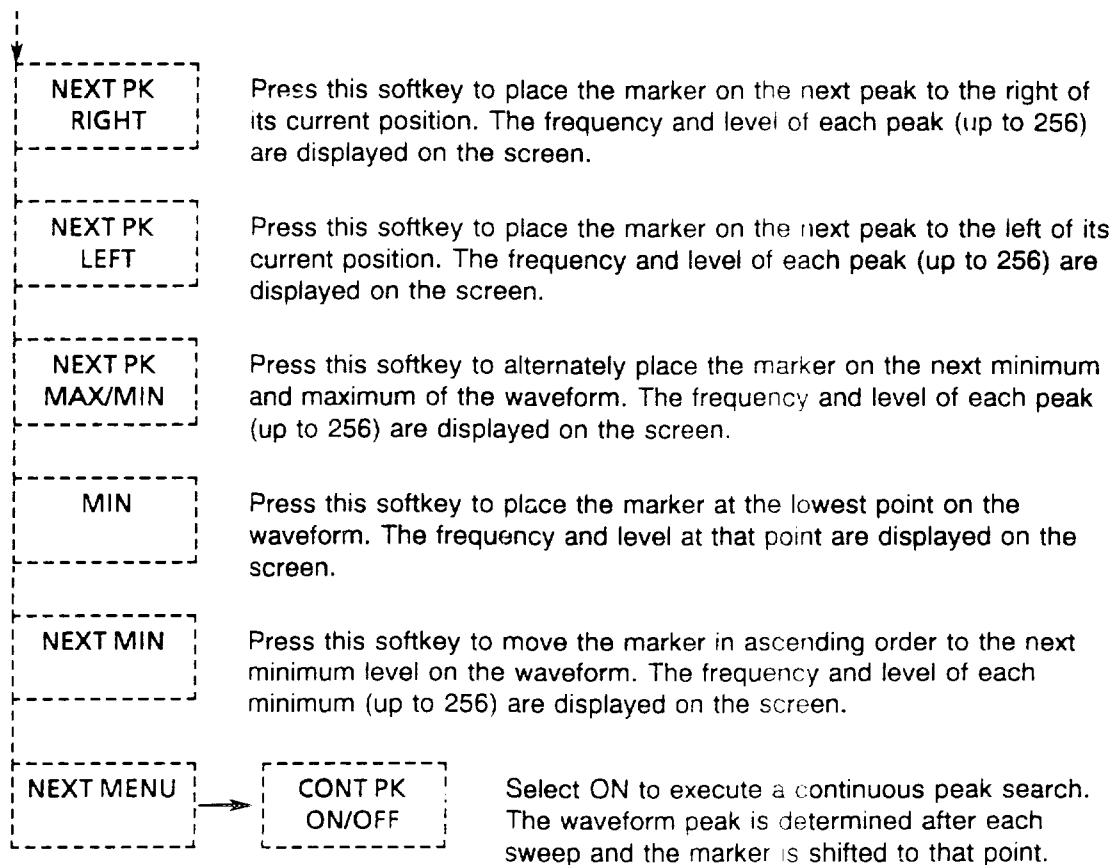

Figure 5.3-6 Peak Search Screen

NEXT PK

Press this softkey to move the marker in descending order to the next peak on the waveform. You can display up to 256 marker points and the frequency and level of each.

The next peak function only operates if the trace is in view mode or after a single sweep. If you press this softkey during a sweep, you may not get valid results.



NOTE

Be sure to save the data collected using the NEXT PEAK functions, since it's erased the next time you press PEAK or MIN search. The NEXT PEAK data is also erased if you manually adjust the marker or modify ΔX or ΔY .

(2) Setting ΔX and ΔY

If the analyzer's peak search function is not finding all the peaks you expect it to, you may need to adjust the ΔX and ΔY setting. These settings define the slope near which the analyzer expects to find a peak. ΔX and ΔY are set in pixels (display points).

When you execute a peak search, the analyzer looks at the waveform for a rising slope that is $\Delta Y/\Delta X$ pixels or greater and is accompanied by a trailing slope that is $\Delta Y/\Delta X$ pixels or greater. It then finds the maximum value between these slopes: this value is the peak. In general, decreasing ΔY for a given ΔX enables the analyzer to find peaks of less sharp spectra, and decreasing both ΔX and ΔY enables the analyzer to find the peaks of smaller spectra. Since ΔX and ΔY are based on the screen resolution, zooming in on a waveform may also improve peak searches.

Set ΔX and ΔY as follows:

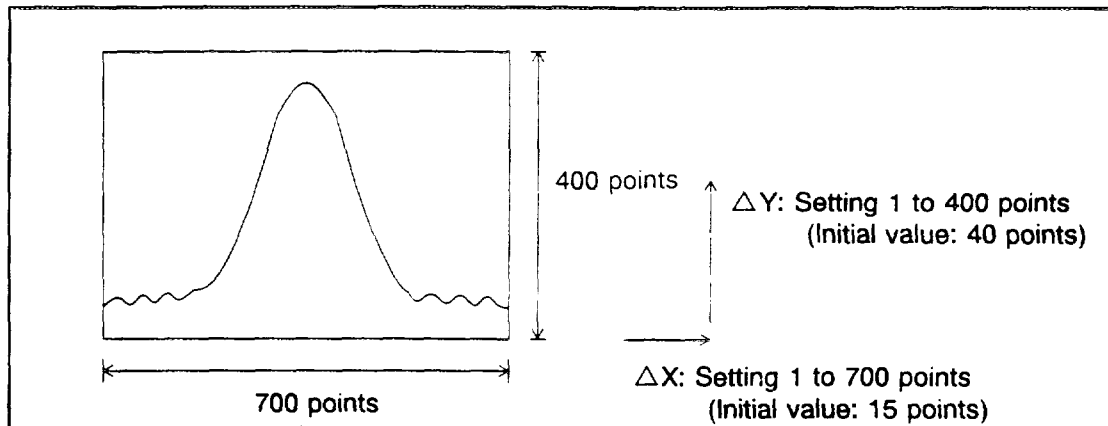
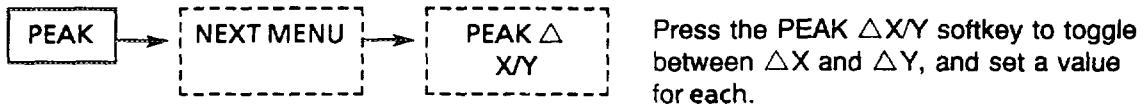

Figure 5.3-7 ΔX and ΔY Resolution

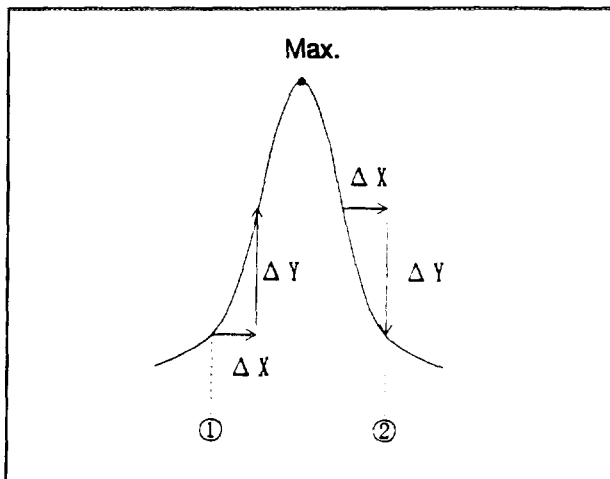
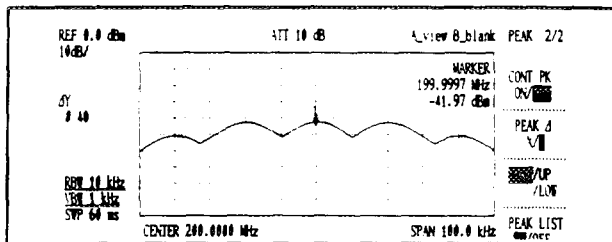

Figure 5.3-8 Setting ΔX and ΔY

The point ① where the waveform data increases by ΔY or more over the interval ΔX is defined as the rise.

The point ② where the waveform data decreases by ΔY or more over the interval ΔX is defined as the trail.

During a peak search, the analyzer searches for the maximum value between points ① and ②.



(Example 1)

If $\Delta X = 15$ and $\Delta Y = 40$, ΔY is so large that the analyzer only finds one peak.

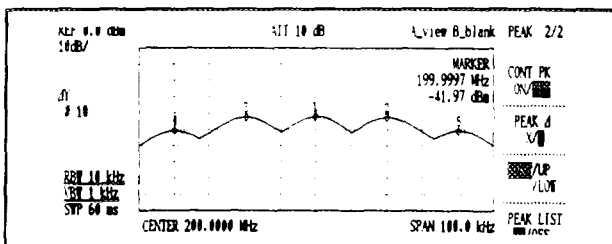

(Example 2)

If $\Delta X = 15$ and $\Delta Y = 10$, ΔY is small enough that the analyzer finds several peaks.

(3) Modifying the Peak Search Level



You can modify the peak search so that the analyzer will search for peaks above or below the display line.

Select NORM to search the entire waveform. (This is the preset setting.)

Select UP to search the level above the display line (see Figure 5.3-10).

Select LOW to search the level below the display line (see Figure 5.3-11).

Turn on the display line and adjust its level before setting UP or LOW as follows:

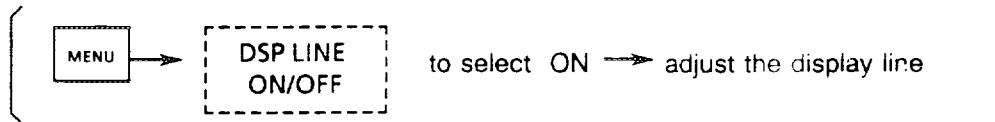

NOTE

The peak list function will not operate in PEAK search or MIN search mode.

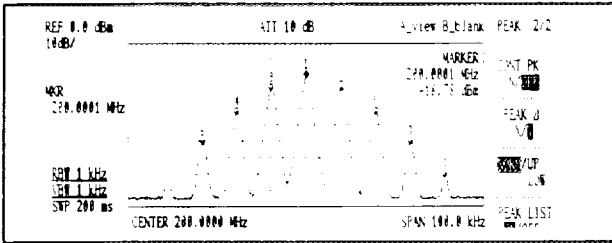
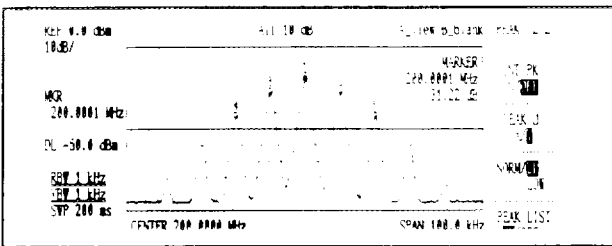
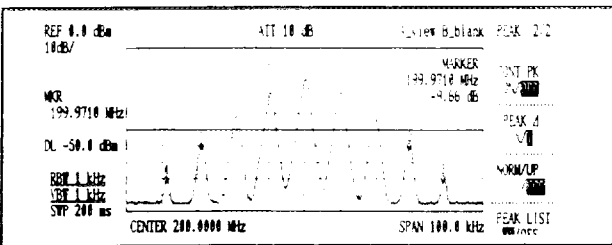

Figure 5.3-9 NEXT PK when NORM is selected



← Display line
} Not searched

Figure 5.3-10 NEXT PK when UP is selected



} Not searched
← Display line

Figure 5.3-11 NEXT PK when LOW is selected

(4) Peak List Display

This function creates a table that lists up to eight peaks in a selected order, along with their frequencies and levels. Numbered markers appear on each of the peaks.

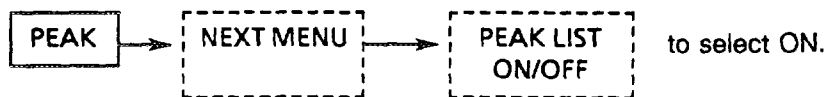

① For example, to list the eight highest peaks in ascending order (this is the preset setting), press:

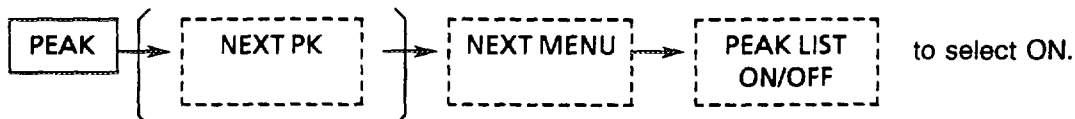

The softkey in brackets can be any of several; the options are described below.

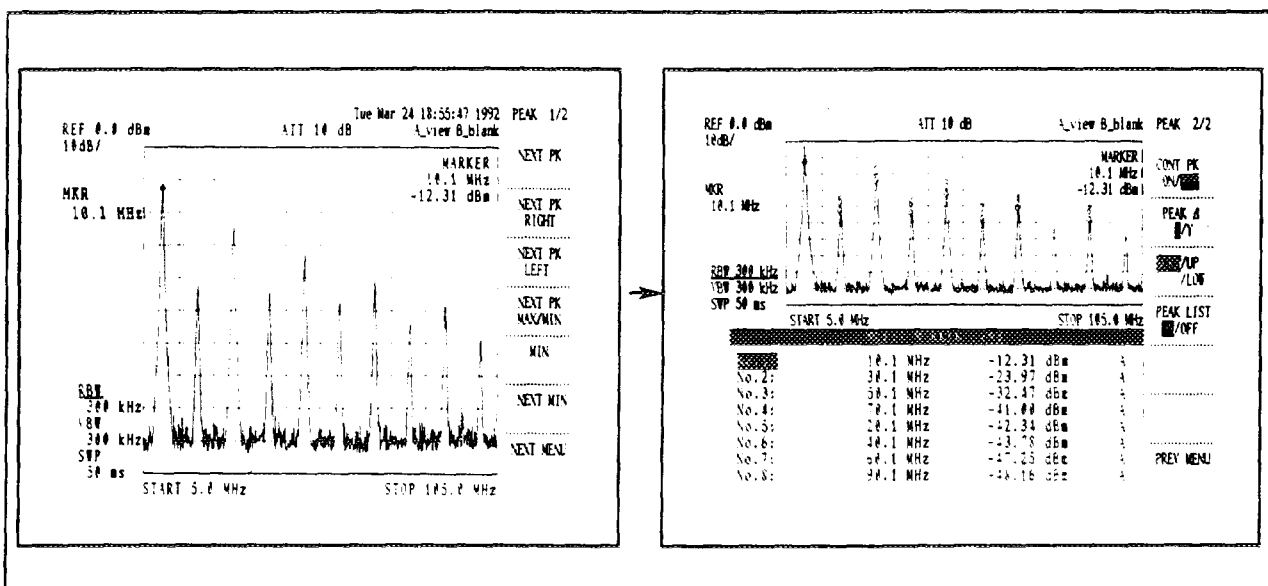
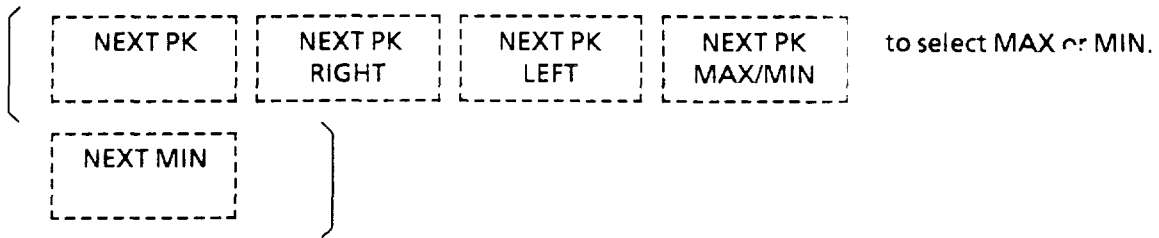

Figure 5.3-12 Listing in Ascending Order

- ② To list peaks by another criterion, press one of the following softkeys instead of the NEXT PK softkey:



For example, to list the peaks from left to right starting at the peak preceding the peak with the active marker \blacklozenge , press the following keys:

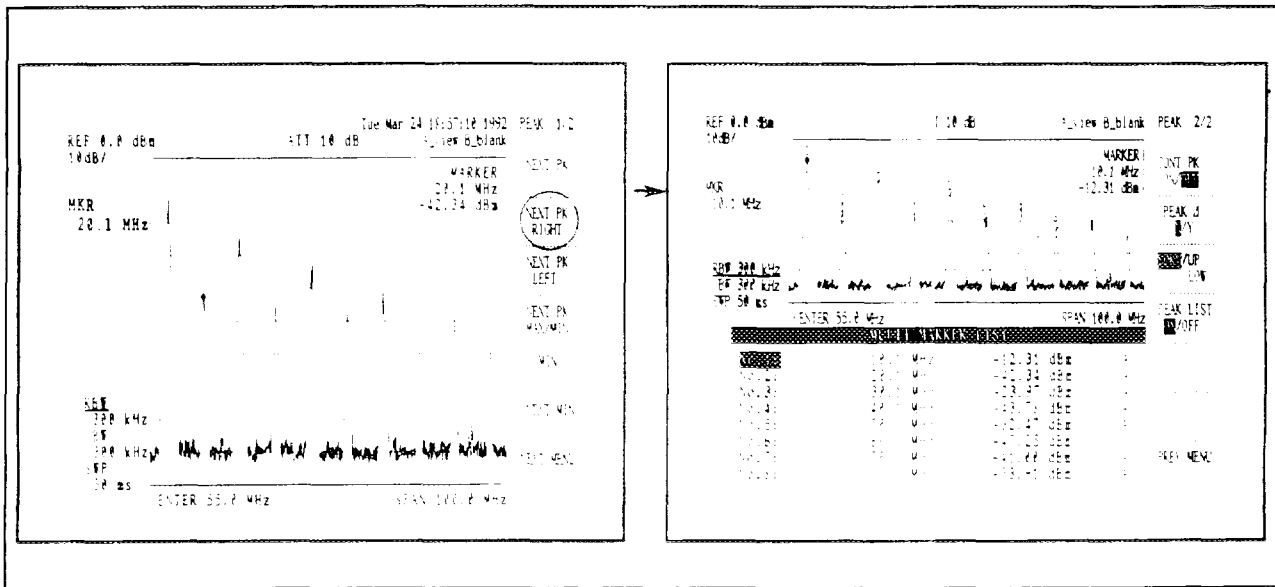
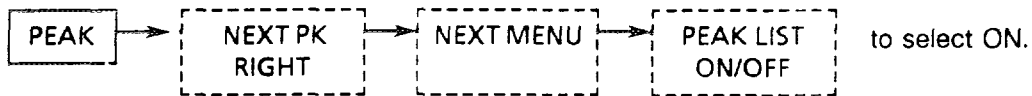
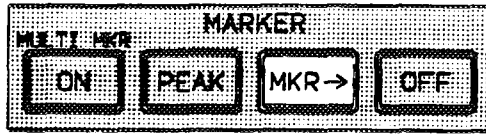

Figure 5.3-13 Listing with NEXT PK RIGHT Specified

5.3.3 Marker → (Marker to)

The marker-to function lets you use the current marker data (frequency, level, and data) as the setting for another function. For example, you can set the marker on a peak and then press MKR→CF to change the center frequency to the peak's frequency.



Press this softkey to change the center frequency to the active marker frequency.

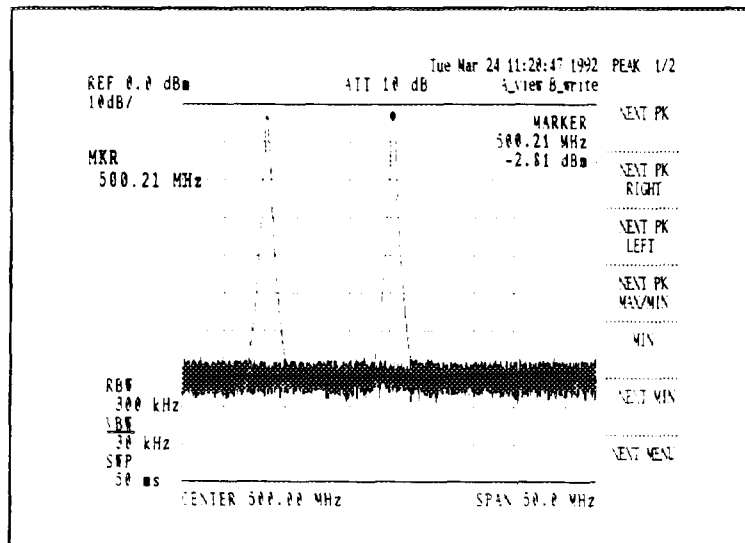
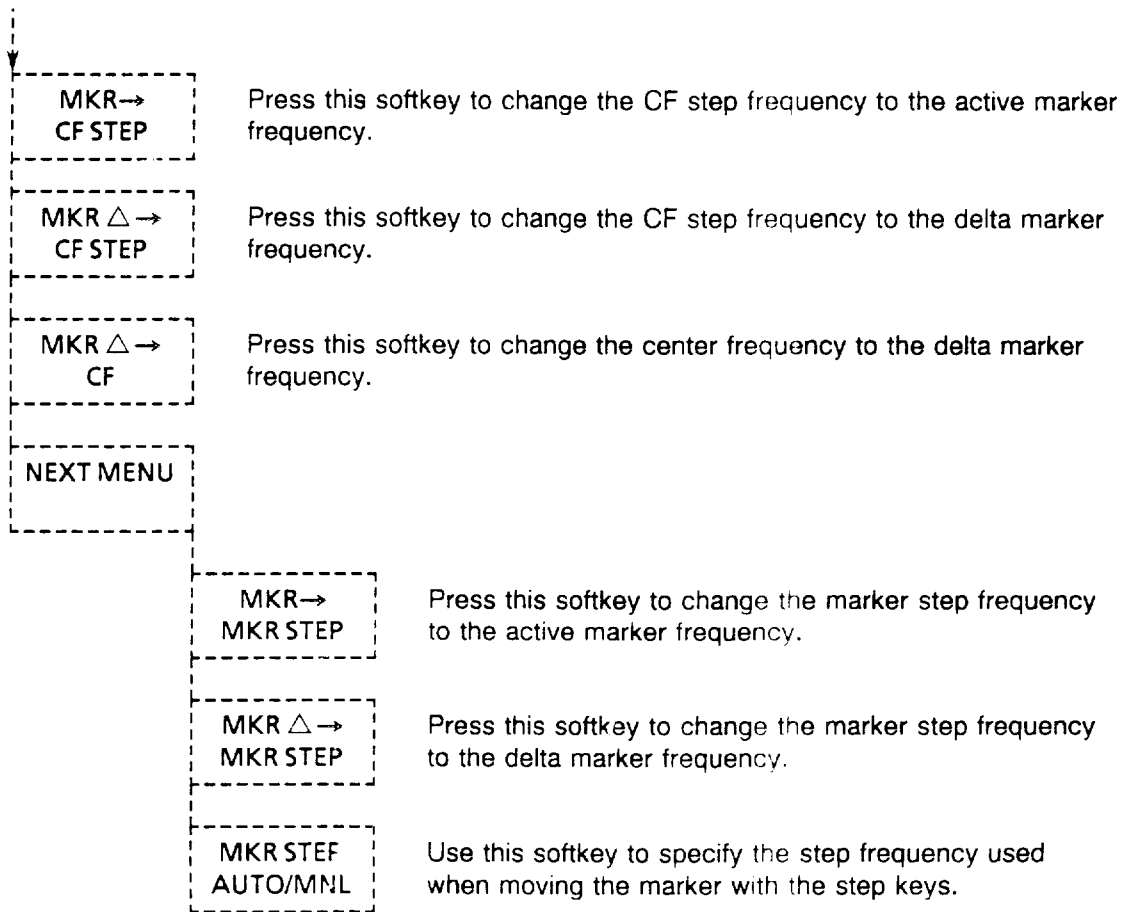

Figure 5.3-14 Setting MKR → CF

Press this softkey to change the reference level to the active marker level.

Press this softkey to change the frequency span to the delta marker frequency.



Select AUTO to set the step frequency to 1:10 of the frequency span. Select MNL to enter the step frequency size. (Enter a time value if the analyzer is in zero span mode.)

5.3.4 Marker OFF

Press OFF to remove all markers from the screen and cancel all marker-related functions, including the following:

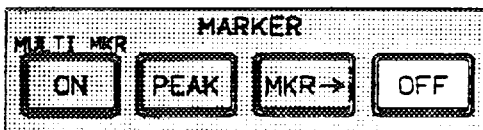

- Counter
- Noise/Hz
- Marker Pause
- Sound
- Single Track
- Manual Sweep
- AUTO TUNE
- 1/Δ Mark
- Continuous dB Down

5.3.5 Multi Marker Function

The multi marker function lets you simultaneously display up to eight markers on traces A and B, along with the frequency and level at the marker points. You can move the active marker (indicated by \blacklozenge) with the numeric keypad, the step keys, or the data knob.

You can also use the delta (\blacklozenge) marker to measure the relative distance to the multiple markers.

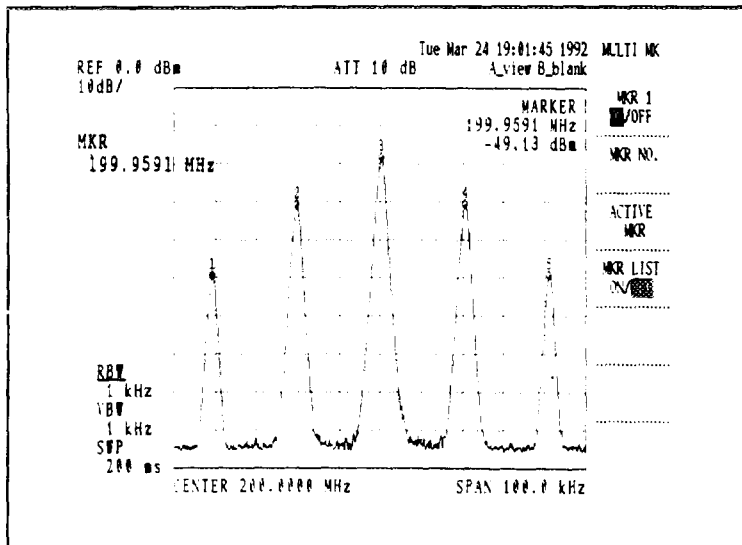

This example shows five markers on the screen. (The first marker is active.)

Figure 5.3-15 Multi Marker Display

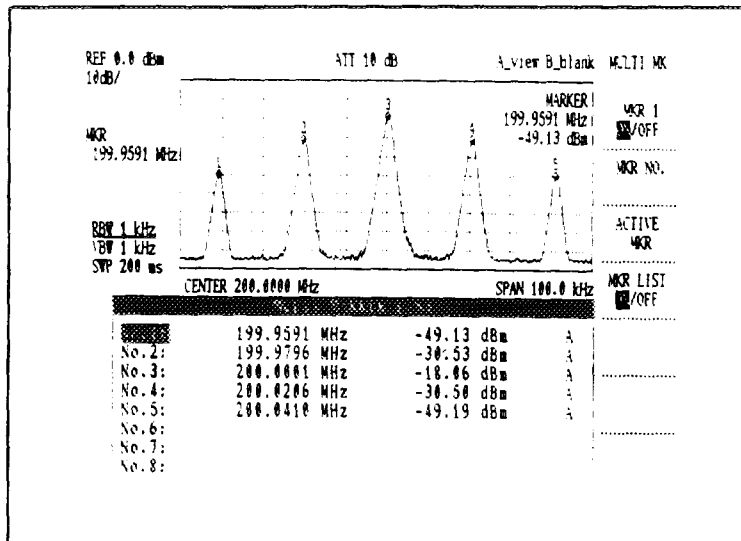

You can use the multi marker listing function to display the frequency and level data of all markers, as shown.

Figure 5.3-16 Multi Marker Listing

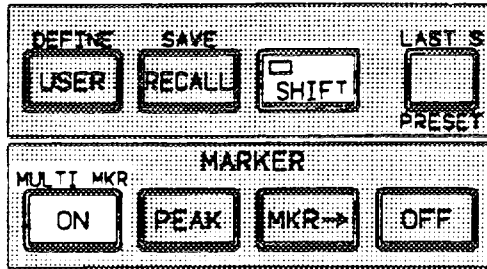

(1) Multi Marker Menu

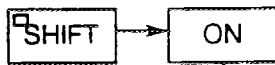

Press these keys to turn ON multi marker mode.

MKR *
ON/OFF

Use this softkey to turn a selected marker ON or OFF. (* indicates the marker number currently selected.) Use the MKR No. softkey to select a marker, then press this softkey to turn it ON or OFF.

Select ON to place the currently selected marker on the screen. It becomes the active marker when first turned ON.

Select OFF to turn off the marker.

MKR No.

Use this softkey to select from the eight multi markers. The selected marker number appears in the menu on the MKR ON/OFF softkey above.

ACTIVE
MKR

Use this softkey to select the active marker from the multi markers currently turned on. You can move the active marker (indicated by \blacklozenge) with the numeric keypad, the step keys, or the data knob.

MKR LIST
ON/OFF

Use this softkey to display a list of the marker number, frequency, level, and trace of all the markers in real time. The active marker is listed in reverse black and white.

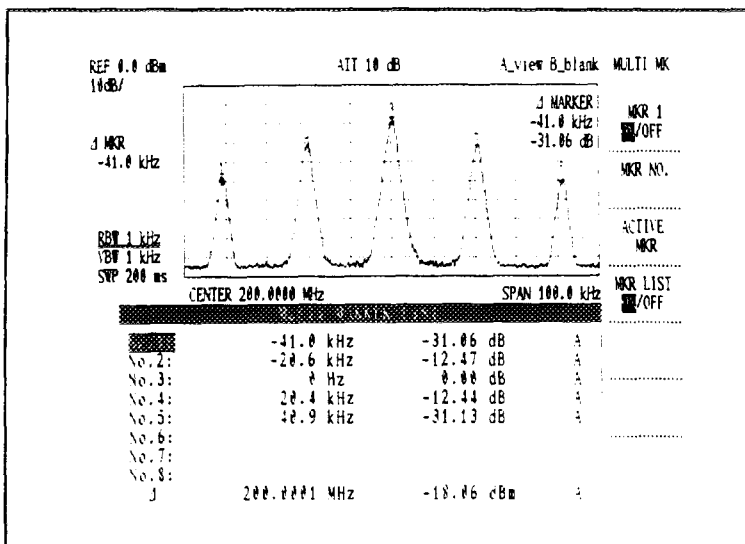

Figure 5.3-17 An Example of Delta Marker Listing

- ① This example shows a delta marker listing:
- The delta marker (X) is set on the third marker, which is active (A).
 - Relative values are measured from the delta marker.
 - The absolute value of the delta marker appears at the end of the list.

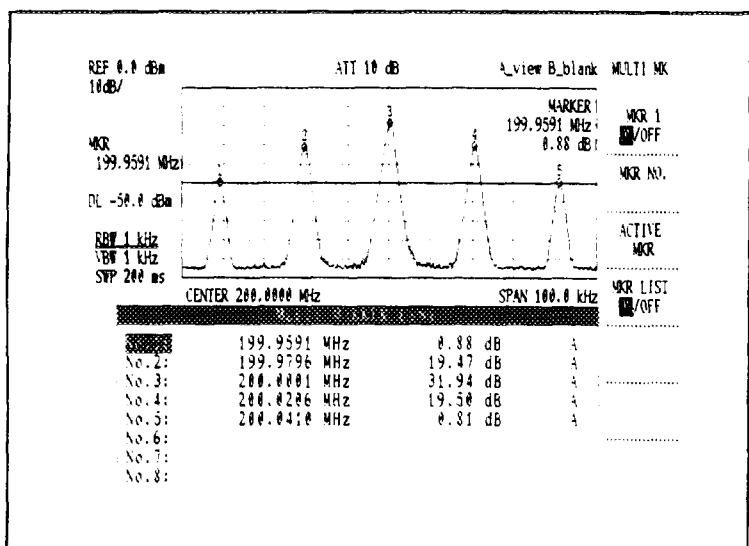
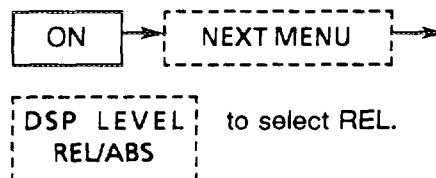

Figure 5.3-18 Example Listing with a Display Line

- ② This example shows a listing using the display line: The levels listed are measured relative to the display line. For this type of listing, be sure to set the display line to measure relative values as follows:



to select REL.

NOTE

You can't use frequency counter mode and multi marker mode at the same time.

(2) How to Use the Multi Markers

① Turning On the Multi Markers

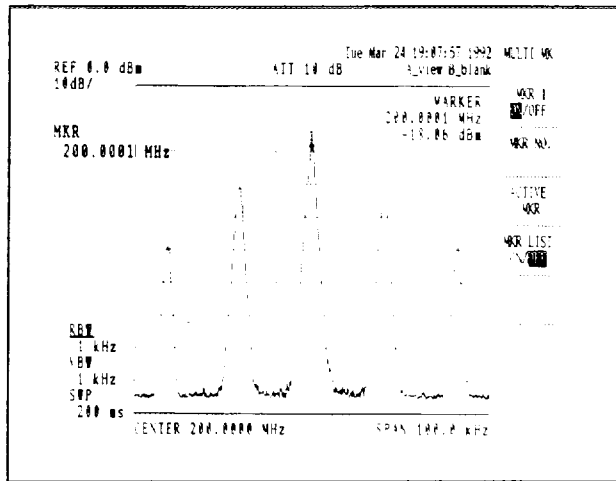

Press **SHIFT** **ON**

to turn ON marker 1.

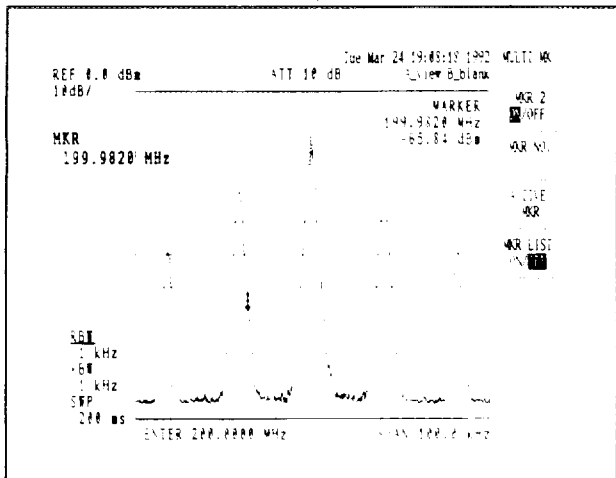

To turn ON marker 2.

press **MKR No.** to select marker

2, and press **MKR 2 ON/OFF** to select ON.

Marker 2 becomes the active marker and can be moved on the waveform.

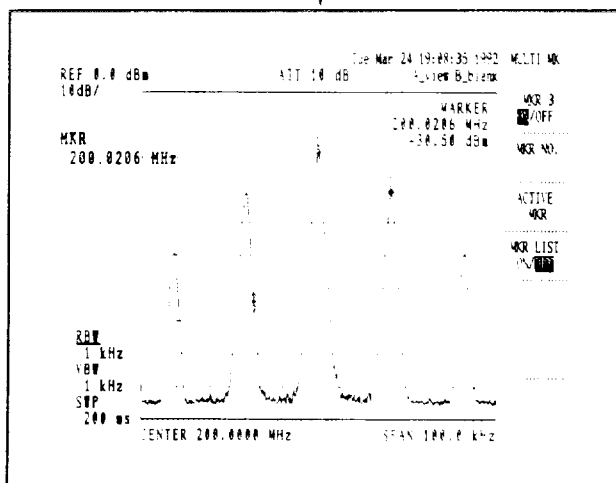

To turn ON marker 2.

press **MKR No.** to select marker

3, and press **MKR 3 ON/OFF** to select ON.

Marker 3 becomes the active marker and can be moved on the waveform.

② Turning Off the Multi Markers

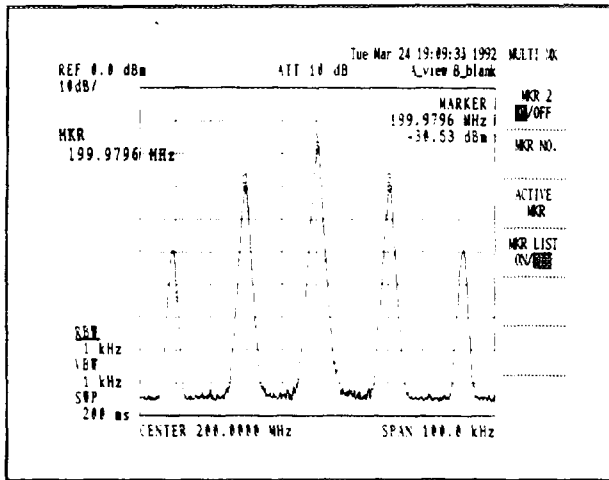

To turn OFF marker 3,
press **ACTIVE MKR** to select

marker 3 and press **MKR 3 ON/OFF**
to select OFF.

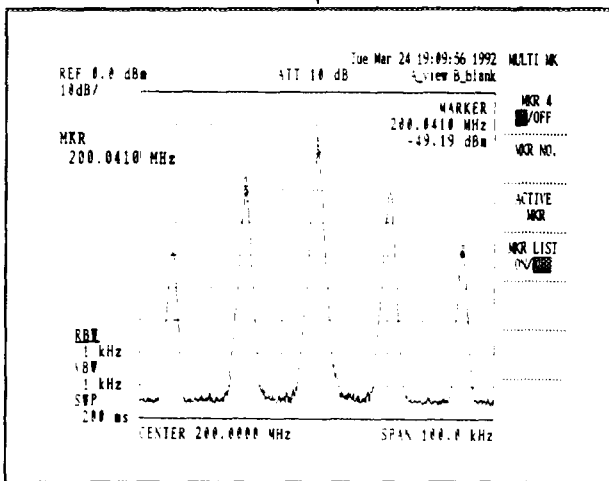

When marker 3 is turned OFF, marker
4 automatically becomes the active
marker.

If **MKR 4 ON/OFF** is turned OFF
next, marker 1 becomes the active
marker.

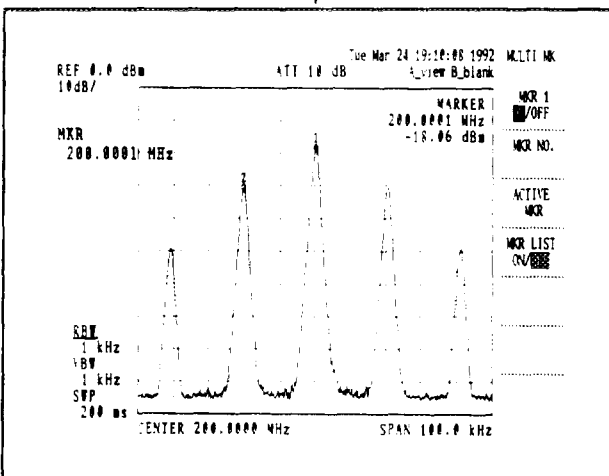

Thus, when a marker is turned OFF,
the remaining marker with the lowest
number that is larger than the marker
you turned off becomes the active
marker.

If no remaining marker has a larger
number, the marker with the smallest
number becomes active.

5.4 User-Defined Softkey Functions

Most of the analyzer's keys are software-based rather than hardware-based. This makes the analyzer a very flexible instrument. The user-defined softkeys function lets you assign the softkeys that you use most often to the user menu. Moreover, you can reassign any softkey to any softkey menu, then save your customized menus to an internal memory location or to a memory card.

Each of the analyzer's front panel keys defines a softkey group. For example, the CENTER FREQ key defines the center softkey group. Each group has seven menu spaces. The seven spaces in the user softkey group are initially not assigned any softkey members.

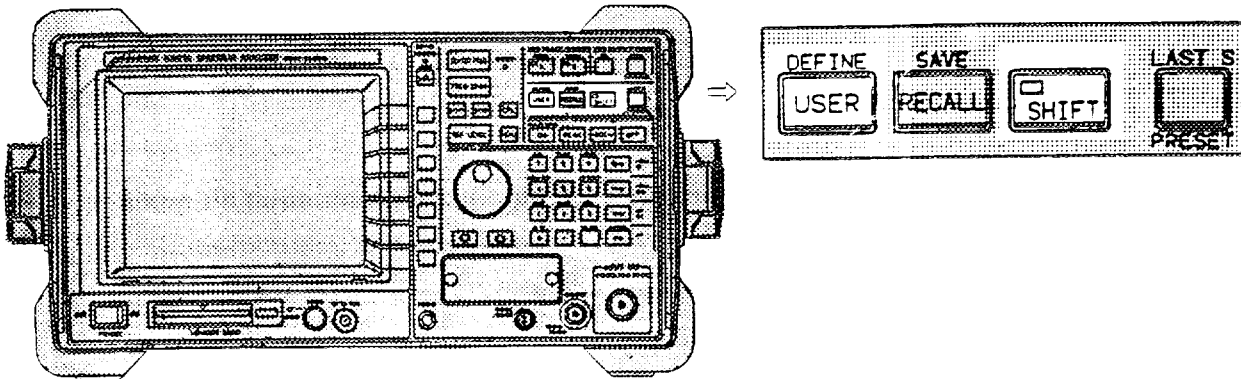

(1) Reassigning Softkeys to Menus

Press SHIFT DEFINE USER . The following display appears.

① Soft group {

② Soft member {

```

Tue Mar 24 11:23:18 1992  CHG MENU
/*** CENTER ***/
* SF1 : CF Step Size Auto/Manual
  SF2 : Frequency Offset On/Off
  SF3 :
  SF4 : Internal Mixer
  SF5 : External Mixer
  SF6 : 10 MHz Ref Int/Ext
  SF7 :
-----
/*** Center Frequency ***/
* 1 : Center Frequency
  2 : CF Step Size Auto/Manual
  3 : Frequency Offset On/Off
  4 :
  5 : Internal Mixer
  6 : External Mixer
  7 : Positive Bias
  8 : Negative Bias
  9 : Amplitude Correct
 10 : Averaging Loss Table
            
```

GROUP
ACTIVE

MEMBER
ACTIVE

ENTER

DELETE

INITIAL
GROUP

ALL
INITIAL

RETURN

Figure 5.4-1 User-Defined Display

- ① The softkey group's current menu assignments (SF1 through SF7) appear in the upper half of the screen.

These can be set by pressing the GROUP
ACTIVE and moves arrow key → to the menu you wish to alter or add by knob ○ .

- ② All softkey members appear in the lower half of the screen, sorted according to the group they initially belong to.

These can be set by pressing MEMBER
ACTIVE and selects the menu you wish to set by panel key or ↑ ↓ Keys.

(2) Explanation of the Menu

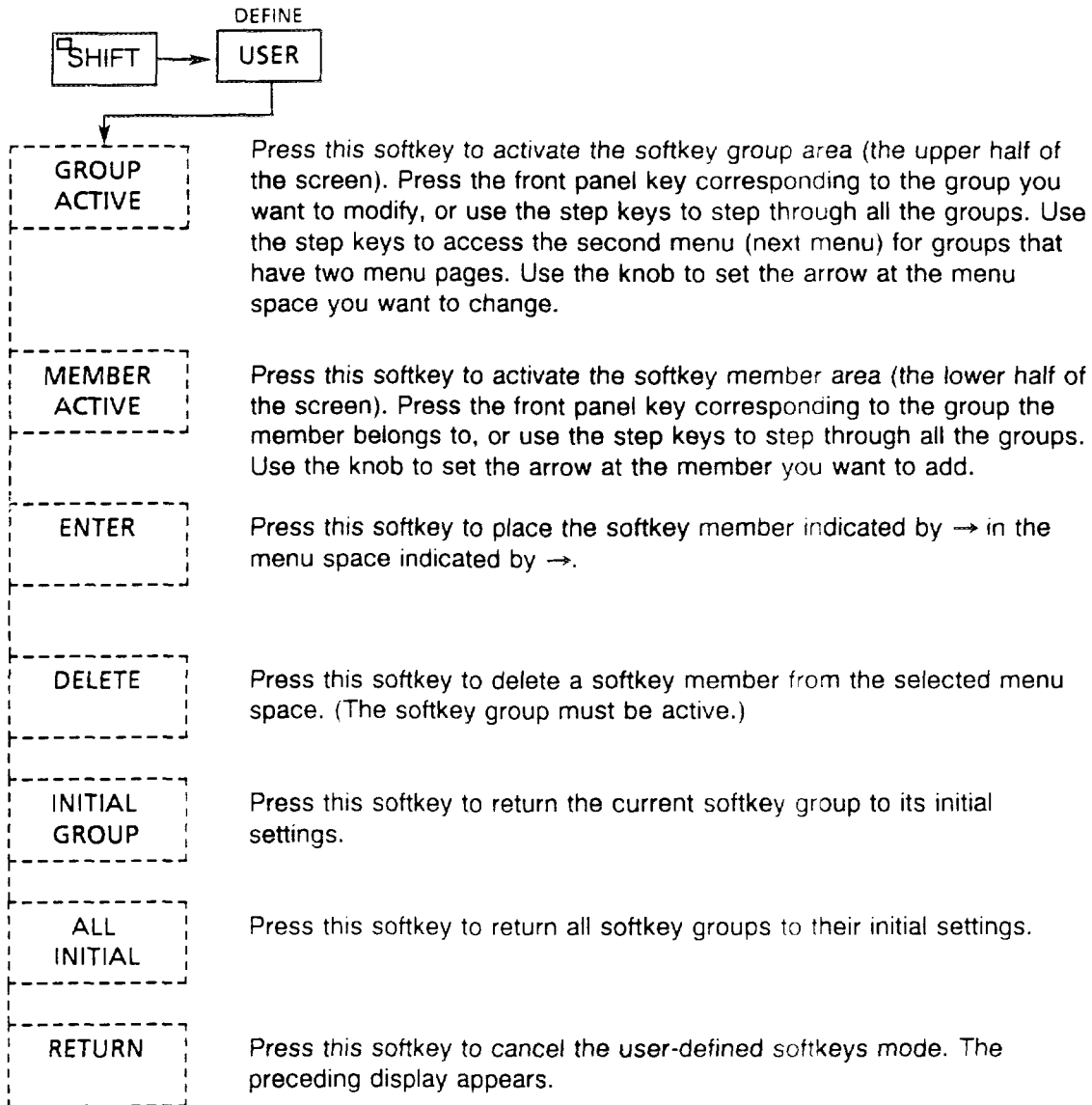

NOTE

The customized menu remains set even if power is turned off. However, before using GPIB remote control, reset all menus to their initial state. You can save customized menus on the memory card (see Section 5.5).

(3) How to Set the User-Defined Softkeys

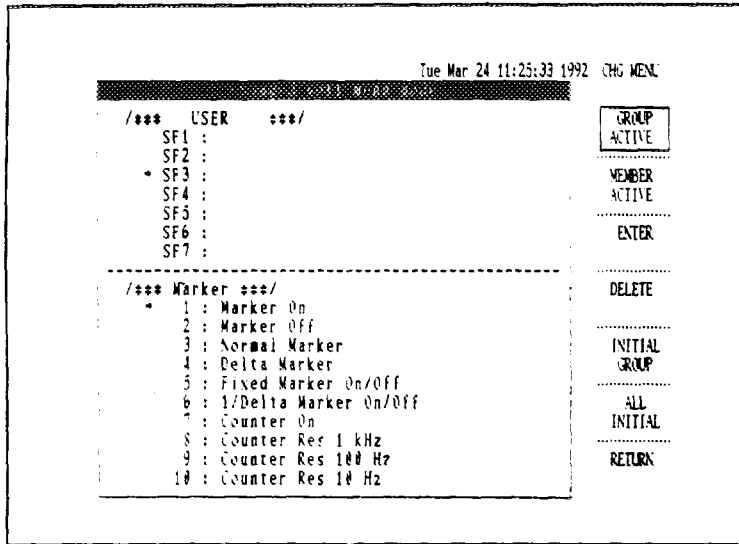

① Press **SHIFT** **USER**

GROUP ACTIVE

Then use the panel keys or step keys to select the softkey group to modify.

In the example at left, **USER** is selected.

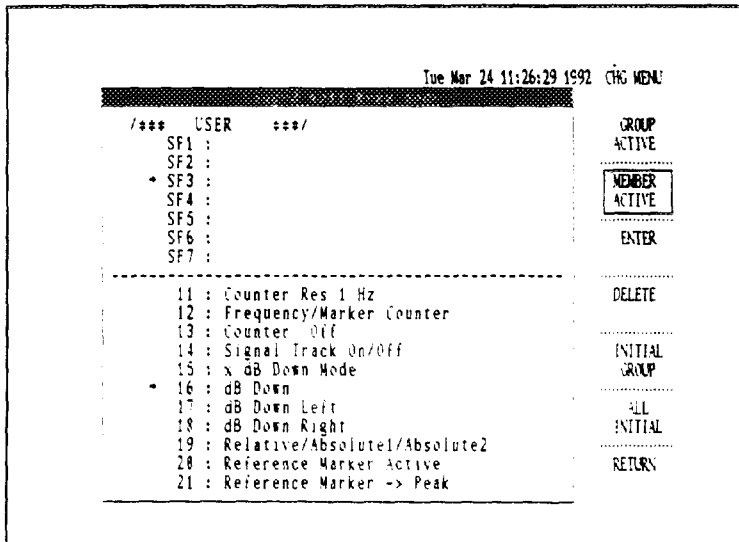

② Use the data knob to set the arrow (→) at the menu space to modify.

③ Press **MEMBER ACTIVE**

Then use the panel keys, step keys, or data knob to select the softkey member to add.

In the example at left, **ON** dB DOWN is selected.

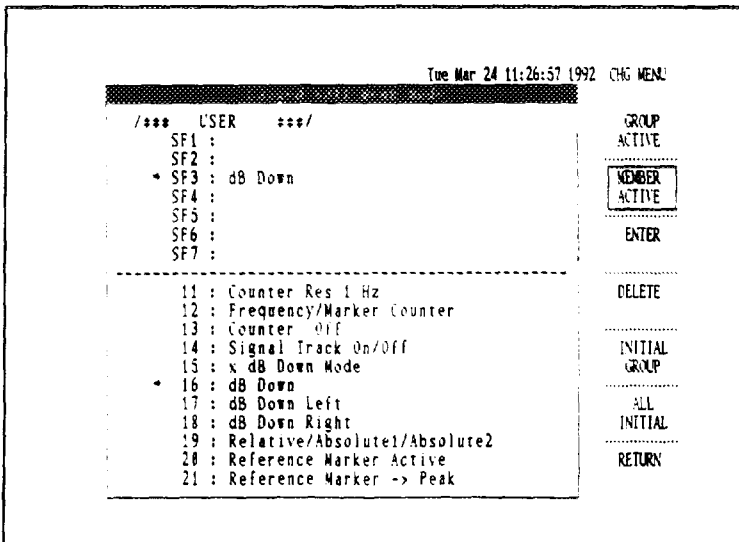

④ Press **ENTER**

to make the replacement or addition.

Note: Softkey members marked with three asterisks (***) cannot be replaced or altered.

5.5 Memory Card Functions

5.5.1 Initializing the Memory Card and Saving or Recalling Custom Menus

This section explains how to initialize the memory card and how to save or recall custom menus defined with the USER DEFINE key. Refer to Section 5.6 for more information about other uses for the memory card.

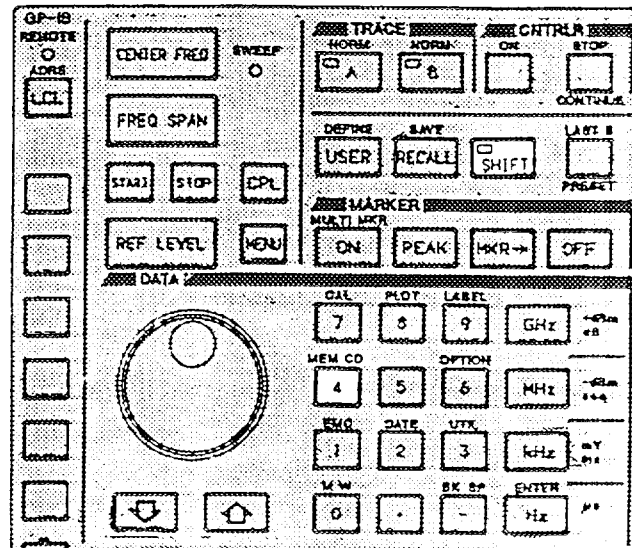

(1) External View of the Memory Card

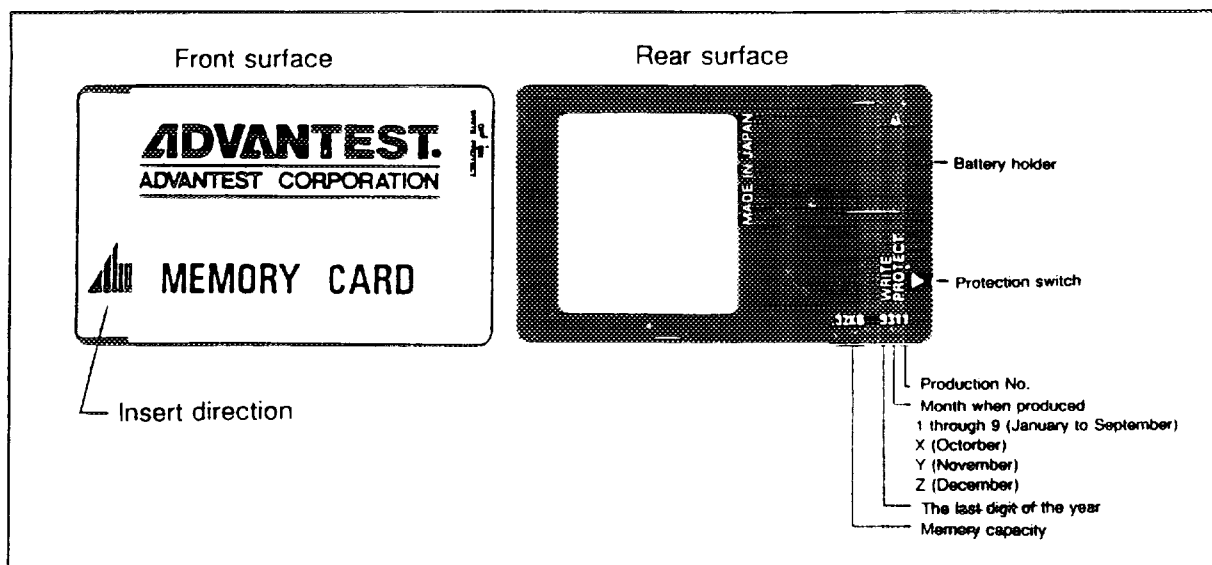

Figure 5.5-1 External View of the Memory Card

(2) Inserting and Removing the Memory Card

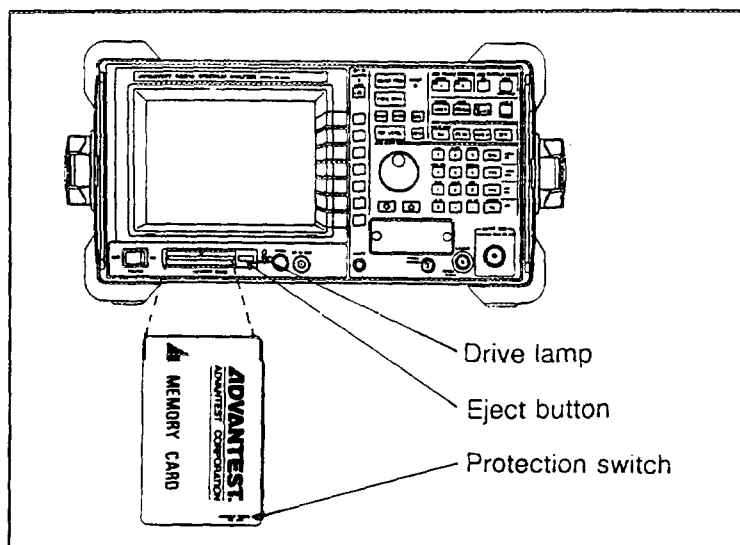

Figure 5.5-2 Inserting and Removing the Memory Card

- ① Insert the memory card with the printed surface upward.
- ② Set the protection switch to OFF to allow the analyzer to read and to write from the memory card. Set the switch to ON to prevent the analyzer from writing to the card.
- ③ To remove the card, make sure that the drive lamp is not lit, and press the eject button.

CAUTION

The drive lamp lights when the analyzer reads from or writes to the memory card. Do not remove the card or press the eject button while the lamp is lit or you may damage the card.

(3) Initializing the Memory Card

WARNING

Initializing a memory card erases any data on it.

Before you can use a memory card you must initialize it. During initialization the analyzer checks the card's memory and formatting. To initialize a memory card, do the following:

- ① Set the protection switch OFF.
- ② Insert the memory card into the analyzer.

③ Press SHIFT 4 MEM CD CARD FORMAT

The following screen appears:

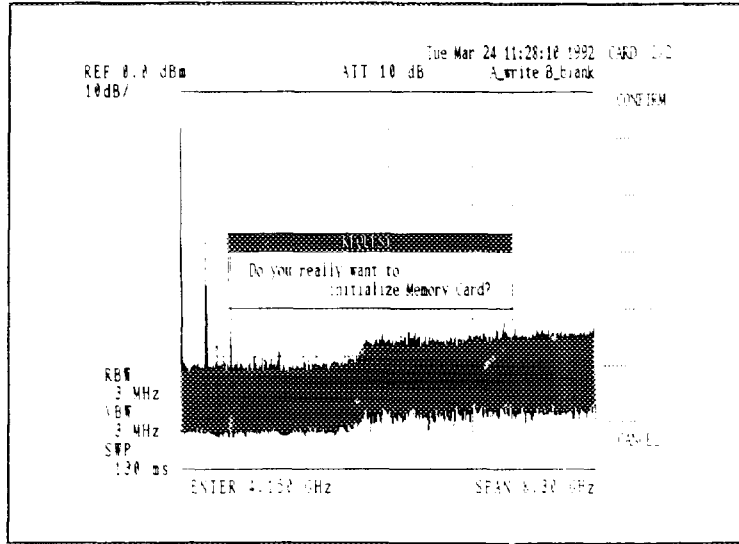

Press CONFIRM to initialize the card.

Press CANCEL to cancel the operation and return to the previous menu.

- ④ When initialization is complete, the message "Memory Card Initialized" appears as shown below. If the message "Memory Card Failure" or "Protection Switch ON" appears, make sure the protection switch is OFF and try again.

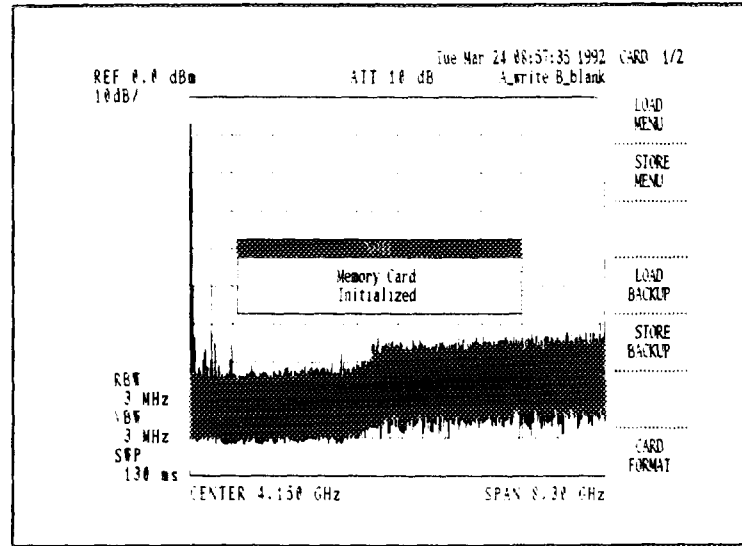

Figure 5.5-3 Initializing the Memory Card

(4) Saving a Custom Menu

The analyzer can save one user-defined menu setup per card. Do this as follows:

- ① Insert the memory card into the drive.

- ② Press SHIFT MEM CD 4 STORE MENU.

The user-defined menu setup is saved to the card. If there is not enough empty memory space on the card, however, the operation may fail. The card's memory space is divided into channels as described in section 5.6. The user-defined menu setup is stored in channel 39 on a 32Kb card, and on channel 79 on a 128Kb card.

CAUTION

1. If channel 39 on a 32Kb card or channel 79 on a 128Kb card contains data, it will be erased when the channel is overwritten. When saving soft menu data, first make sure these channels do not contain data you want to keep.
2. To protect the saved data, set the protection switch on the card to ON.

(5) Recalling a Soft Menu

To load a user-defined menu setup from a memory card to the analyzer, do the following:

- ① Insert the memory card containing the user-defined menu.

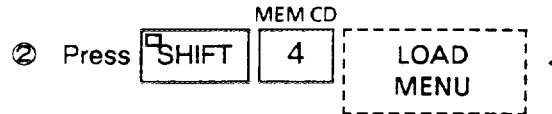

The analyzer loads the user-defined menu setup from the card.

CAUTION

The current menu setup is overwritten when a user-defined menu setup is loaded from the memory card.

5.5.2 Saving Internal Back-up Memory Data to the Memory Card

The analyzer has 17 internal memory locations (channels); these are called the back-up memory (as described in section 5.6). You can store an exact copy of this back-up memory on a 128Kb memory card.

(1) Saving Data to the Memory Card

Use this procedure when replacing the back-up memory battery, or when copying the back-up memory to other R3265A/3271A analyzers.

- ① Insert the memory card into the analyzer.

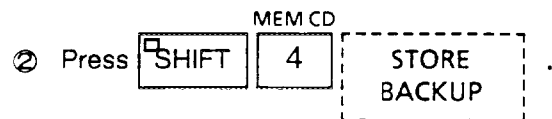

The following message appears:

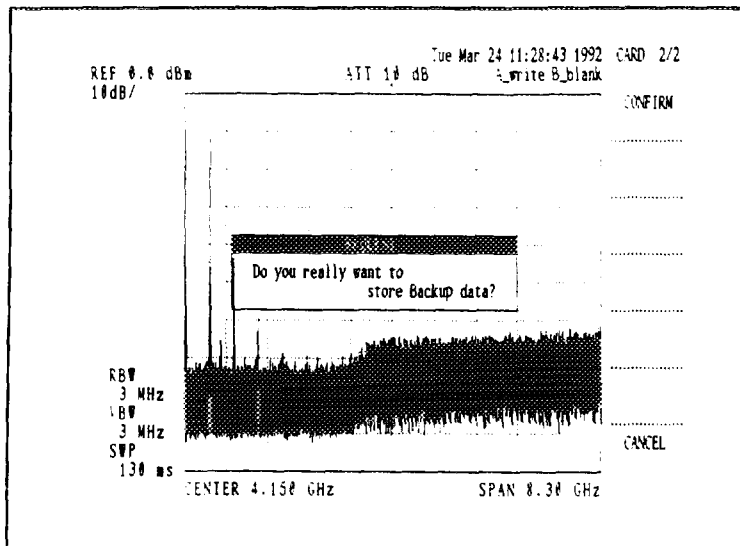

Press **CONFIRM** to store the back-up memory on the card.

Press **CANCEL** to quit and return to the preceding menu.

CAUTION

1. The memory card must have a capacity of at least 64Kb to save the back-up memory.
2. You don't need to initialize the memory card before saving back-up data, but you will need to re-initialize the card if you ever want to use it for saving other types of data.

(2) Reading Back-up Memory from a Memory Card

Once you've saved a back-up memory to a memory card, you can read it from the card to any R3265A/3271A analyzer as follows:

- ① Insert the memory card into the analyzer's drive.

② Press **SHIFT** **MEM CD** **4** **LOAD BACKUP**.

The following message appears:

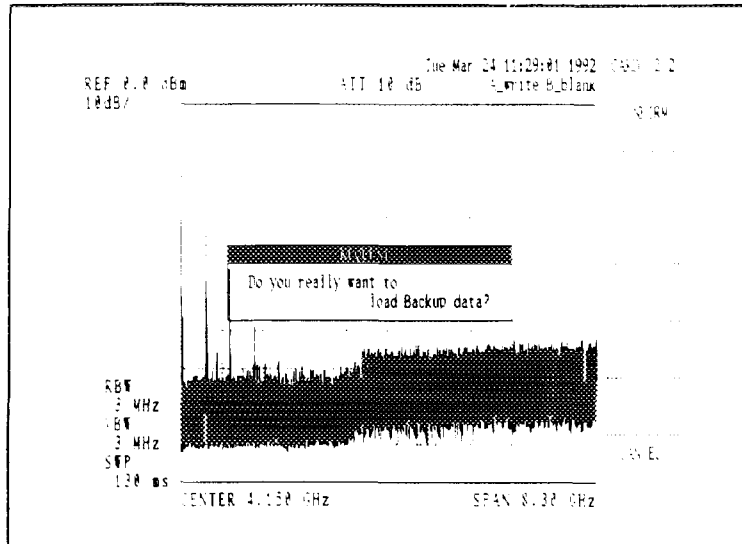

Press **CONFIRM** to read the back-up memory from the card.

Press **CANCEL** to cancel and return to the preceding menu.

5.5.3 How to Handle a Memory Card

(1) Back-up Battery Lifetime

The memory card battery will last up to five years if the card is kept in the temperature range given below.

When replacing the battery for the first time, check the number printed on the memory card rear surface (see Figure 5.5-1).

For example, if KB 9206 is printed on the memory card, that means that the battery was produced in February (month 2) of 1989 (represented by the 9). Therefore, the battery should be replaced in February of 1994.

CAUTION

The memory card operating lifetime is significantly shortened if it is kept at high temperatures.

Remove the memory card from the analyzer when not in use.

(2) How to Replace the Battery

- ① Use a Phillips screwdriver to remove both screws from the battery holder on the rear of the memory card, and remove the cover.
- ② Remove the old battery, and insert the new battery so that plus sign (+) can be seen, as shown below.

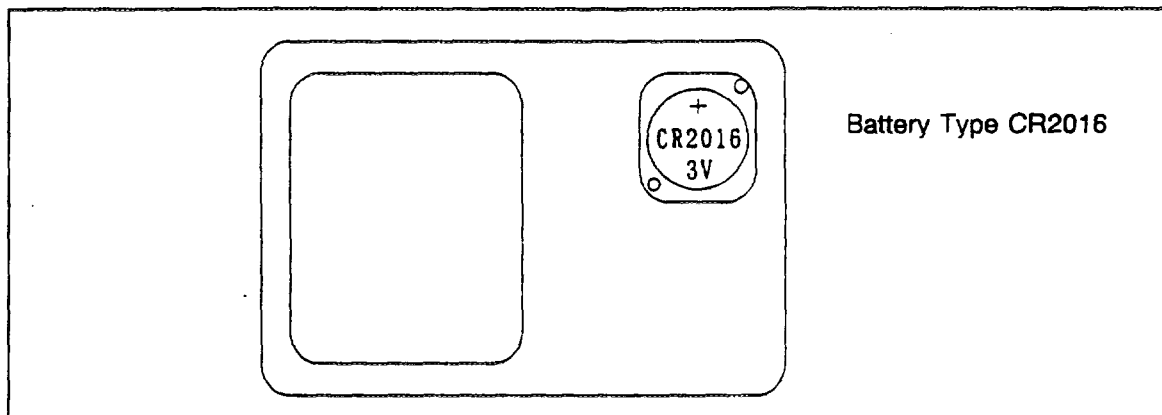

Figure 5.5-4 Memory Card Battery Replacement

- ③ Replace the cover and its attaching screws.

CAUTION

Replacing the battery erases all data in the memory card. If the card contains important data, copy the data into another memory card before you replace the battery.

Memory cards available: A09505 32Kb, SRAM card, 5 in a set
A09506 128Kb, SRAM card, 5 in a set

(3) Memory Card Handling Precautions

- ① Make sure no dust gets into the connector hole. Dust can damage the connector.
- ② Never touch the connector with a metal object. Static electricity from the metal could damage the connector.
- ③ Do not bend or drop the card.
- ④ Keep the card away from moisture.

(4) Specifications:

Memory capacity	:	32Kb
Connector	:	20-pole, 2 pcs (insertions/removals before failure: at least 5000)
Interface	:	I/O bus byte (based on the Japan Electronic Industry Promotion Association)
Memory back-up battery	:	CR2016 (1 piece, replaceable)
Battery Lifetime	:	5 years (if kept at normal temperature)
Dimensions	:	54 mm (width) × 86 mm (length) × 2.2 mm (thickness)
Environmental conditions	:	Avoid condensation Operating temperature 0° to 40° C (32° to 104° F) Storage temperature -20° to 60° C (-4° to 140° F) Relative humidity 10% to 90%
Protection switch	:	Switched ON/OFF Write inhibited when the switch is set to ON.

5.6 Save and Recall Functions

You can use the analyzer's save and recall functions to save a variety of data types, including softkey settings and waveform data. You can save this data both in the internal back-up memory or in a memory card, and then recall it when you need it.

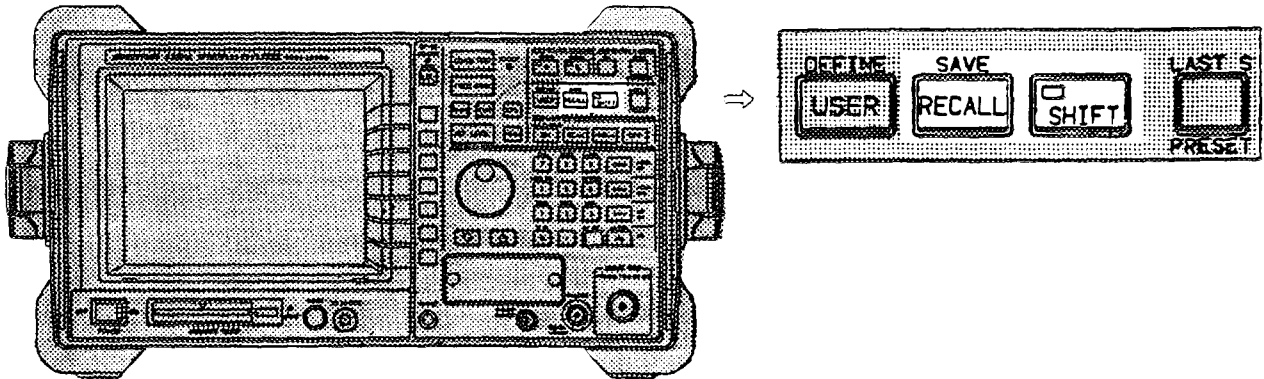

Both the back-up memory and the memory card are divided into storage locations called channels. The back-up memory has 17 channels, the first two of which are reserved for special data. The number of channels available on the memory card depends on the free space remaining. The back-up memory and the memory card can store the following data types:

- ① Back-up memory consists of channel IP and channels 0 through 15:

Channel IP	:	Contains settings used when the PRESET key is pressed to initialize the analyzer.
Channel 0	:	Contains last state settings used to restore the analyzer to its previous state after being turned off or initialized.
Channel 1 to 15	:	User-defined, and can save the following:
Setting data	:	15 items per channel
Trace A and B data	:	} 20 screens
Normalize data	:	
Antenna correction table	:	} 5 items
Limit line table 1 and 2	:	

- ② The memory card contains channels 16 and above. The maximum number of items that can be saved is determined by the memory card capacity, and can include the following:

Waveform data A/B	:	} in various combinations
Antenna correction table	:	
Normalization data	:	
Limit line table 1/2	:	
Loss table	:	
User-defined menu setup	:	1 item per memory card in a predetermined channel

A 128Kb memory card can also store a copy of the analyzer's back-up memory. (See Section 5.5.2, Saving Internal Back-up Memory Data to the Memory Card.) However, this process uses a different format than the channel storage. If you save a copy of the back-up memory, you will have to reformat the memory card to use it for channel storage again.

5.6.1 Save Function

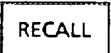
To view a list of saved data, press   .

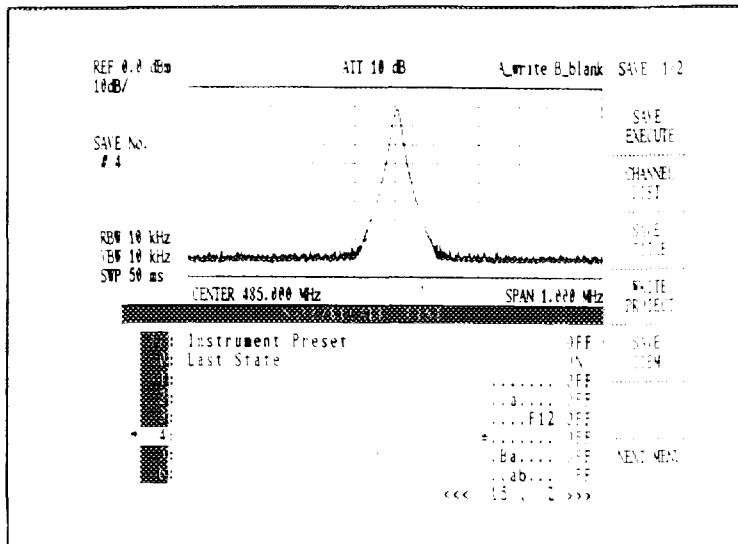

Figure 5.6-1 List of Saved Data

(1) Explanation of the list

The data list shows eight channels at a time, along with the type of data saved in each. You can scroll through the list with the data knob to view all the channels. Channels IP through 15 belong to the internal back-up memory, and channels 16 and above belong to the memory card. Placing the cursor on line 16 or above displays the memory space remaining in the memory card.

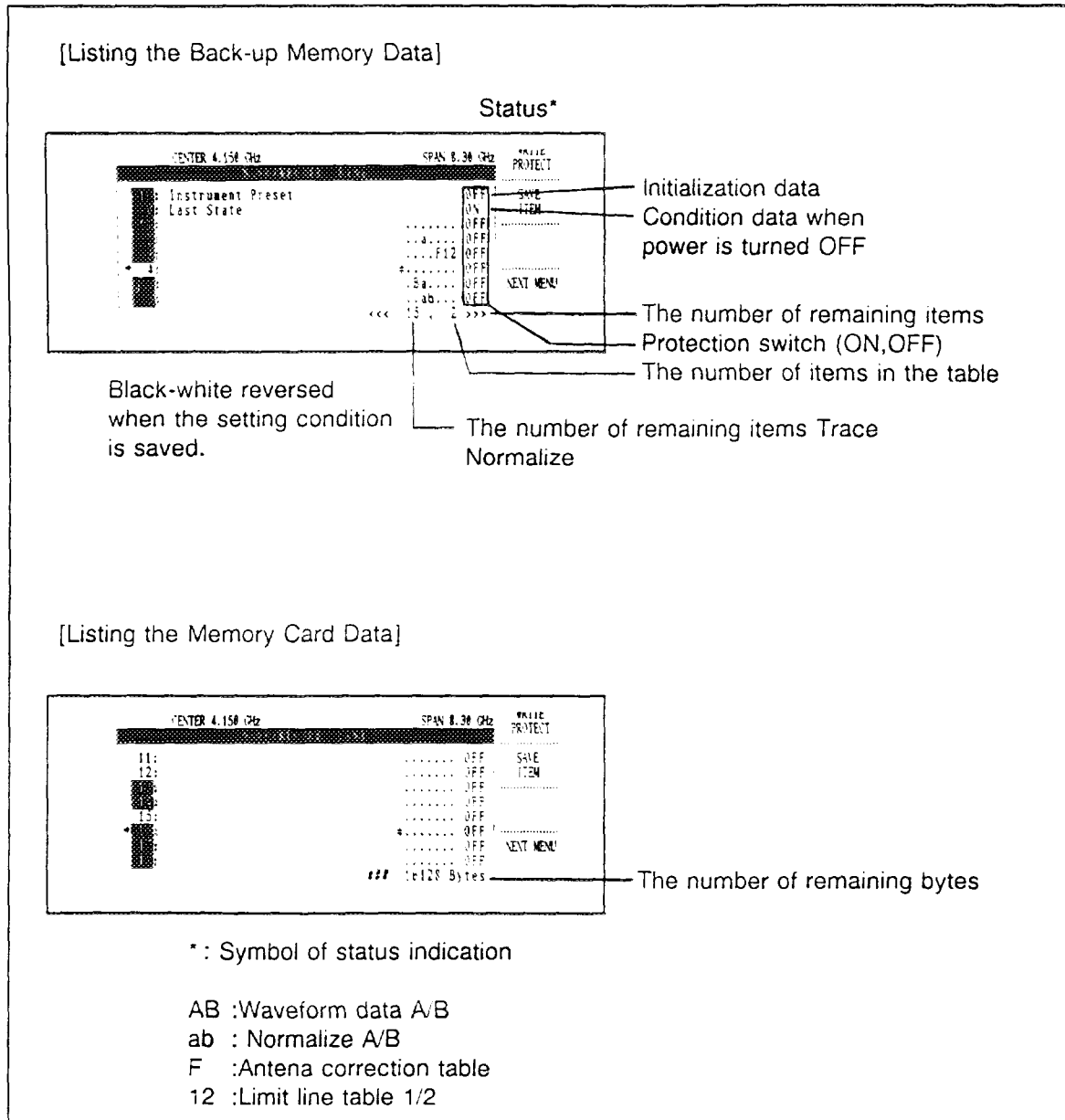
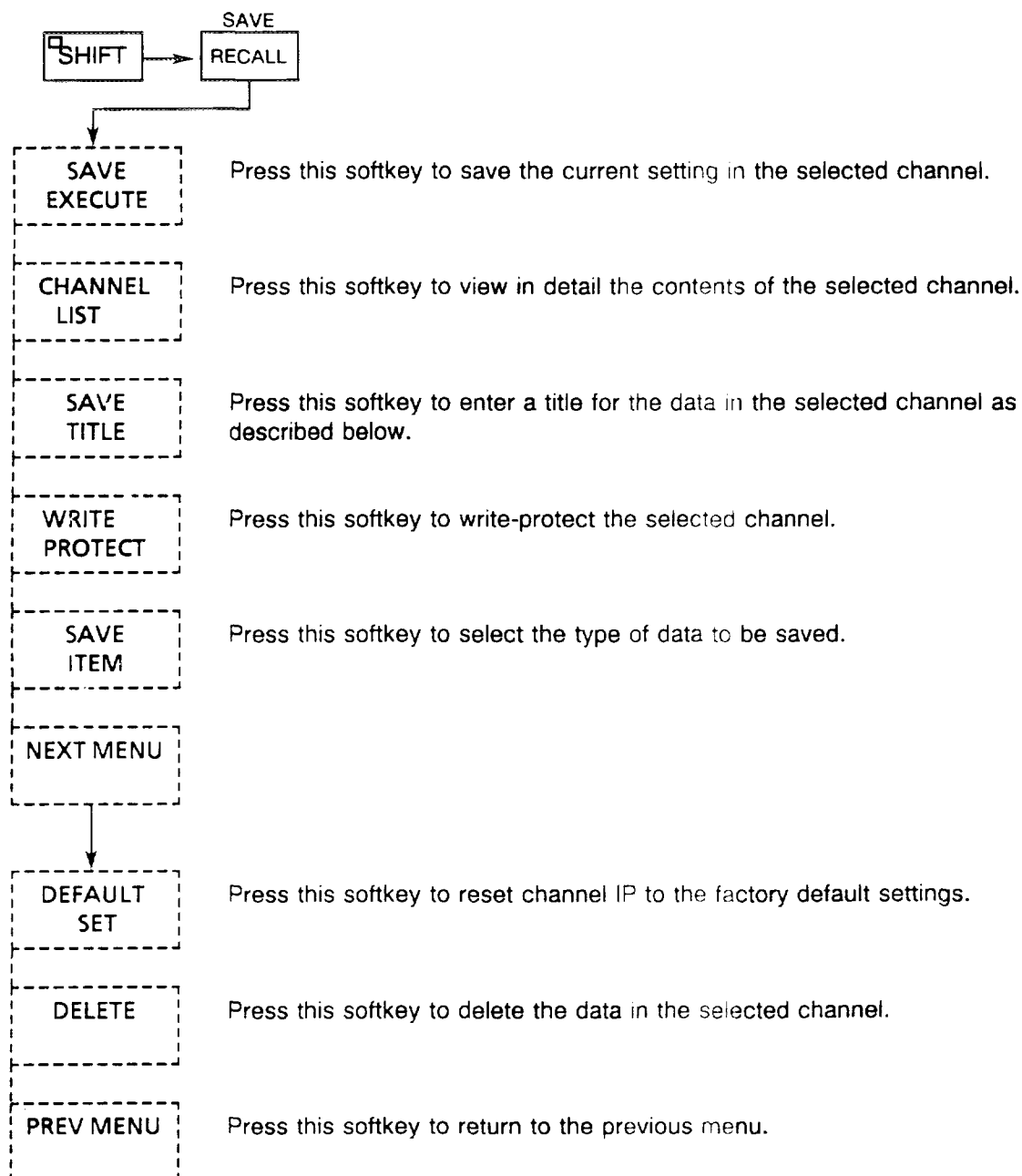

Figure 5.6-2 Explanation of the List

(2) Save Menu



Use the items in the save menu to save data to the back-up memory or to the memory card.

(3) Saving Data

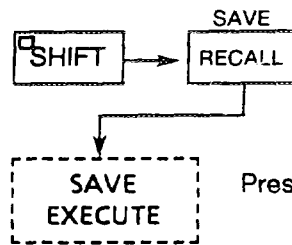

Press this softkey to save the current settings in the selected channel.

The data type selected with  is saved in the selected channel.

Settings data saved in channel IP is used when the PRESET key is pressed to initialize the analyzer.

To reset the initialization data to the factory default settings, press



You cannot save data in channel 0. This area of the back-up memory is reserved to store the LAST STATE setting when the power is turned OFF.

CAUTION

Saving data to a channel erases any data already in that channel. To protect saved data, turn on write protection for that channel.

How to Save Data

- ① To save waveform data, set the TRACE section to VIEW mode.
- ② To save normalization data, set the NORMALIZE ON/OFF key in the TRACE section to ON.
- ③ To save limit line data, antenna correction data, loss table data, or marker data, set the mode of the corresponding section ON.

- ④ To save user-defined menu data,

press  of the memory card section.

(See Section 5.5, Memory Card Function.)

(4) Viewing Data in Selected Channels

To display more detail about the data in the selected channel, press the following keys.

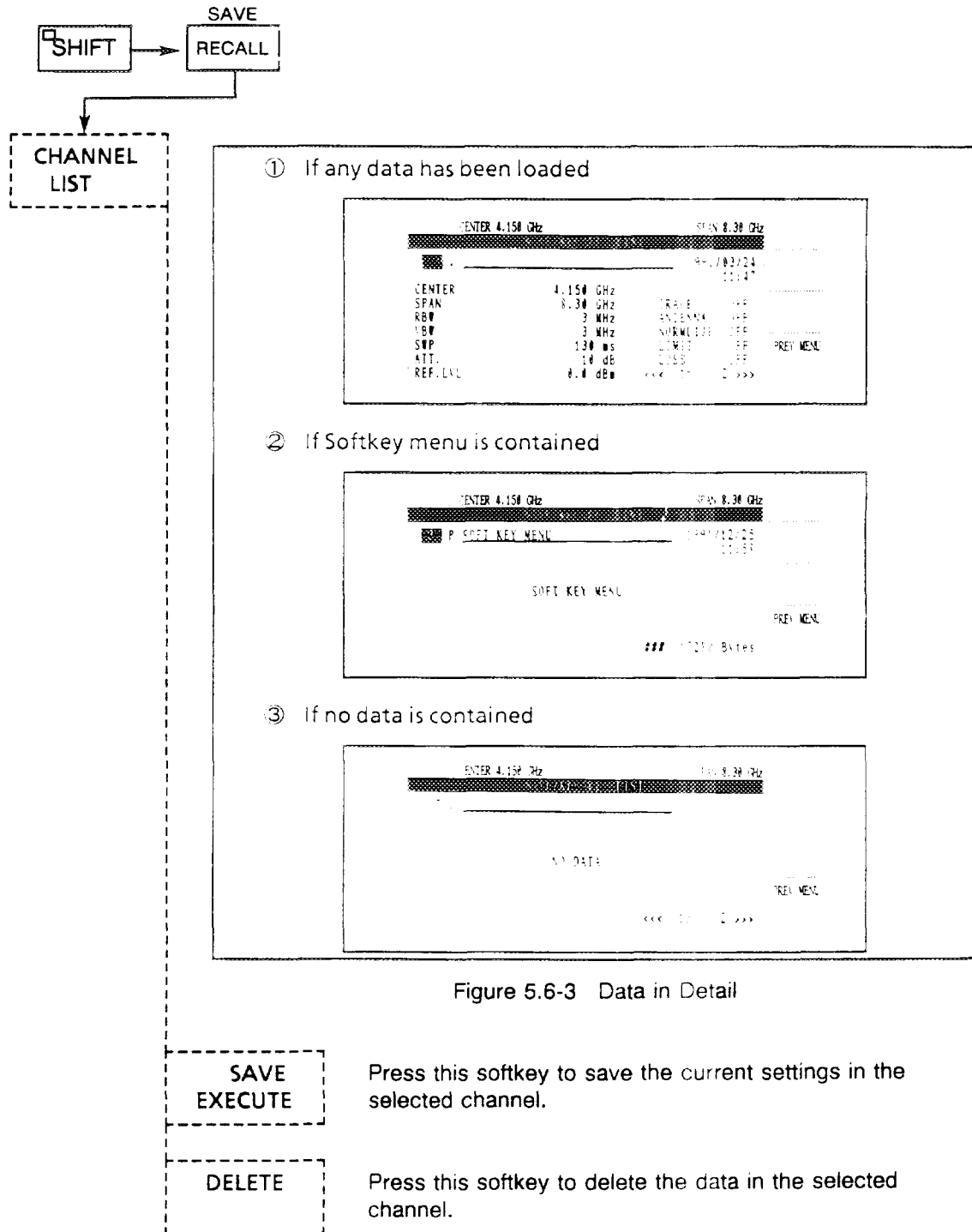
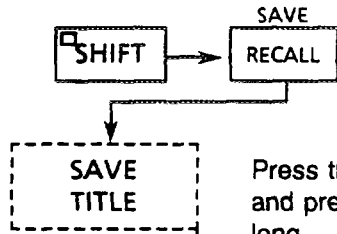

Figure 5.6-3 Data in Detail

(5) Entering the Title

The title you give to saved data appears in the save/recall list. (This is different from a trace's label, which appears on-screen.) To give a title to saved data, press the following keys:



Press this softkey to save a title. Use the knob to select a character, and press the unit key to enter it. The title can be up to 30 characters long.

After entering the title, press



When entering a title in the memory card, press

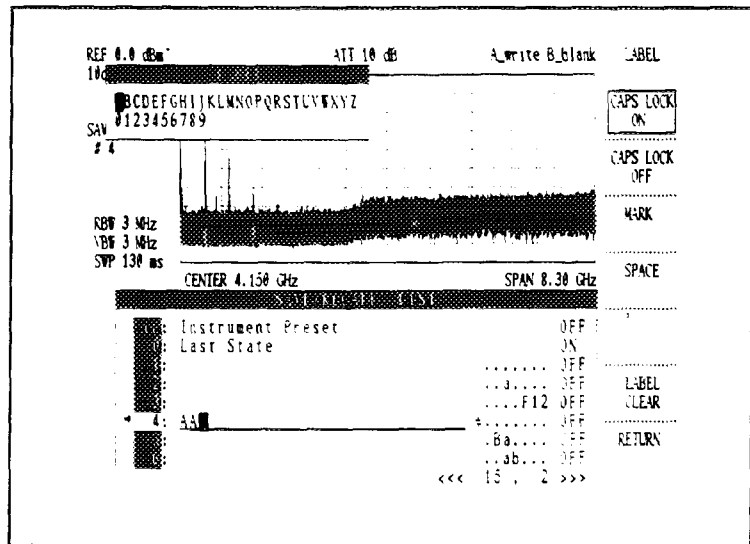
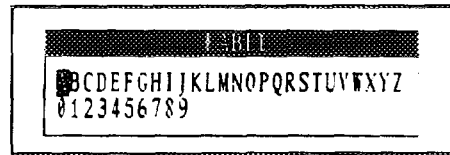

Figure 5.6-4 Entering the Title of the Saved Data



Press this softkey to use upper case letters.



Press this softkey to use lower case letters.

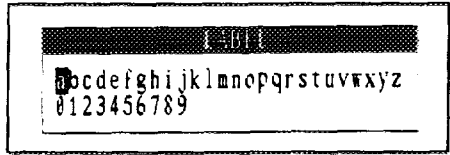

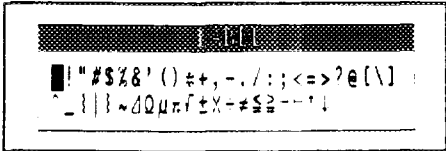
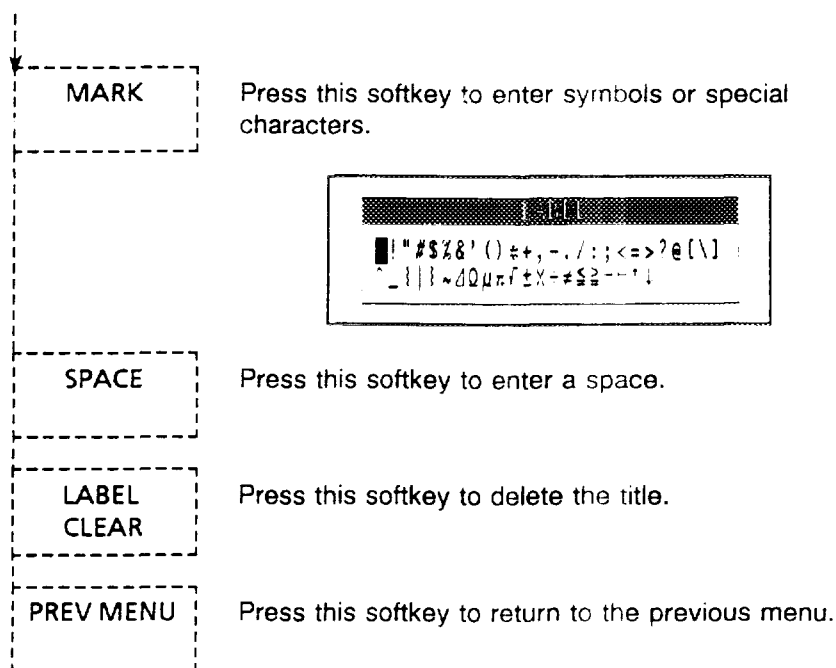

(6) Protecting Saved Data

To prevent the analyzer from writing to the selected channel, press the following keys:

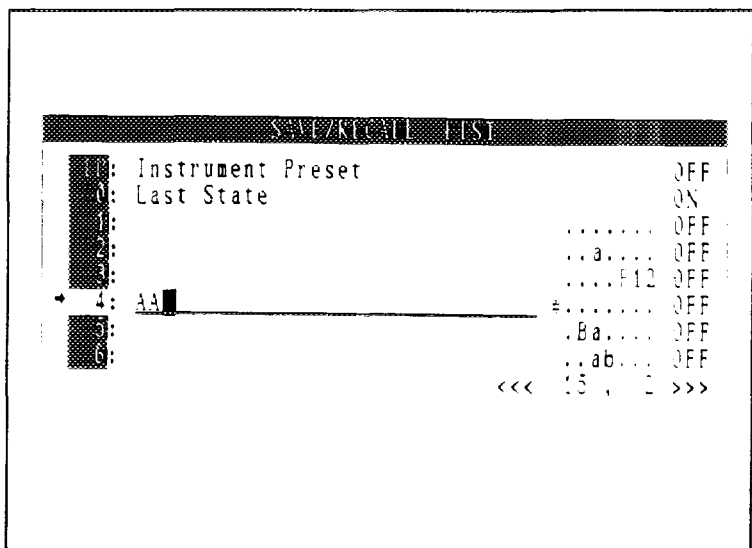
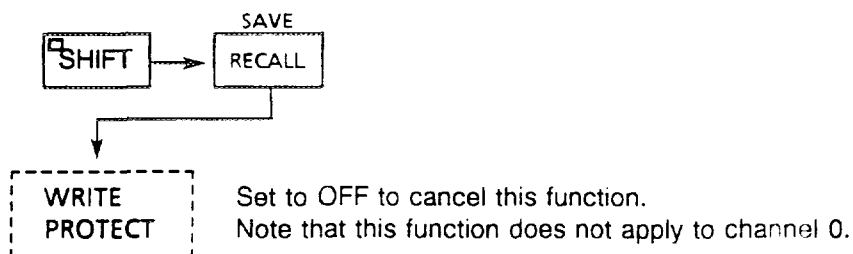

(7) Selecting the Type of Item to Be Saved

The save item function lets you specify whether to save trace A data, trace B data, or both, for the various data types. You can store more than one data type in a channel. Use this function by pressing the following keys:

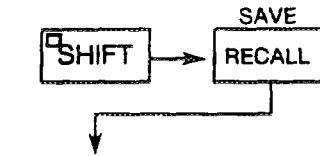

The save/recall list appears for you to select the data types you want to store. (If there is currently no data for a data type, it remains OFF.) After making the settings you want, return to the SAVE menu

and press  .

The selected items are saved.

NOTE

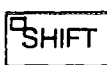
The save item settings are cleared every time you press  and all data types are set to ON. To cancel a particular data type, set that type to OFF (see below).

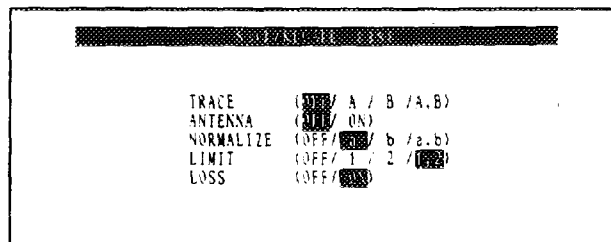
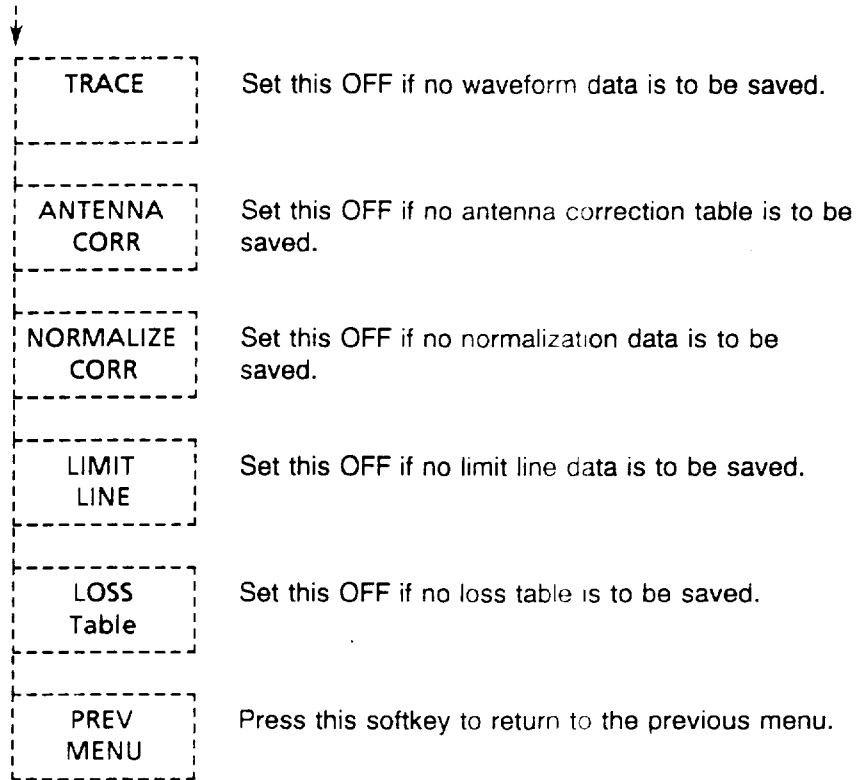

Figure 5.6-5 Selecting the Data Type to Be Saved



(8) Initializing the Saved Data

The analyzer uses the settings saved in channel IP to initialize the analyzer when the key is pressed. These settings remain in channel IP even after turning off the analyzer. To return these settings to the factory defaults, press the following keys:

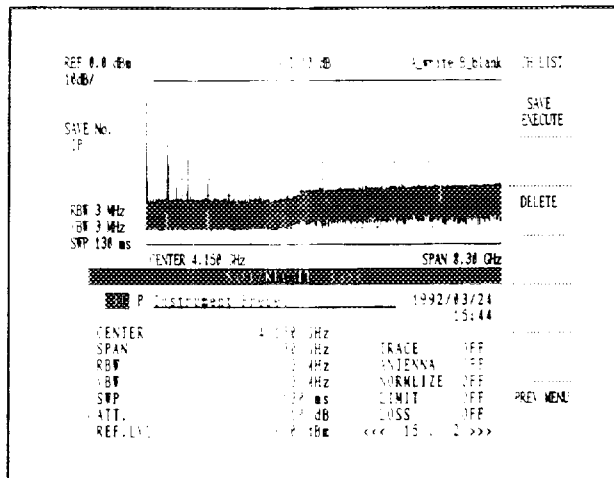
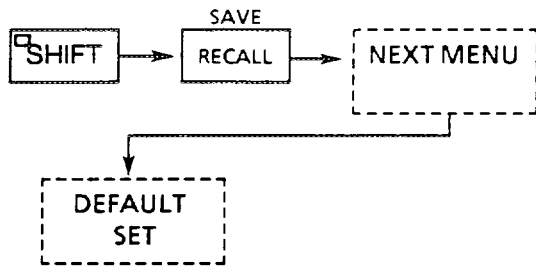
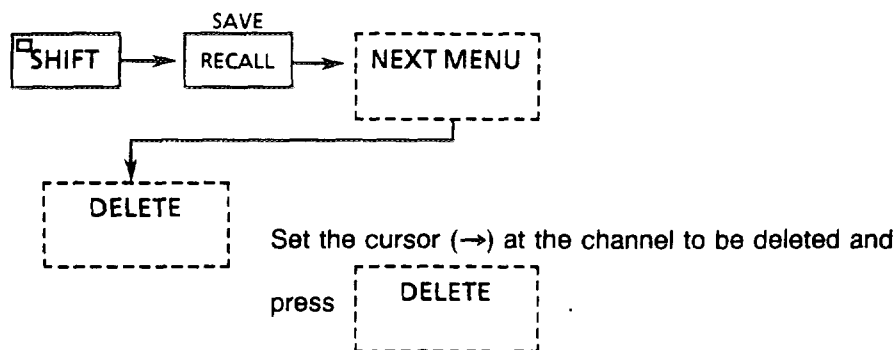

Figure 5.6-6 Listing the Initialization Data

(9) Deleting the Saved Data

To delete data from a channel, press the following keys:



NOTE

You cannot delete data from channel 1P, channel 0, or any channel that has write protect set to ON.

5.6.2 Recall Function

Press .

The list appears at the lower half of the screen. (The list does not appear if RECALL is set to FAST.)

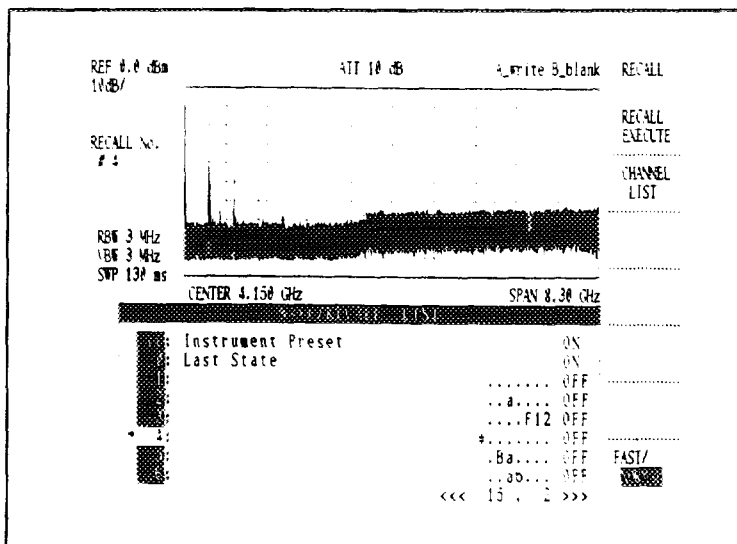
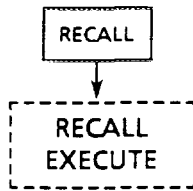

Figure 5.6-7 Recall Data List

To recall the data list (described in section 5.6.1 (1)), press the following keys:

(1) Recalling Data

To recall the data in the selected channel, press the following keys:



Press this softkey to recall the selected channel.
 If you select channel 1P or 0 through 15, the data is recalled from the analyzer's back-up memory.
 If you select channel 16 or above, the data is recalled from the memory card.

(2) Recall Data in Detail

To view detailed information about the data in a selected channel, set the cursor (→) at the channel number and press

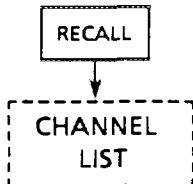

One of the screens shown in Figure 5.6-8 appears.

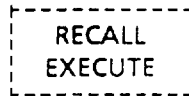

Press this softkey to recall the data in the selected channel.

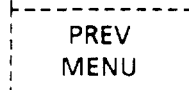

Press this softkey to return to the previous menu.

① When setting data is contained

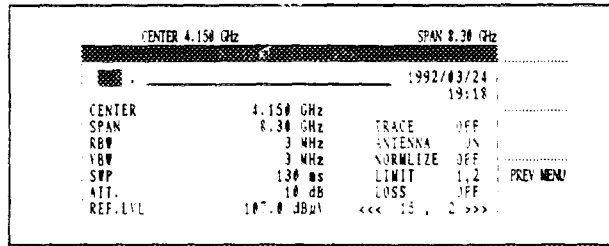

② When soft menu is contained

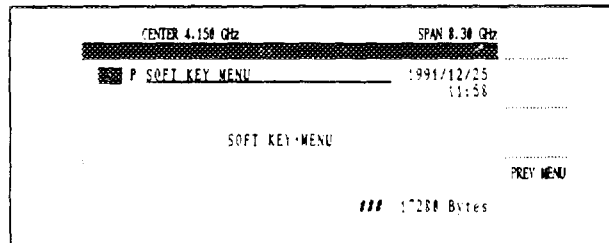

③ When no data is contained

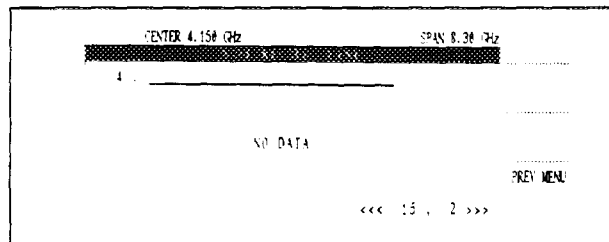
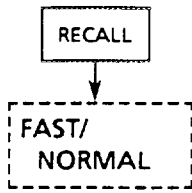

Figure 5.6-8 Recall Data in Detail

(3) Selecting the Recall Data Mode



Use this softkey to select FAST or NORMAL.
 (FAST only applies to channels 0 through 9 of the internal back-up memory)

- When NORMAL is selected, recall data by selecting a channel from the save/recall list and pressing

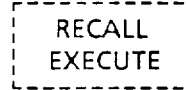

- When FAST is selected, the save/recall list does not appear. Just press one of the numeric keypad keys (0 through 9). It is not necessary to press

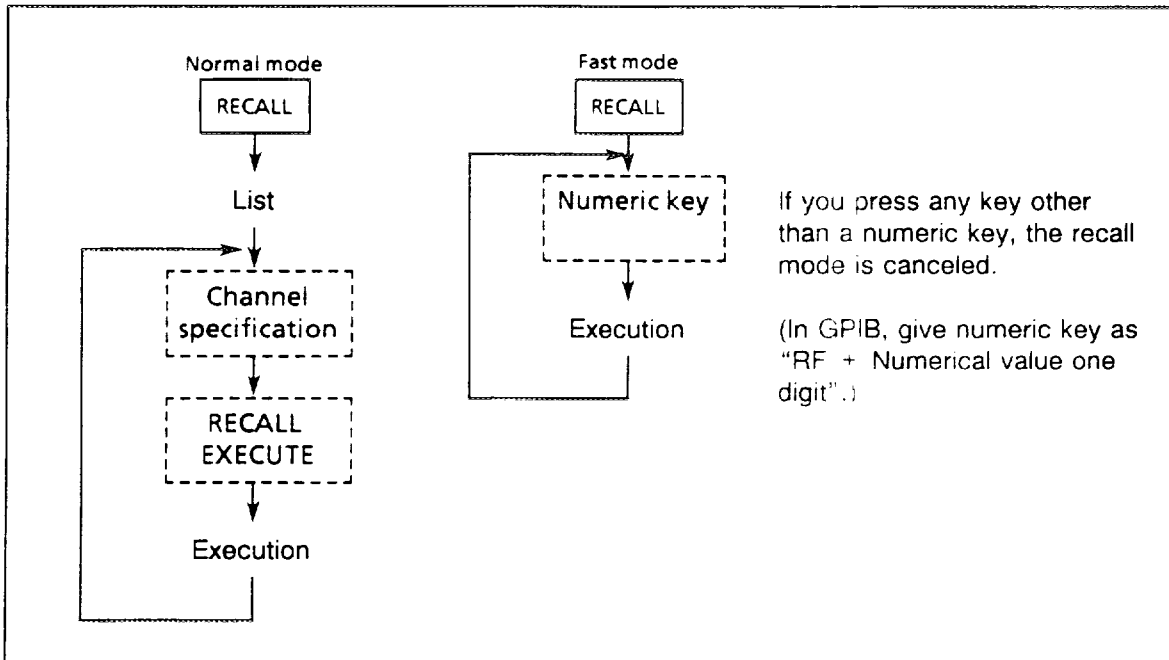
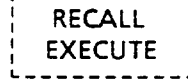

NOTE

FAST only applies to the internal memory. You cannot use FAST to recall data from the memory card.

5.7 Preset and Last State Functions

The preset and last state functions allow you to switch quickly between two setting states. Access these functions with the PRESET and LAST S keys, respectively. The PRESET key resets the analyzer's settings to their factory default state, or to a user-defined state stored in the IP channel (memory location). The LAST S key resets the analyzer's settings to the values they had just before the PRESET key was pressed.

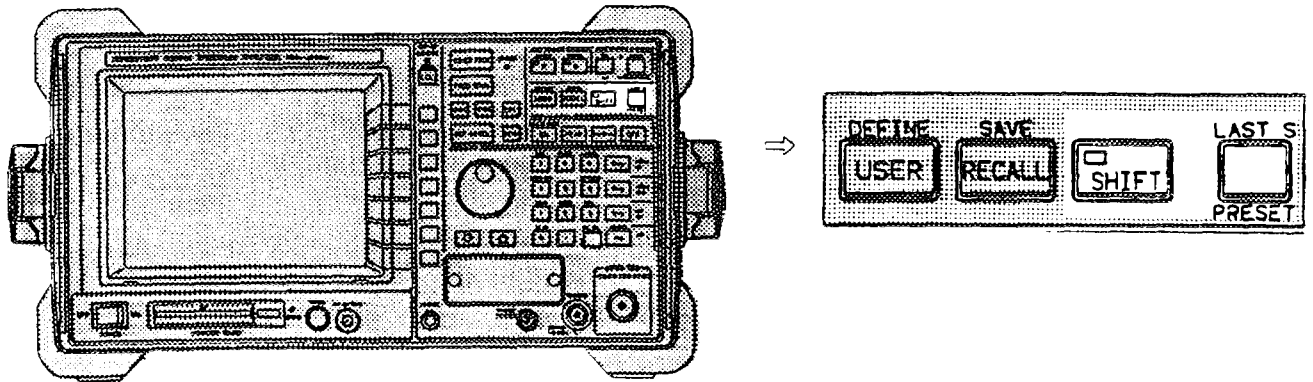

5.7.1 Preset

(1) Factory Default Settings

The PRESET key restores the factory default settings listed below.

Parameter	R3265A (R3271A) Setting
Center frequency	4.15 GHz (13.25 GHz)
Frequency span	8.3 GHz (26.5 GHz)
Reference level	0 dBm
Sweep time	AUTO 130 ms (400 ms)
Resolution bandwidth	AUTO 3 MHz
Video bandwidth	AUTO 3 MHz
Input attenuator	AUTO 10 dB
Trigger mode	FREE RUN
Trace mode	A WRITE B BLANK
Marker	OFF
Display line	OFF
Label function	OFF
Vertical axis scale	10 dB/div

(2) Storing a User-Defined Preset State

① Enter the settings you want.

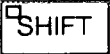
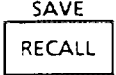
② Press   .

Back-up memory data is listed.

③ Select channel IP with the cursor.

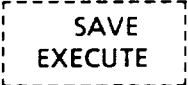
④ Press  .

Hereafter, the analyzer will be set to the state you defined when you press



(3) Canceling a User-Defined Preset State

Press the following keys:

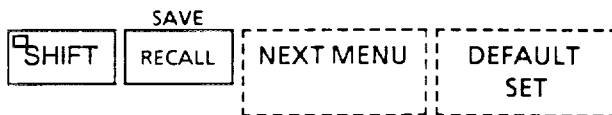

5.7.2 Last State

To restore the analyzer to the state it was in just before PRESET was pressed, press the following keys:

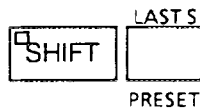

NOTE

The state when the analyzer's power is turned OFF remains when the power is turned ON again.

5.8 Calibration Function

The calibration function lets you fine tune the amplitude section of the analyzer to improve its accuracy. (You should also return the analyzer to an Advantest service center once a year for a complete calibration and performance check.)

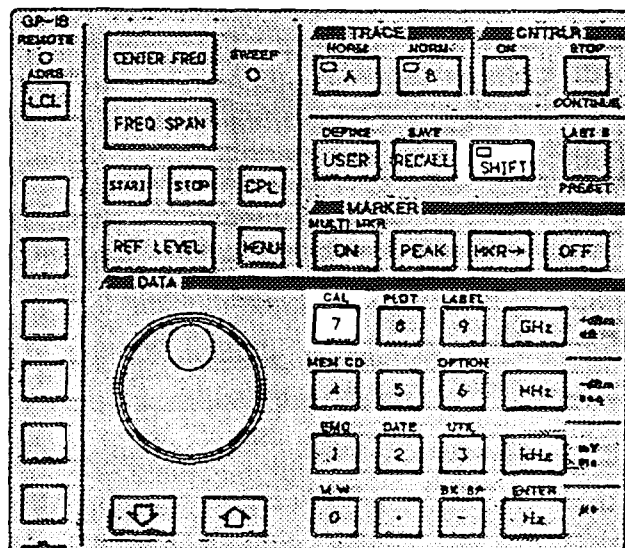

(1) Calibration Items

The calibration function adjusts the following:

- Absolute error in the resolution bandwidth 300 kHz correction signal output (-10 dBm, 1 dB/div)
- IF filter switching level error in the resolution bandwidth 10 Hz to 3 MHz
- Screen vertical axis linearity in LOG 10 dB/div, 5 dB/div, 2 dB/div, and 1 dB/div
- Switching error in LOG 10 dB/div to 0.1 dB/div
- IF step AMP switching error
- Input attenuator switching error
- PBW (noise power bandwidth)

NOTE

1. Before calibrating the analyzer, let it warm up for at least 60 minutes.
2. Before using the CAL key, connect the CAL OUT output connector on the front panel to the RF input on the front panel with a cable such as the MC-61 10 cm cable.

(2) Calibration Menu

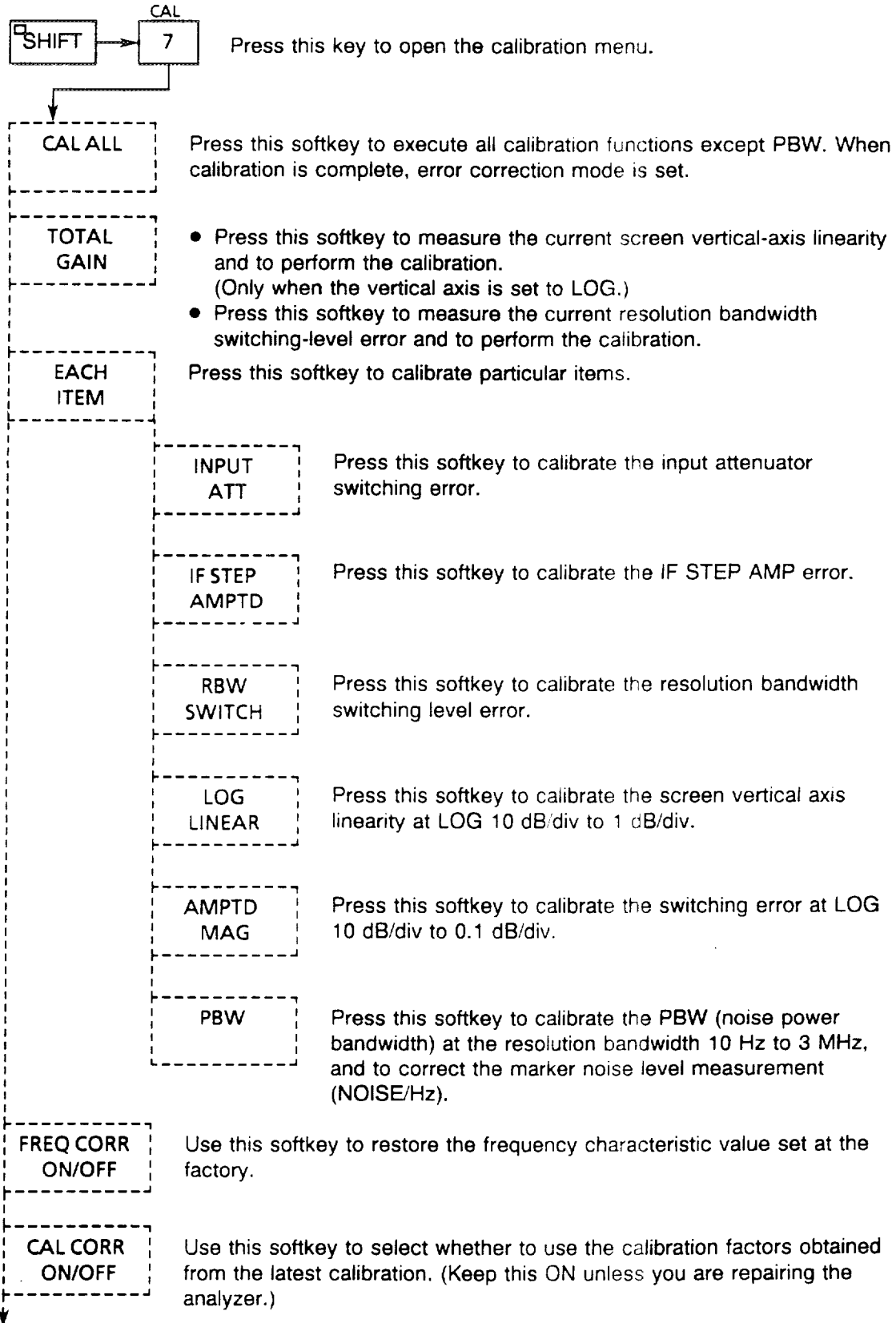

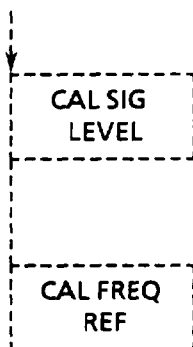

Press this softkey to specify the calibration signal output level from -10 dBm to -30 dBm in 0.5 dB increments using the numeric keypad, data knob, or step keys.

Press this softkey to calibrate the internal frequency reference source.

Set the reference value with the data knob and press

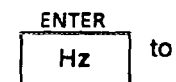

to

The accuracy of the frequency reference is 2×10^{-7} /year.

5.9 Plotter Functions

The plotter functions let you use a variety of plotters with the analyzer. You can plot up to four waveforms or tables on a page and use up to eight pens to plot different display elements in different colors. You can use the panel keys while the plotter operates.

(1) Compatible Plotters

Connect the plotter to the analyzer with a GPIB cable as shown in Figure 5.9-1. Table 5.9-1 lists plotters that are compatible with the analyzer.

Table 5.9-1 Compatible Plotters

Manufacturer	Plotter
ADVANTEST	R9833
HP	HP7470A, HP7475A, HP7440A, HP7550A

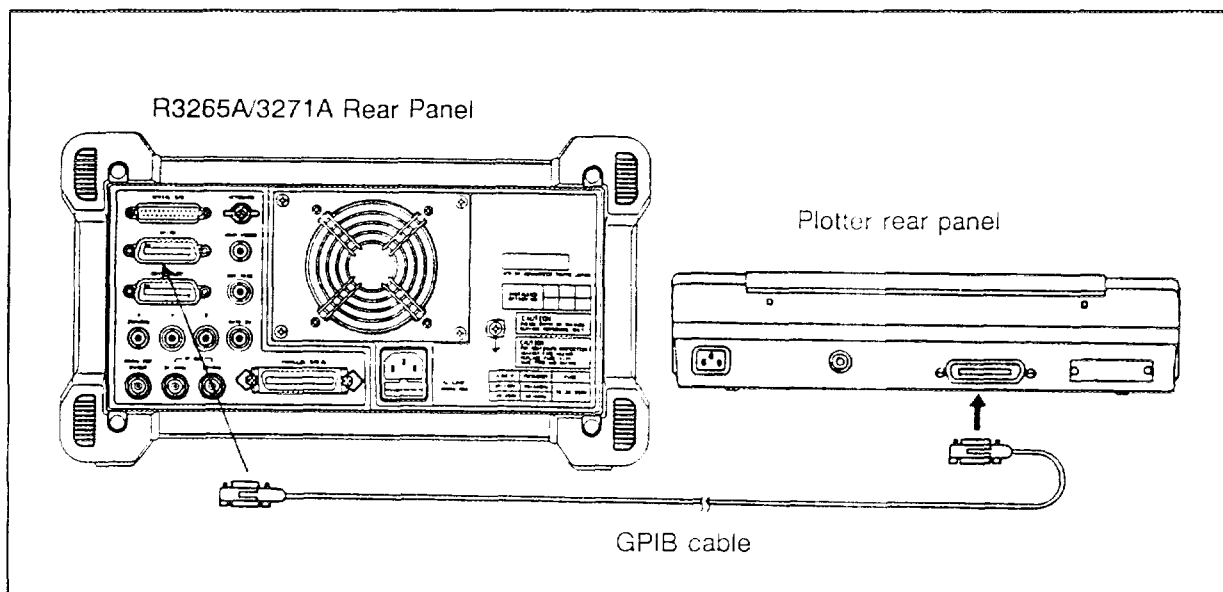

Figure 5.9-1 Plotter Connection

CAUTION

1. Before connecting the GPIB cable, turn off the analyzer and plotter.
2. Make sure you know how to operate the plotter.

(2) Setting Up the Plotter

Set the plotter address to Listen Only mode or 0 to 30. (Refer to the plotter's instruction manual for instructions.) Make sure you assign the plotter to an unused GPIB address. Other settings may be required depending on the plotter type.

For example, to set the Advantest R9833 plotter to use A4 size paper (Listen only mode) in the lateral direction, set the DIP switches as shown.

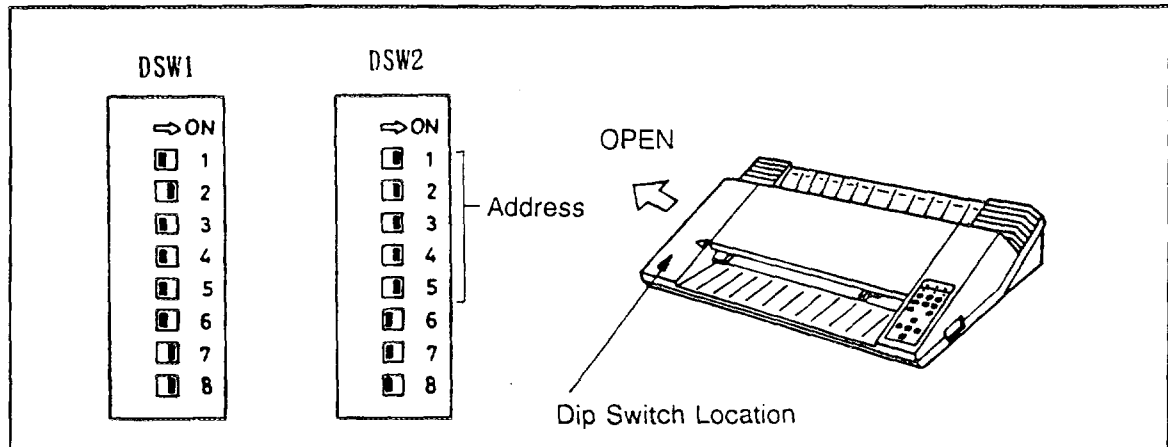

Figure 5.9-2 Example Dip Switch Setting

(3) Using the Plotter

① Plotter Operation Window

Press **SHIFT** **PLOT** **8**.

The following plotter operation window appears. You will use this window to control the plotter, as described below.

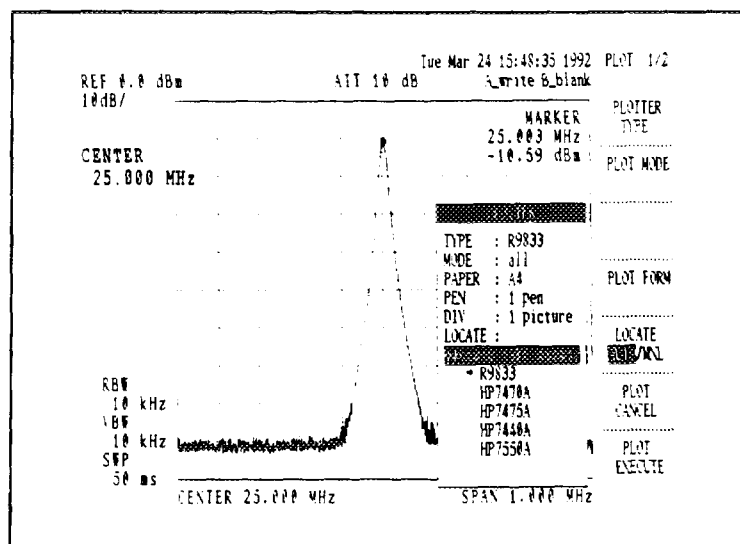
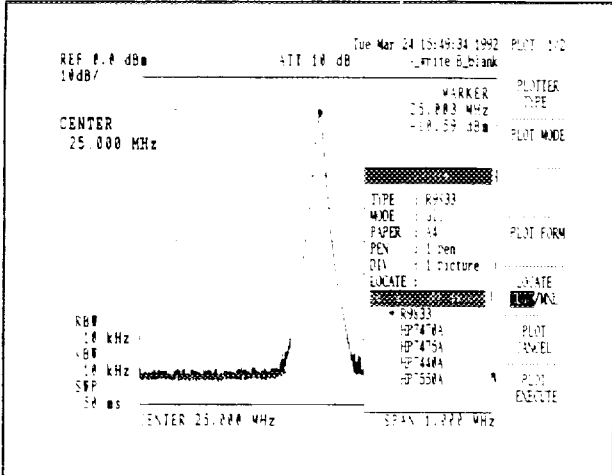
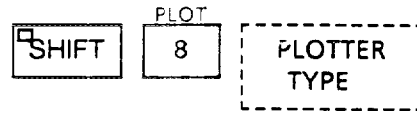

Figure 5.9-3 Plotter Operation Window



② Select the plotter model. Press



Press the PLOTTER TYPE softkey to move the cursor (→) down the list.

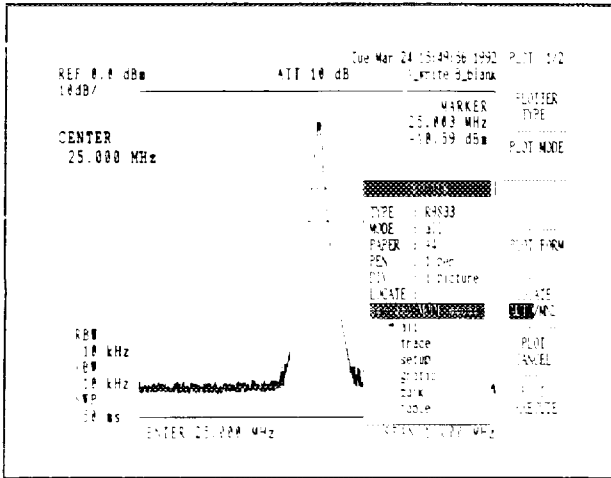

③ Select the plot mode. Press

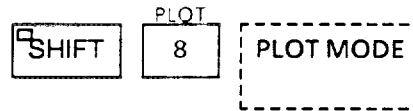

If you select table mode, also select the table type as described in step ④.

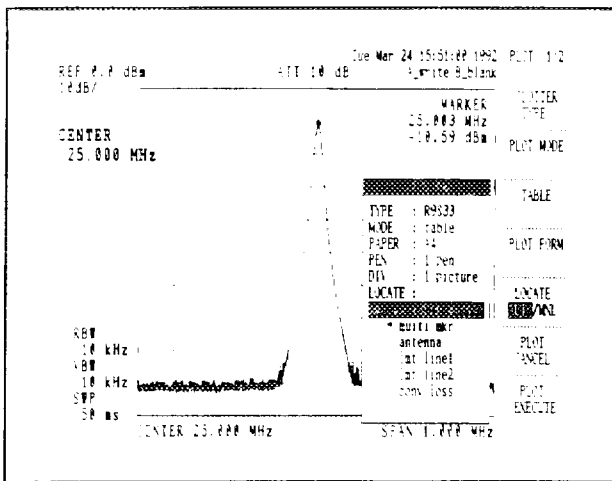

④ Select the table type. Press

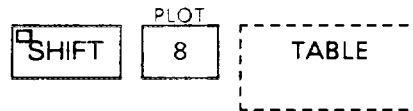

The table key only appears if you already selected table as the plot mode.

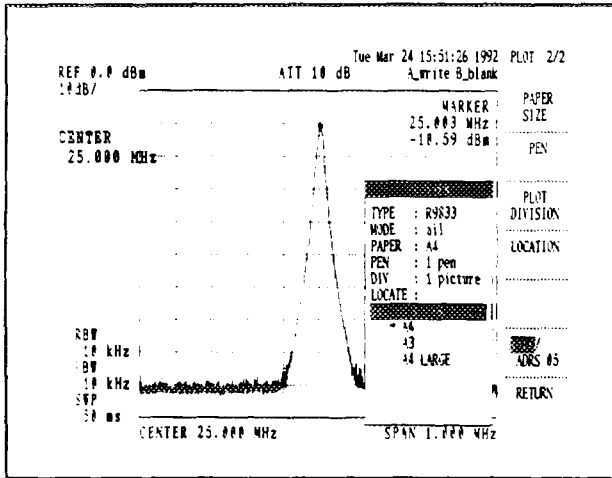

⑤ Select the plotter paper size. Press

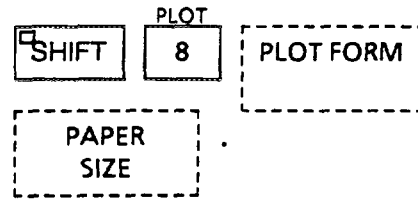

Press the PAPER SIZE softkey to move the cursor (→) down the list.

- Selecting the "A4 LARGE" enables to plot out the data approx. 1.6 times larger than A4 size. (Paper size is A4.)

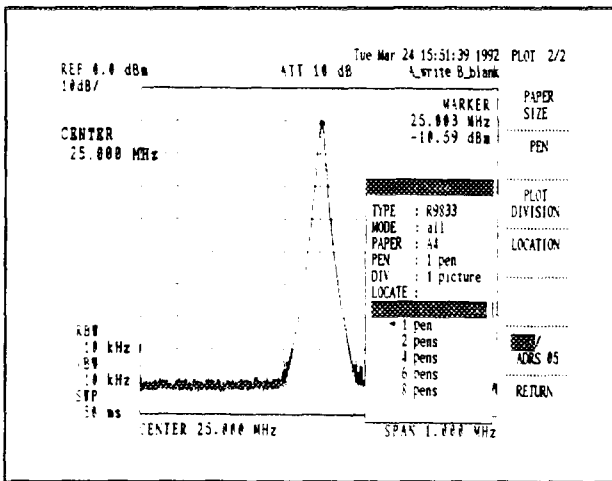

⑥ Select the number of pens. Press

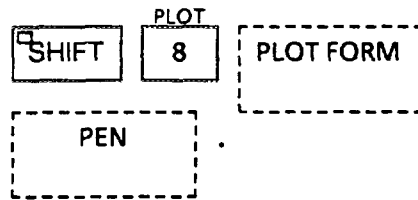

Press the PEN softkey to move the cursor (→) down the list.

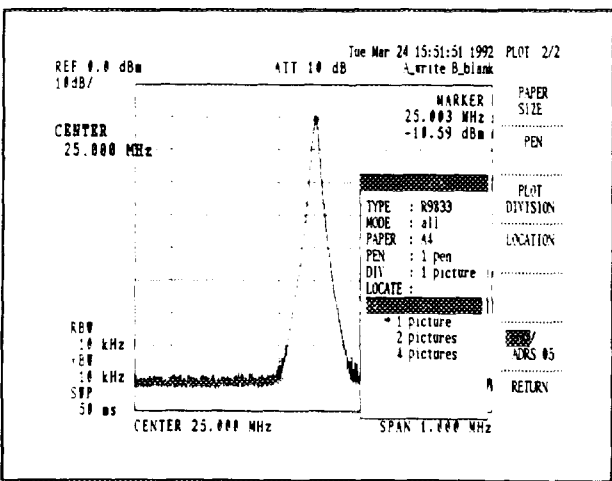

⑦ Select the number of plots per page. Press

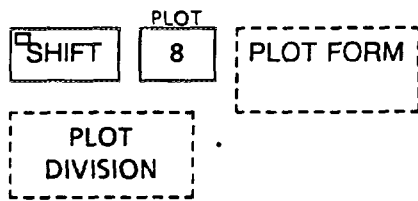

Press the PLOT DIVISION softkey to move the cursor (→) down the list.

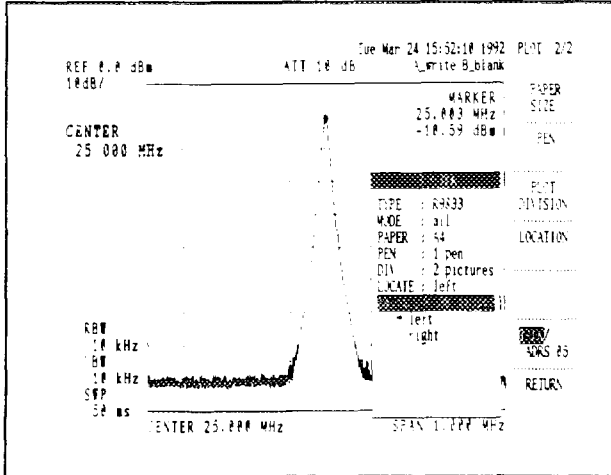

(Specified to be divided into two parts.)

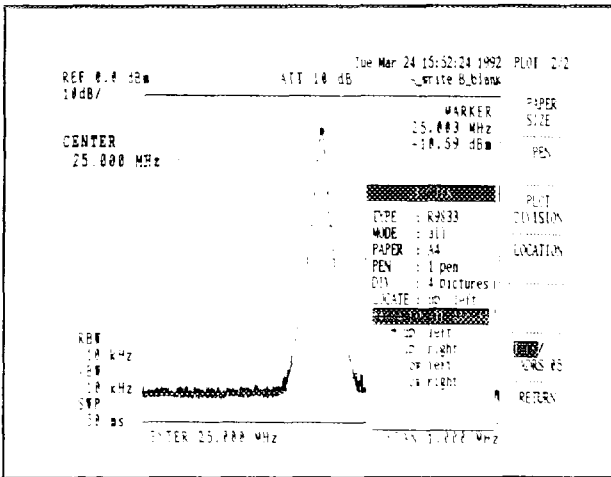

(Specified to be divided into four parts.)

- ③ Select which part of the page to plot on next if you are making more than one plot per page. Press

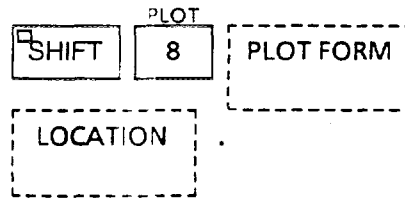

Press the LOCATION softkey to move the cursor (→) down the list. The choices differ depending on whether you are making two or four plots per page.

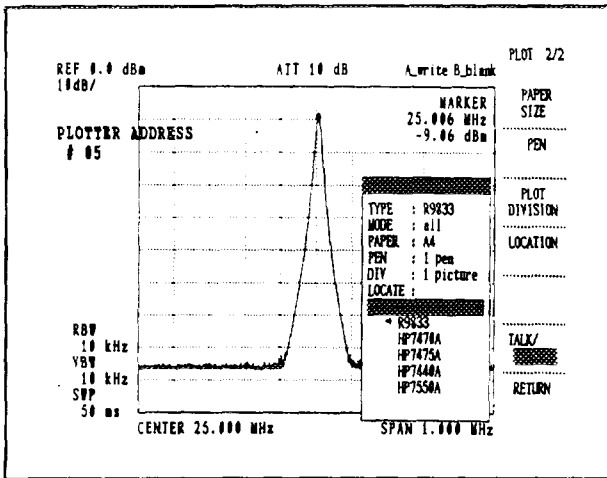

⑨ Switching the talk only output/
addressing output

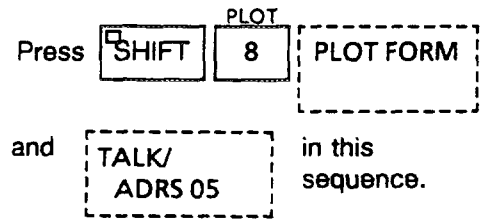

And set the talk only output or the
addressing output.

⇐ If the addressing output is
selected:
specify the plotter address with
the numeric, step keys and
data knob.
Also, set the plotter to the same
address.

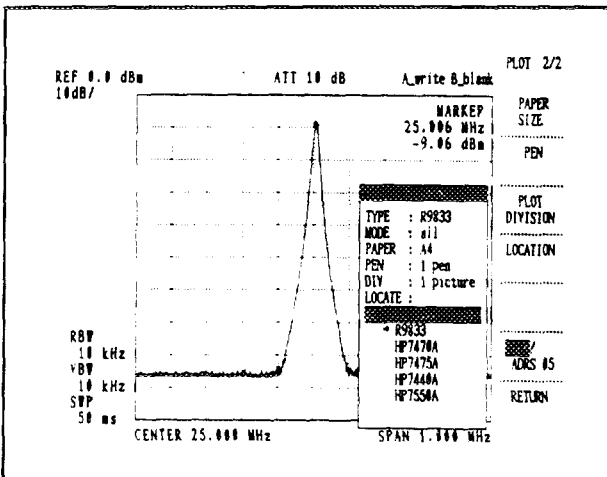

⇐ If the talk only output is
selected:
Set the plotter to the listen
only mode.

⑩ Auto/Manual Selection of the Plot
Position on the Page

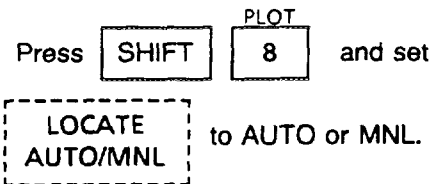

Select AUTO to consecutively plot
all positions on the page.

⑪ Plotting

Press **SHIFT** **8** **PLOT EXECUTE**.

Plotting begins using the settings you've made, and the display returns to the normal screen.

You can use the front panel keys while the plotter is working. However, you cannot begin another plot until the first one finishes. An error message appears if you attempt this, as shown below.

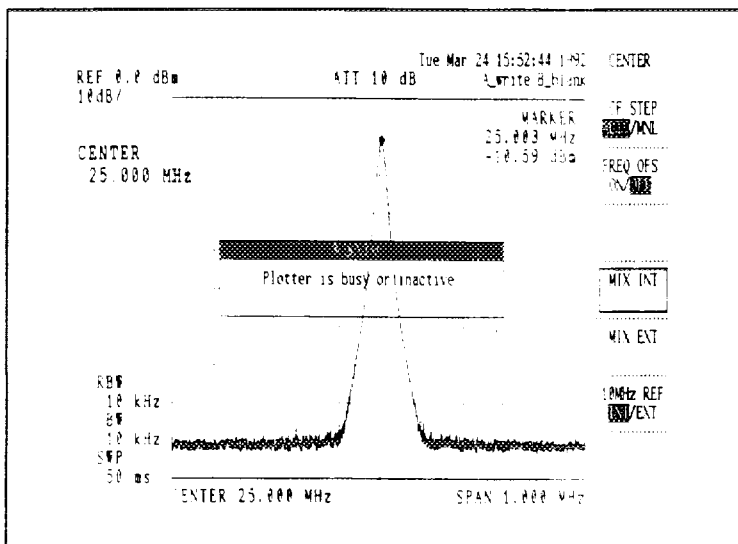

Figure 5.9-4 Plotter Error Message

⑫ Canceling the Plot

Press **SHIFT** **8** **PLOT CANCEL** to cancel a plot in progress.

Note that if the plotter has a built-in buffer, the data in the buffer is plotted before the plotter stops.

NOTE

1. Be sure to read the plotter's instruction manual for more information.
2. The analyzer is compatible with plotters based on the HP-GL. Set your plotter to the correct mode.
Note that some plotters may not be capable of printing multiple plots on a page. For example, the HP7470A cannot print two plots on a page.
3. If you are using an HP7475A plotter, set its DIP switch to US/A4 or US/A3 paper size.

Table 5.9-2 Plotter Pen Assignments

1-pen mode	Pen 1	Frame, marker, window, limit line, characters, display line, waveform A, and waveform B
2-pen mode	Pen 1 Pen 2	Frame, marker, window, limit line, waveform B Waveform A, characters, display line
4-pen mode	Pen 1 Pen 2 Pen 3 Pen 4	Frame Display line, marker, window, limit line, characters Waveform A Waveform B
6-pen mode	Pen 1 Pen 2 Pen 3 Pen 4 Pen 5 Pen 6	Frame Marker, characters Waveform A Waveform B Display line Window, limit line
8-pen mode	Pen 1 Pen 2 Pen 3 Pen 4 Pen 5 Pen 6 Pen 7 Pen 8	Frame Marker, characters Waveform A Waveform B Display line (Unused) Window Limit line

5.10 Label Function

The label function lets you create a label for on-screen display. If you save the trace, the label is stored with the trace. (The label is different than a trace's title, which appears in the save/recall list.)

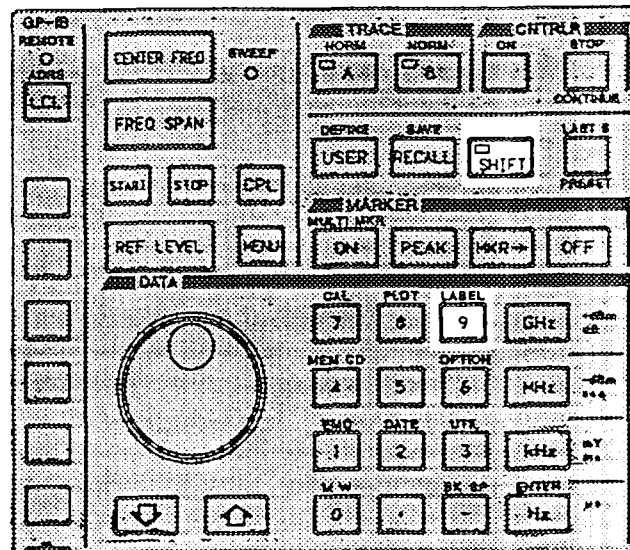

(1) Labeling Procedure

- ① Press . The label window appears for you to select characters.
- ② Label input position can be changed with the step key. When is pressed, the cursor moves right. When is pressed, the cursor moves left.
- ③ The character which wants to be input is set with the data knob. Use the data knob to select a character, and press to load the character.

Note 1 : When the input character is correct or delet, press .

Note 2 : If you press a key and hold it, the key repeats.

(2) The Label Menu

To open the label menu, press

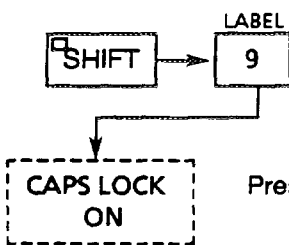

Press this softkey to select capital letters with the knob 

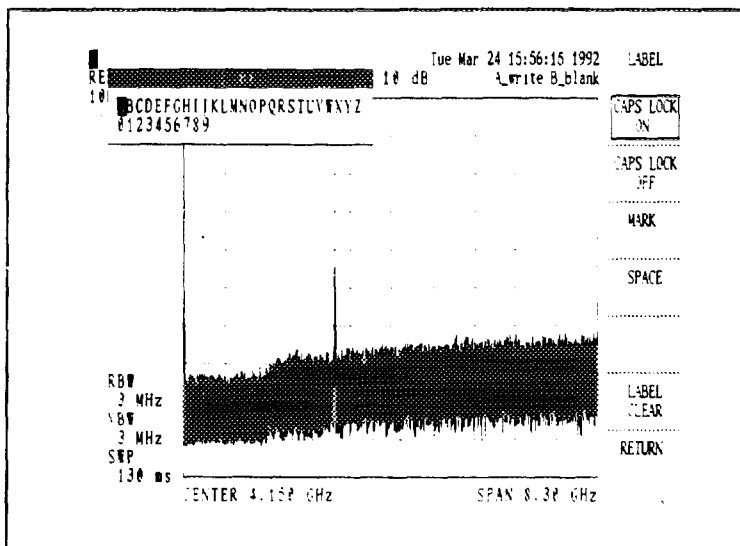

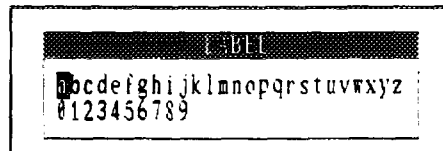

Figure 5.10-1 Label Display



Press this softkey to select lower case letters with the knob 



Press this softkey to select symbol characters with the knob 

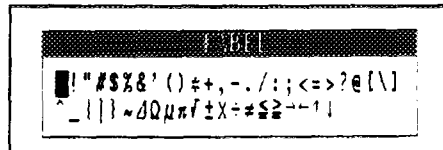

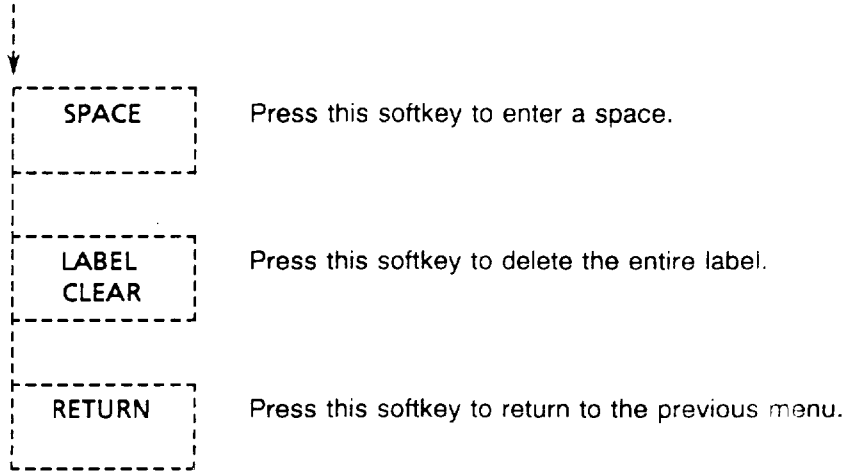

5.11 EMC Function

The Electro-Magnetic Compatibility (EMC) function lets you use the analyzer as a receiver.

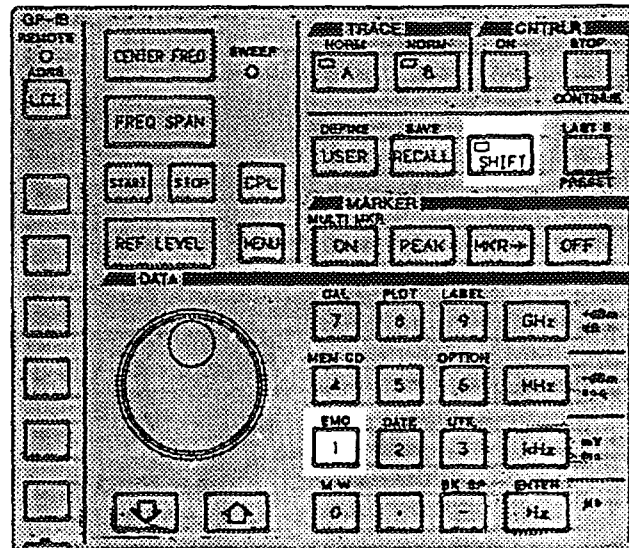

This lets you make the following common EMC measurements:

- Intensity of electric field interference (using an antenna)
- Voltage of the power source terminal (using a quasi-power source circuit)
- Interfering power (using an absorption clamp)

For a detailed explanation of EMC measurements, see the "EMI/EMC Measurement System Guide Book" available from Advantest.

(1) Antenna Factor Correction

Use this function to correct the antenna factor used when measuring electric field intensity with an antenna. The analyzer calculates the correction factor and the level appears in $\text{dB}_\mu \text{V/m}$.

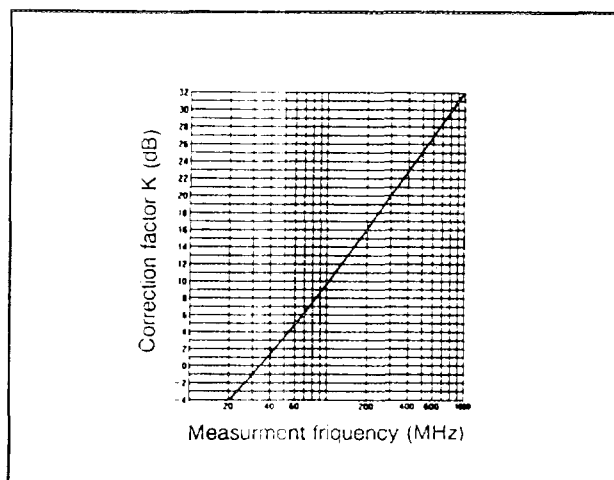
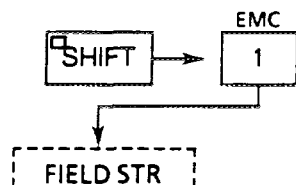
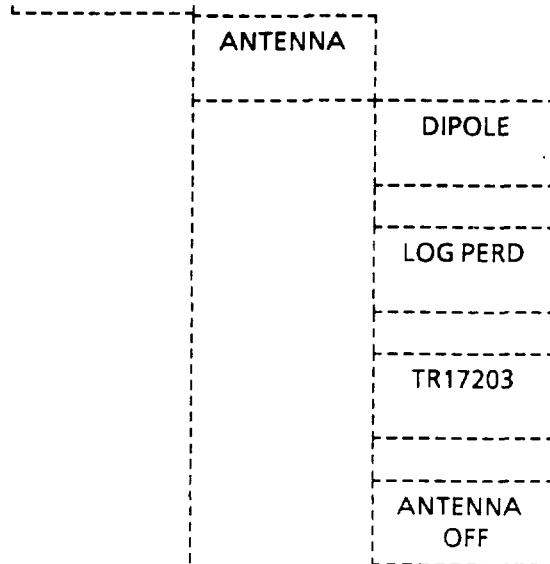

Figure 5.11-1 TR1722 Antenna Factor



Press this softkey to correct the half-wavelength dipole antenna factor (TR1722).

Press this softkey to correct the logarithmic cycle antenna factor (TR1711).

Press this softkey to correct the active antenna factor (TR17203).

Press this softkey to cancel all antenna factor corrections.

Note: the above-mentioned antenna corrections compensate for loss from a 5D2W 10 M cable.

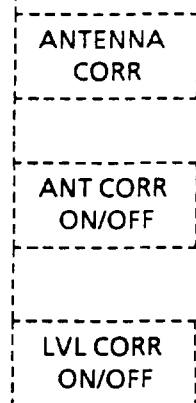

Press this softkey to create a custom antenna factor as explained in paragraph (3), Limit Line Function, below.

Use this softkey to turn the antenna correction factor ON or OFF. When ON, the correction factor is added to the current WRITE trace (units are in $\text{dB}_\mu \text{V/m}$).

Use this softkey to turn the level correction ON or OFF. This mode uses the units specified in the UNITS menu.

(2) Selecting Detection Mode

This function lets you select the detection mode defined by CISPR (an international standards organization) specifications.

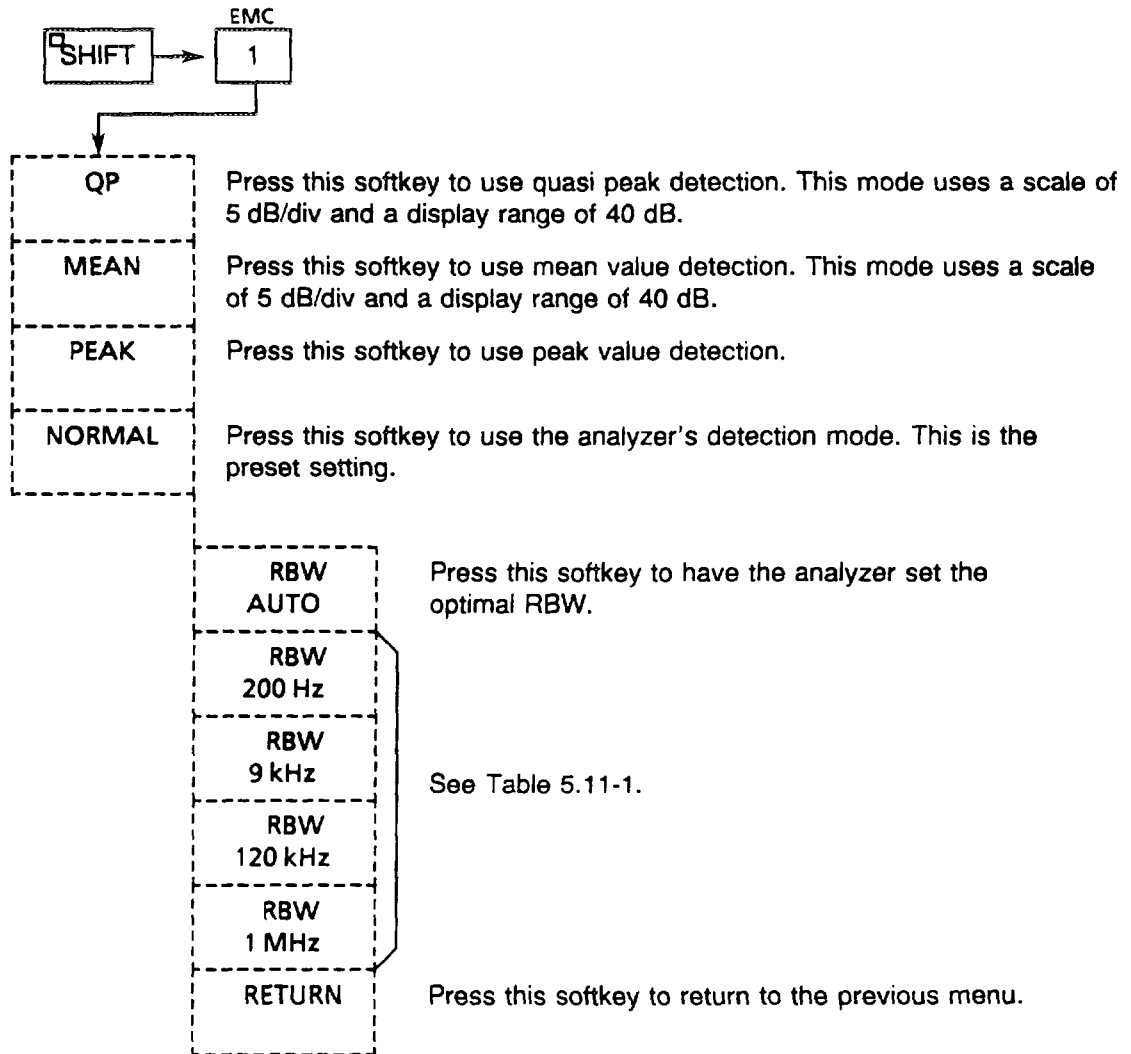

Table 5.11-1 The CISPR Specifications for RBW

Measurement Bandwidth		RBW (6 dB bandwidth)	Sweep Time Setting
A	10 kHz to 150 kHz	200 Hz	1 sec per 200 Hz frequency span
B	150 kHz to 30 MHz	9 kHz	1 sec per 10 kHz frequency span
C	30 MHz to 300 MHz	120 kHz	1 sec per 100 kHz frequency span
D	300 MHz to 1 GHz	120 kHz	

(3) Limit Line Function

This function displays a border that shows the spectrum's upper limit or lower limit. This enables you to compare data to these limits.

① Data table Description

Two limit lines can be used: limit line 1 and limit line 2.

You can select either the frequency domain or the time domain (for zero span mode) for each limit line.

You can enter up to 51 data points (specifying frequency and level for each) for each limit line. The frequency data must be in the range from 0 Hz to 999.999 GHz, the time data must be in the range from 0 s to 1000 s, and the level data must be in the range from -240 dBm to 100 dBm. The level data can also be entered in the same units as the reference level (except for the units V and W).

Enter data in input mode, and modify data in modify mode.

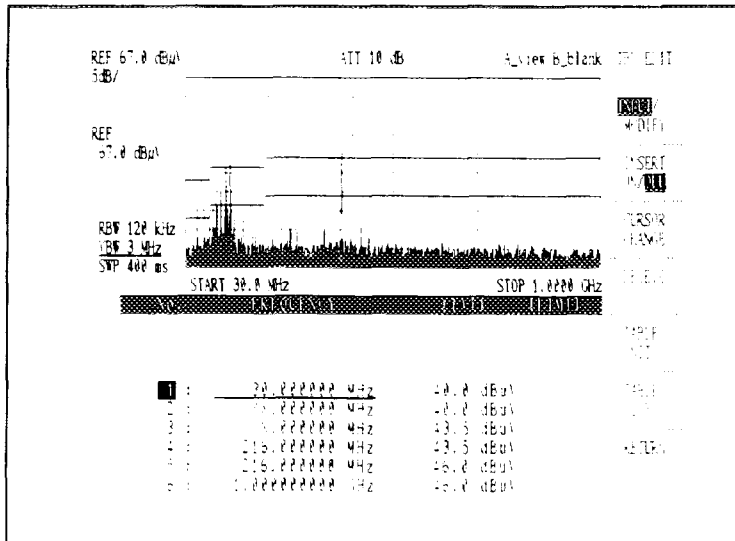
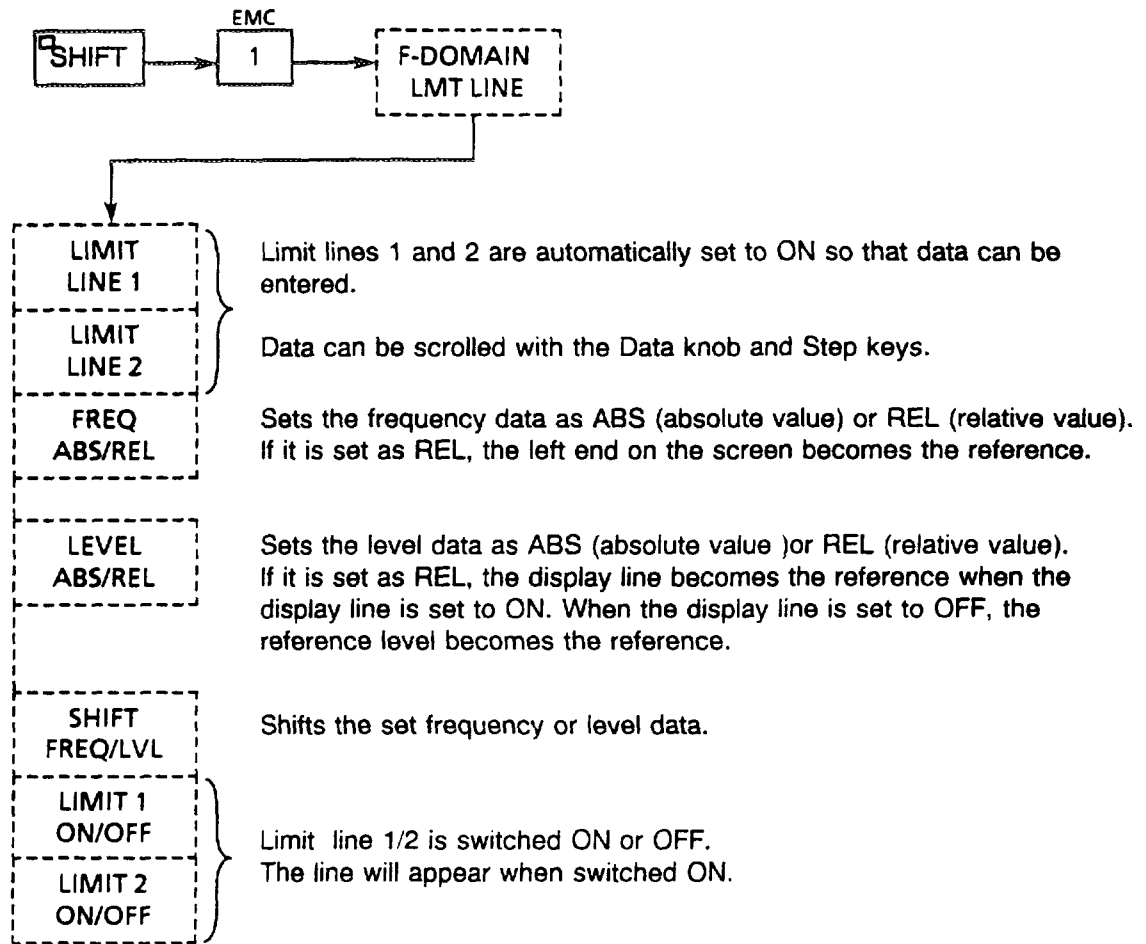

Figure 5.11-2 Entering a Limit Line

② Limit Line Menu

②-1 Frequency domain data input



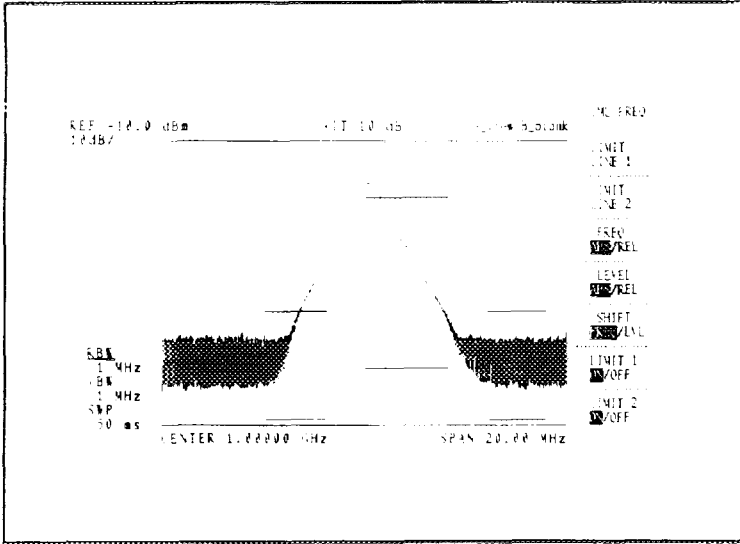

Figure 5.11-3 The displayed waveform and limit line do not match

If the displayed waveform and limit line do not match as shown in Figure 5.11-3, move the vertical and horizontal axes with SHIFT FREQ and SHIFT LEVEL, and the waveform and limit line match as shown in Figure 5.11-4.

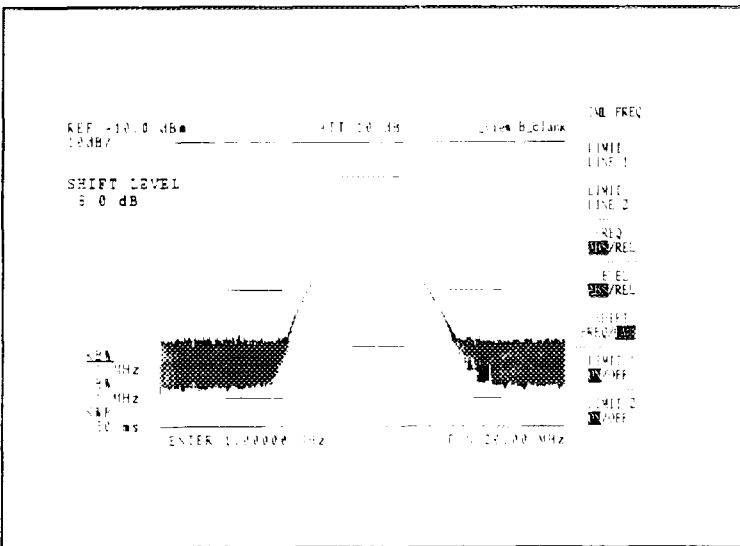
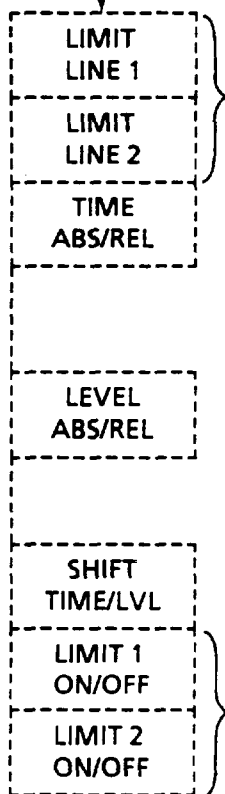
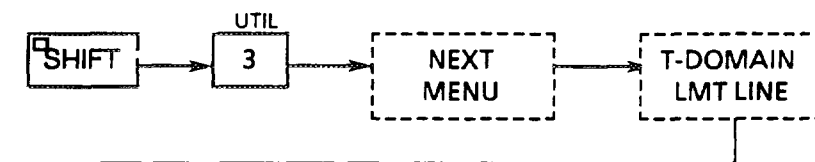

Figure 5.11-4 The displayed waveform and limit line match

②-2 Time domain data input



Limit lines 1 and 2 are automatically set to ON so that data can be entered.

Data can be scrolled with the Data knob and Step keys.

Sets the time data as ABS (absolute value) or REL (relative value). If it is set as ABS and the delay sweep is set to ON, the delay time becomes the reference. If it is set as REL, or if the delay sweep is set to OFF, the left end on the screen becomes the reference.

Sets the level data as ABS (absolute value) or REL (relative value). If it is set as REL, the display line becomes the reference when the display line is set to ON. When the display line is set to OFF, the reference level becomes the reference.

Shifts the set time or level data.

Limit line 1/2 is switched ON or OFF. The line will appear when switched ON.

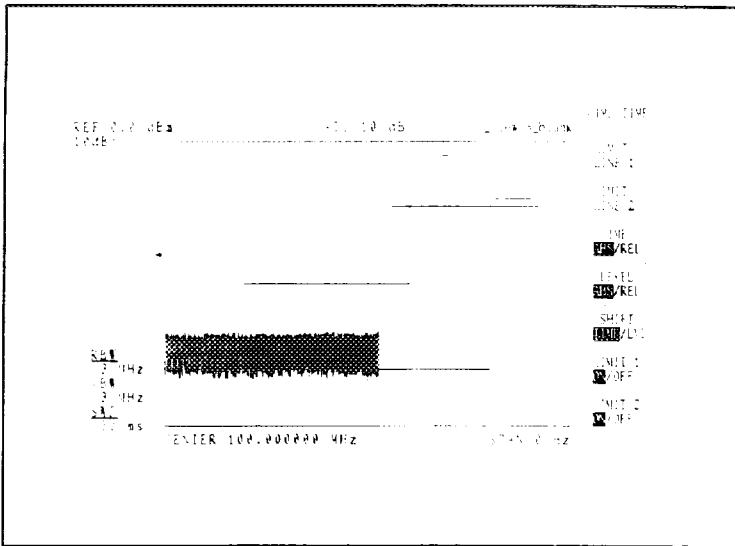

If the displayed waveform and limit line do not match as shown in Figure 5.11-5, move the vertical and horizontal axes with SHIFT FREQ and SHIFT LEVEL, and the waveform and limit line match as shown in Figure 5.11-6.

Figure 5.11-5 The displayed waveform and limit line do not match

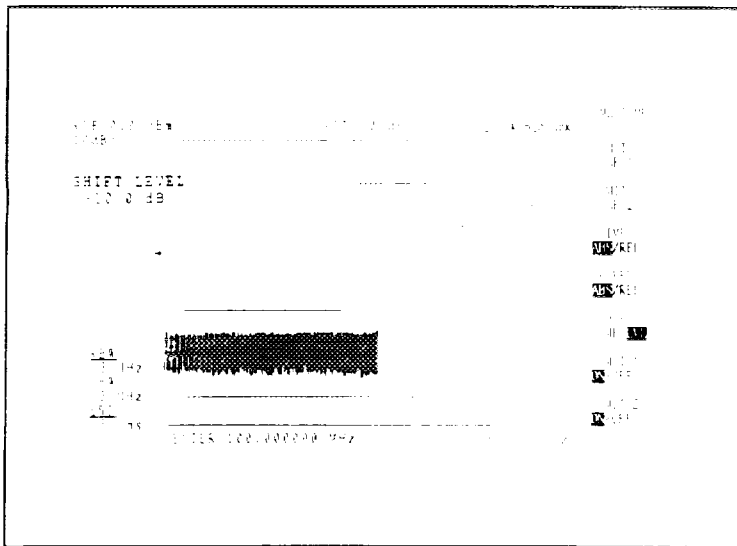
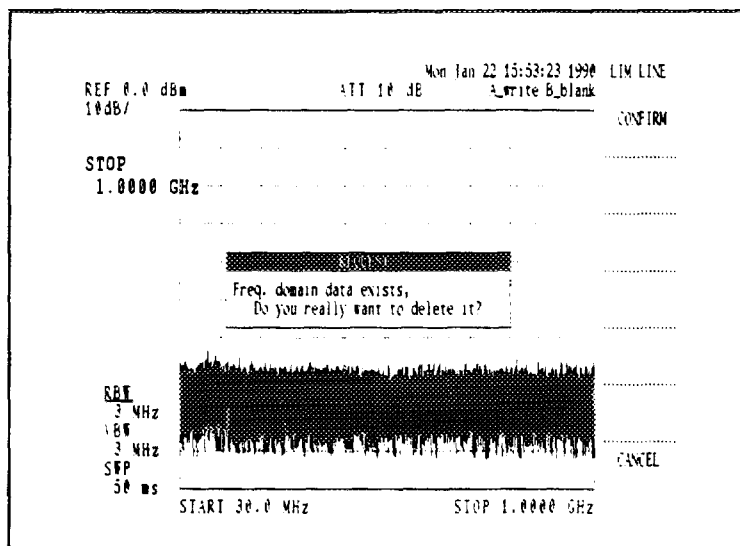
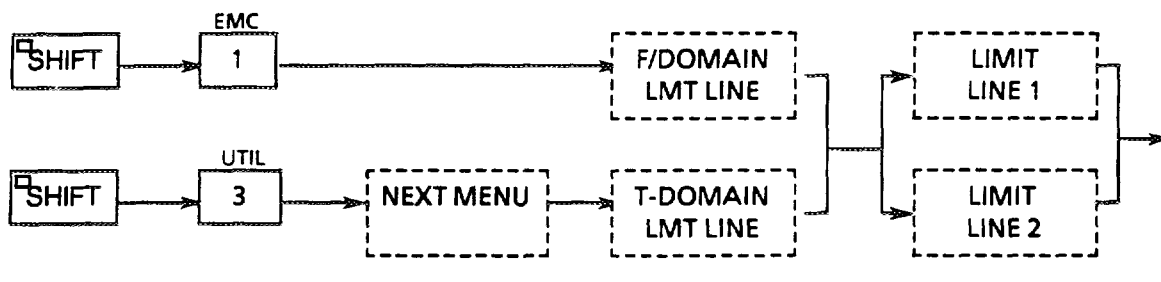

Figure 5.11-6 The displayed waveform and limit line match

②-3 Making a limit line table



The message shown above appears when you try to enter time domain data after entering frequency domain data.

Press **CONFIRM** to enter the data and delete the frequency domain data.

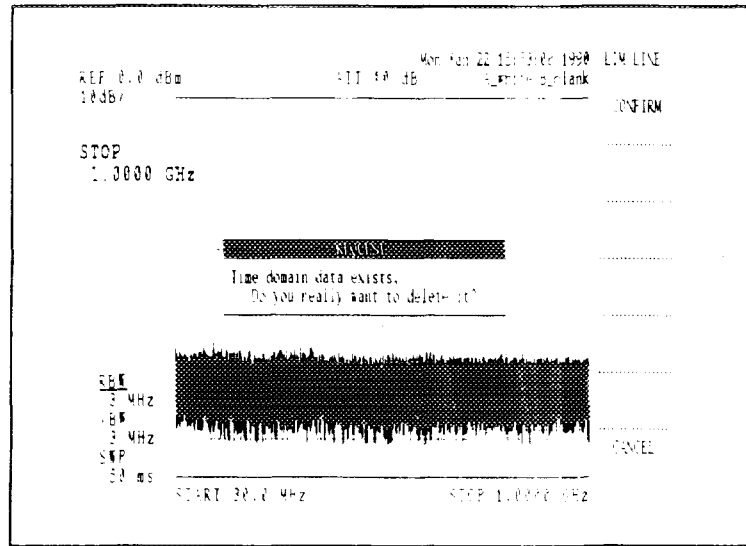

The message shown above appears when you try to enter frequency domain data after entering time domain data.

Press **CONFIRM** to enter the data and delete the time domain data.

- INPUT/MODIFY
- INSERT ON/OFF
- CURSOR CHANGE

Use this softkey to switch between input mode and modify mode. You can then enter or modify the item underlined. In input mode, enter frequency or time data, then level data. Each data point is defined by a frequency or time and a level. The data entered is sorted in ascending order by frequency or time. In modify mode, modify the frequency or level. The data is then re-sorted.

Use this softkey to insert a line at the cursor for data entry.

Press this softkey to move the input cursor between frequency or time and level.

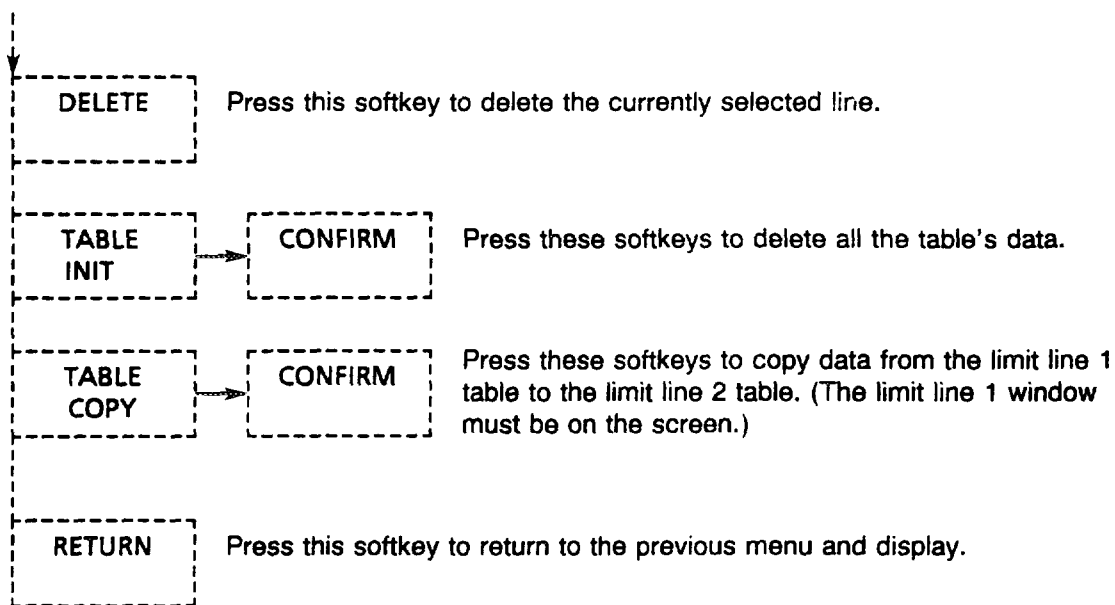

(4) Measuring the Power Source Terminal Voltage

Use a quasi-power source circuit to measure the power source terminal voltage as follows:

- ① Connect the signal source to be measured (the DUT) as illustrated in Figure 5.11-7.

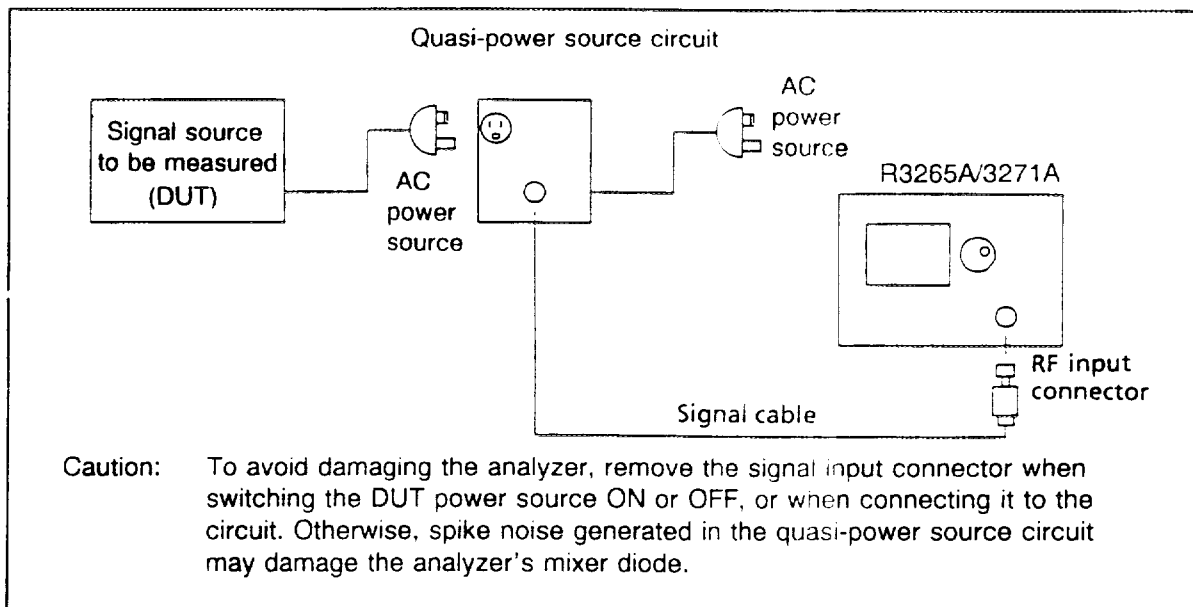
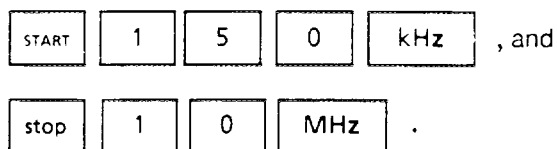
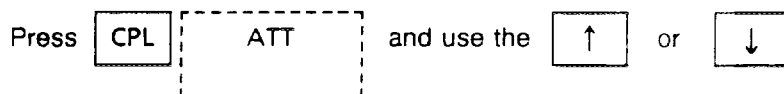

Figure 5.11-7 Measuring the Power Source Terminal Voltage

- ② Enter the start and stop frequencies to be measured. For example, if the start frequency is 150 kHz and the stop frequency is 10 MHz, you would press



- ③ Make sure the waveform level does not vary when you increase or decrease the attenuator by 10 dB. If it does, the analyzer's input stage is saturated, and you must increase the attenuator value or insert a band pass filter in the input.



step keys to vary the attenuator setting by 10 dB and confirm that the level does not vary.

④ Press **REF LEVEL** and use the knob  to set the signal at the reference level.



⑤ Specify the QP resolution bandwidth.

Press **SHIFT** **EMC 1** **QP** **BW AUTO**.

The resolution bandwidth (9 kHz) and the charge and discharge constant are automatically selected.

- Notes:
1. If the start and stop frequency are specified in multiple measurement regions, the resolution bandwidth is automatically selected according to the stop frequency.
 2. In QP mode, 5 dB/div is automatically set.

⑥ Set the sweep time according to Table 5.11-1.

Press **CPL** **SWP** and adjust the data with the  or  step keys.

The sweep time should be large (about 1000 seconds).

⑦ Set the marker on the screen to read the data, and correct the data with the correction factor corresponding to the quasi-power source circuit:

Press **MULTI MKR ON** and move the marker with the knob .

⑧ Cancel QP measurement mode (this sets REF mode).

Press **SHIFT** **EMC 1** **NORMAL** to cancel.

5.12 Date Function

Use the date function to set the year, month, date, and time for display. You can also change the date's display format. You can set the date to any day from January 1, 1989 to December 31, 2088 (leap years included). The date function automatically determines the day of the week. The time is displayed using the 24-hour system.

To use the date function, press SHIFT 2. The following menu appears.

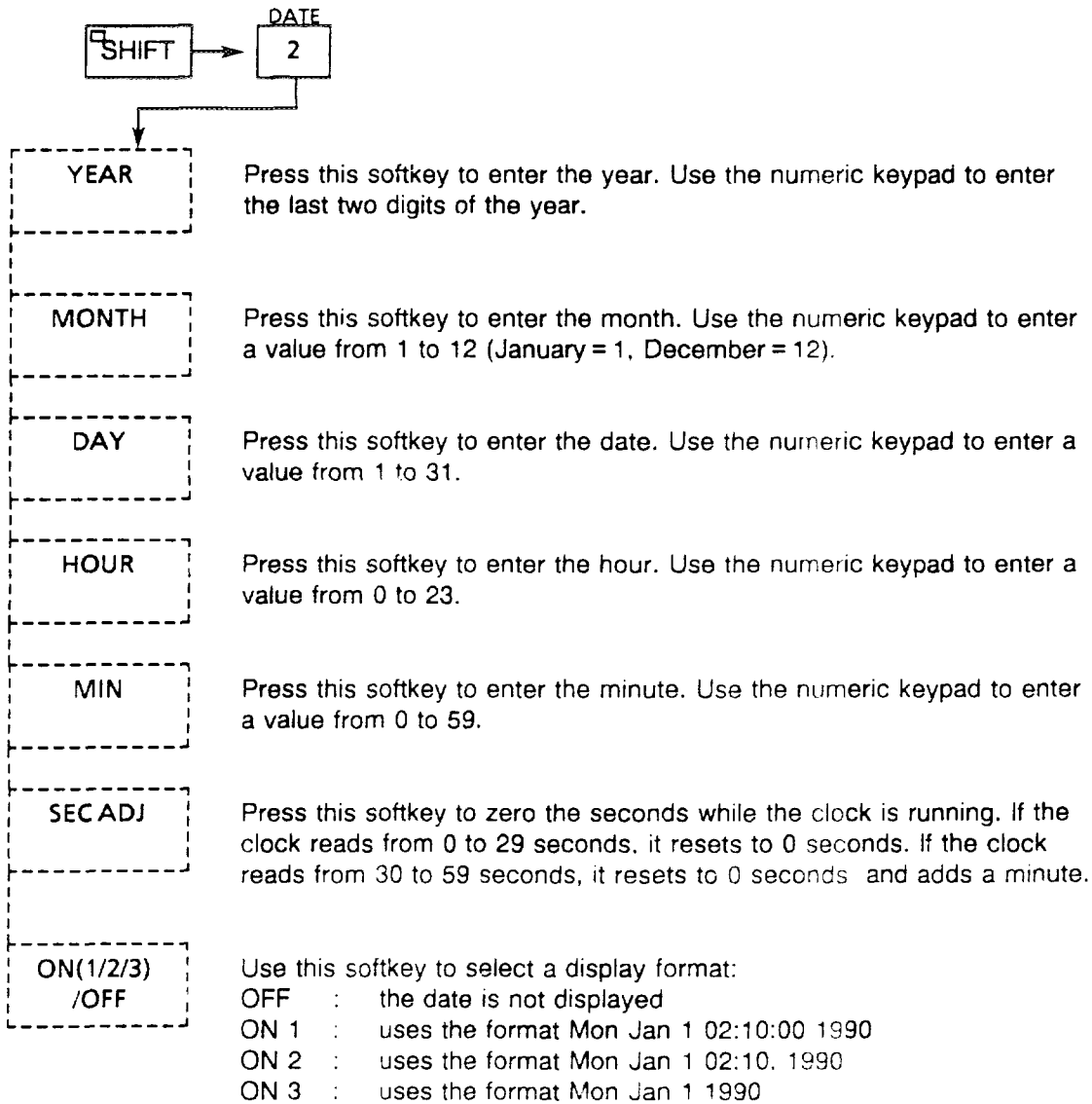

5.13 Utility Function

The utility function provides special features for making occupied bandwidth (OBW) and adjacent channel leak power (ADJ) measurements.

When making an OBW measurement, you center the signal of interest and enter the percentage of signal power you want to mark. The analyzer then marks the bandwidth within which that percentage of the signal lies. The delta marker shows the bandwidth value.

When making an adjacent channel leak power measurement, you specify a bandwidth and the spacing of communication channels within that bandwidth. When you then input a signal, the analyzer calculates the ratio of the power in the upper and lower channels to the total signal power. You can also display a graph to show leakage in all channels. The marker shows a quantitative value.

The procedure for these measurements is described in more detail in Chapter 4, Measurement Examples.

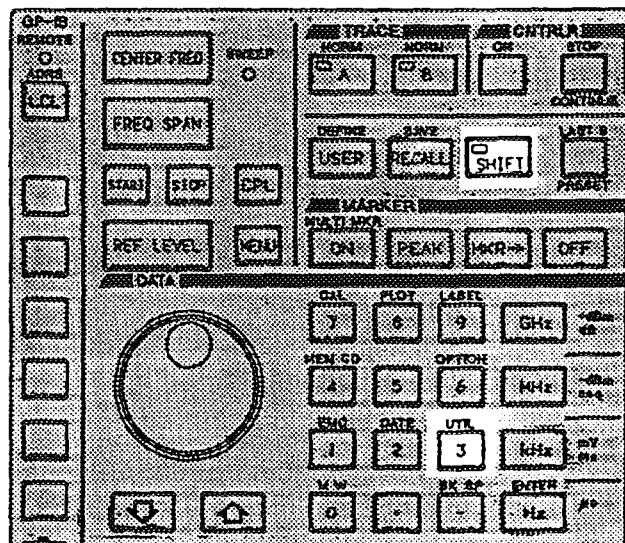

(1) OBW and ADJ Measurements

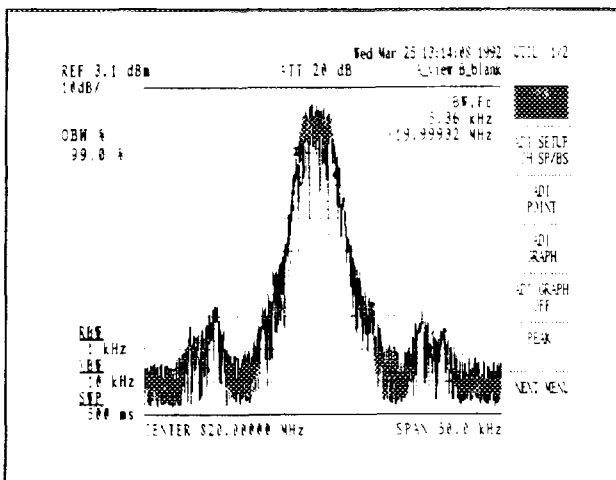

Figure 5.13-1 Waveform to Determine the OBW

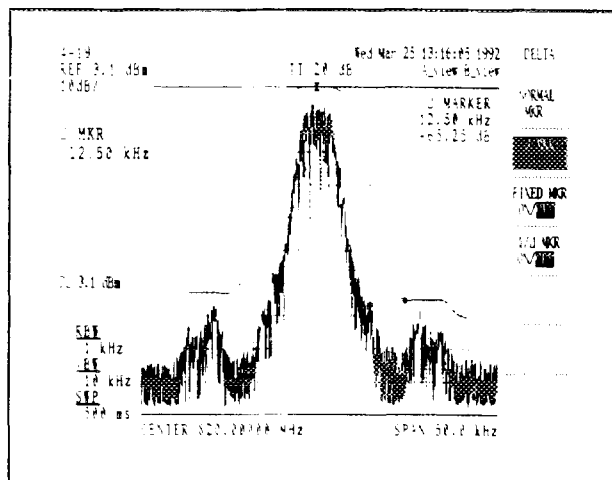
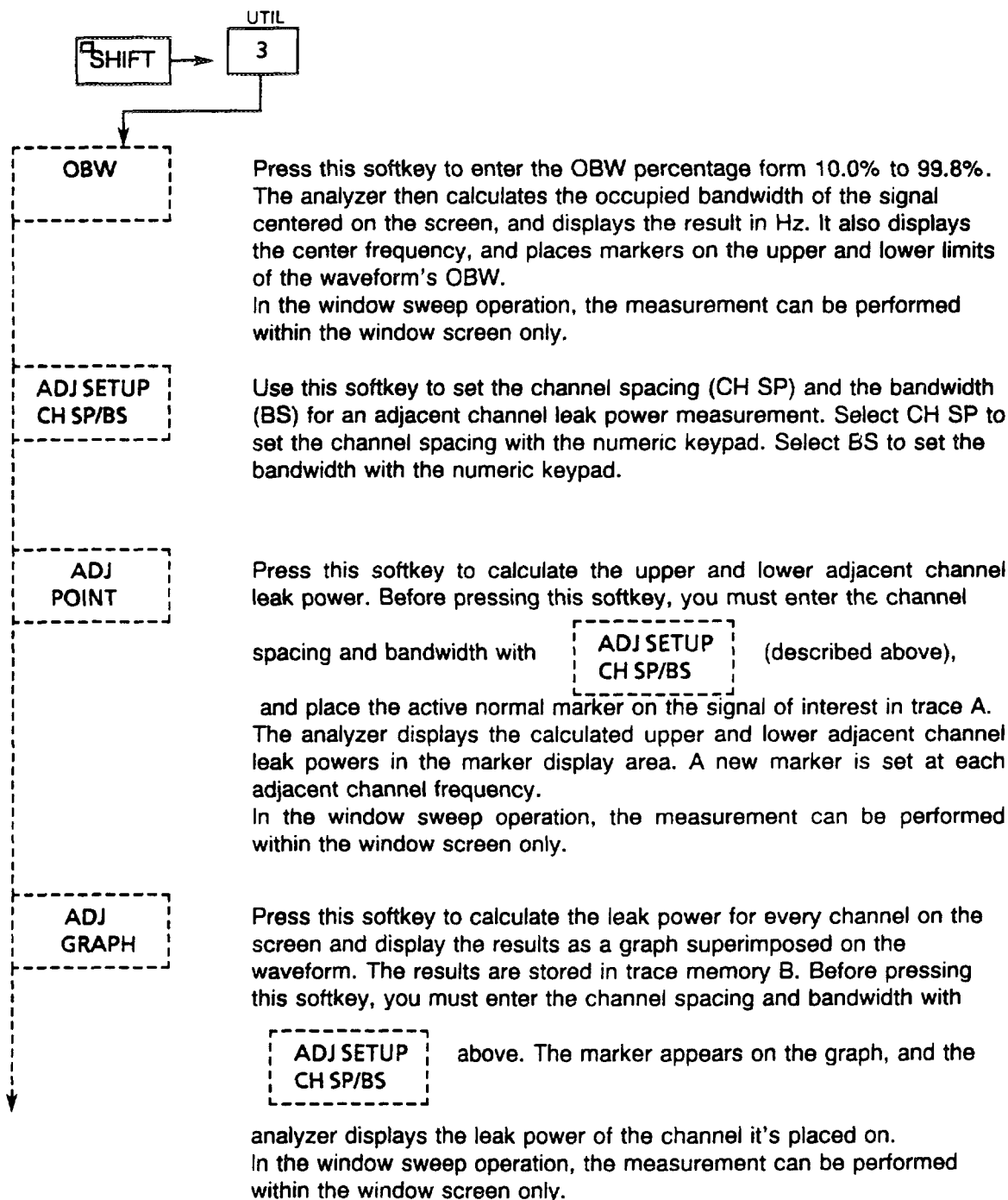
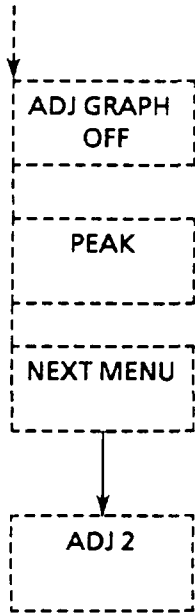

Figure 5.13-2 Adjacent Channel Leak Power in Graph

(2) Utility Menu

Press SHIFT 3 to open the utility menu.





Press this softkey to remove the ADJ GRAPH from the display.

Press this softkey to place the active marker on the signal peak. This is helpful for marking the carrier frequency signal before the ADJ POINT measurement.

Press this softkey to calculate the adjacent channel leak power of the centered signal two channels above and below the center frequency.

The analyzer's ADJ 2 calculation proceeds as follows: The analyzer assumes the center frequency is the carrier frequency, and determines the total signal power (PC) on the bandwidth you specified with

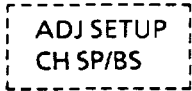

The analyzer then measures the power in the upper (PU) and lower (PL) adjacent channels. (The channel bandwidths are determined by the CH SP setting you made with

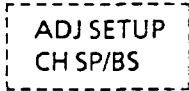

The analyzer calculates the ratios of PU to PC and PL to PC, and displays the results on the screen labeled UP and LOW. A marker appears at each channel frequency.

In the window sweep operation, the window width is calculated as a BS. (The BS that is set to ADT SETUP is not used.)

When starting the measurement, the window is automatically set at the center of the screen.

NOTE

1. Before pressing ADJ 2, you must center the carrier frequency, and enter the channel spacing and bandwidth with the ADJ SETUP softkey.
2. After the ADJ 2 calculation is complete, the span changes to three times the channel spacing.

5.14 Measurement Window Function

The measurement window function enables to perform the measurement, observing the wide span, within the specified area of the window width.

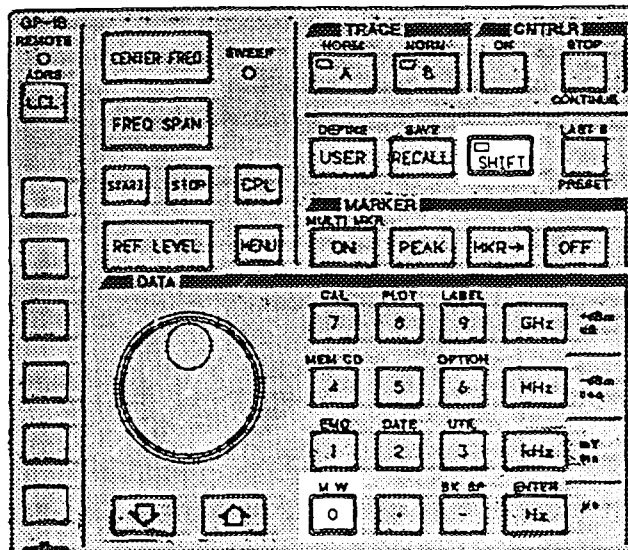

M W : Measure Window

(1) Measurement Window Menu

Press **SHIFT** **0** to open the measurement window menu.

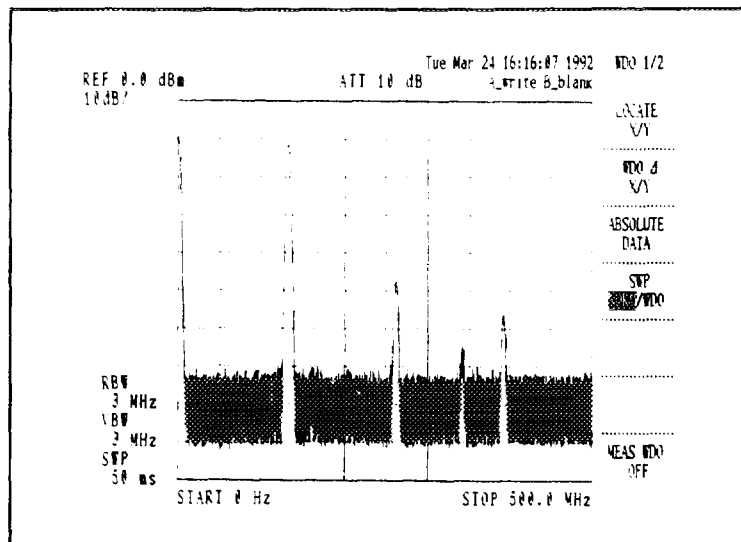
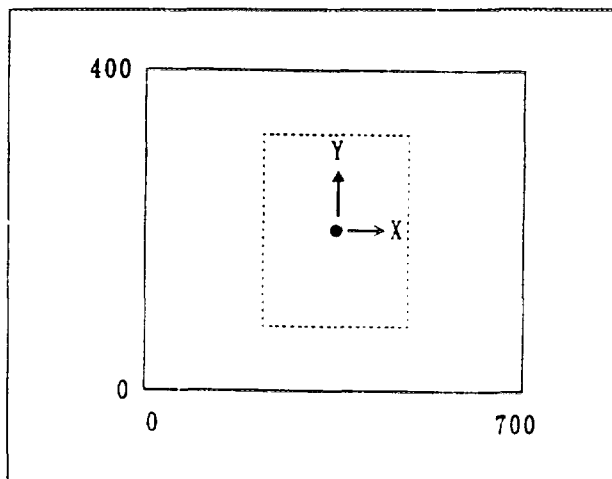

Figure 5.14-1 Initial Screen of the Measurement Window



LOCATE
X/Y

Press this softkey to set the X and Y coordinates of the window's center position using the step keys or the knob. The X coordinate must be from 0 to 700, and the Y coordinate must be from 0 to 400. (The center position (X) can be set using numeric keys.)



WD0 Δ
X/Y

Press this softkey to set the window's width (ΔX) and length (ΔY) using the step keys or the knob. (The X axis width can be set using numeric keys.)

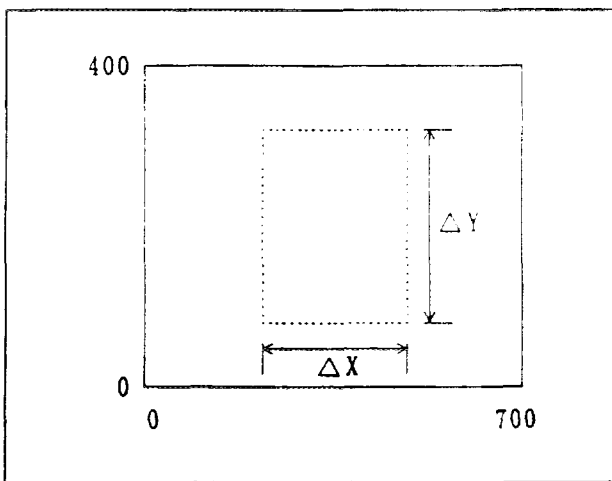

SWP
NORM/WD0

Use this softkey to turn sweeping within the window on and off. Select WD0 to sweep within the window. Select NORM to sweep over the entire span.

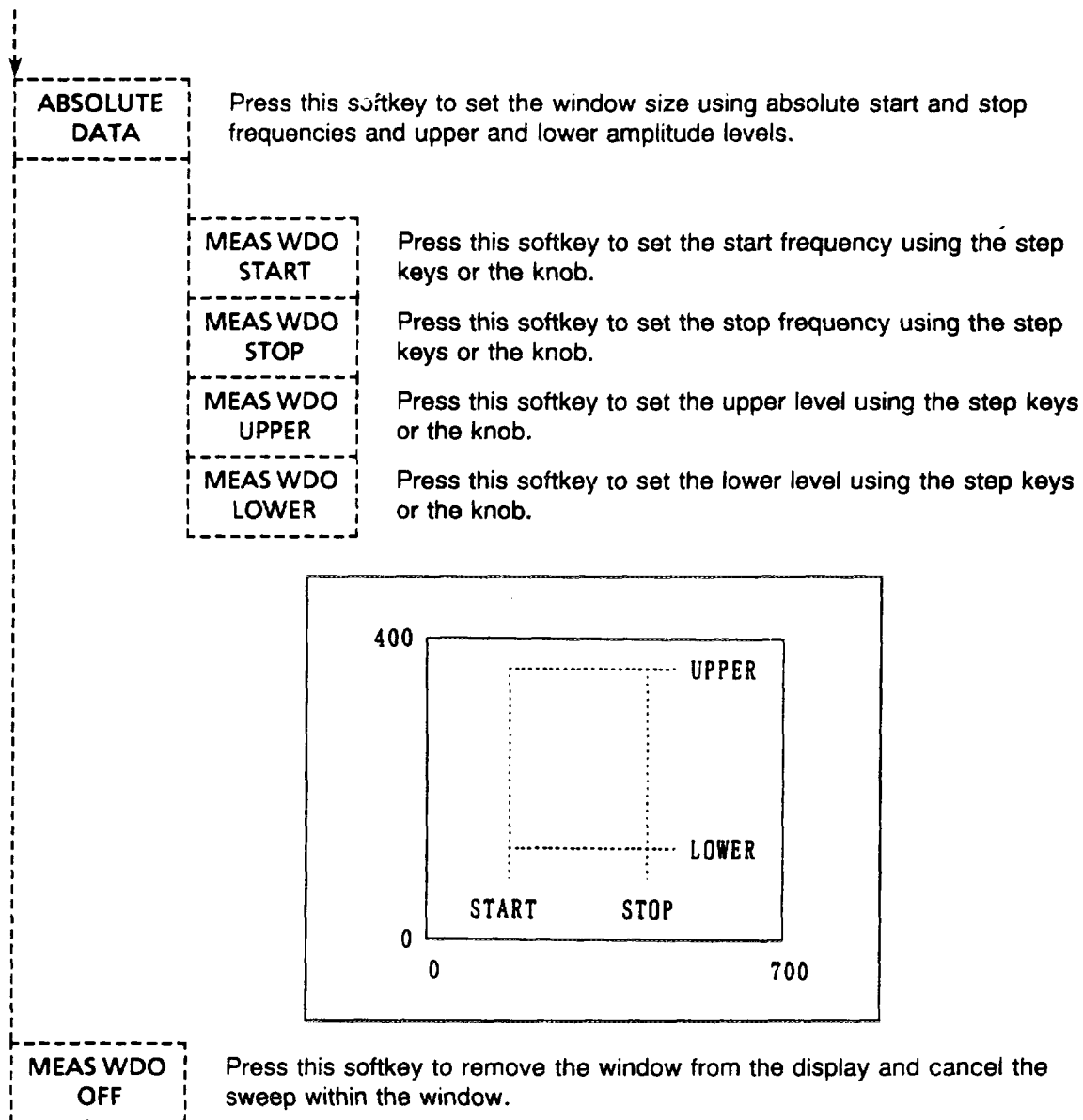

(2) Measurement Example of Displaying the Window

Opening the window (ON is selected) enables to limit the area to be measured within the window only for the sweep operation and the marker function, and also enables to shorten the measurement time (sweep time) or define the search area.

(Marker)

① Window Sweep

There are two ways to set the analyzer to sweep within a window.

Press **SHIFT** **MW** **0** and **SWP NORM/MDO** to select MDO.

Cancel this function by setting MDO to NORM.

Alternatively, you can press the following keys:

Press **MENU** **SWEEP MODE** **WINDOW SWP**.

Cancel this function by pressing **CONT SWP**.

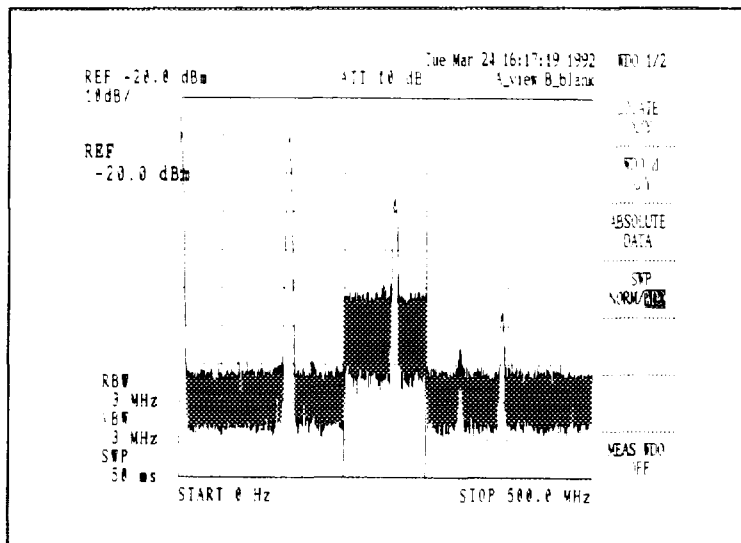

Figure 5.14-2 Partial Sweep Within a Window

② Peak Search within Window

Same as MIN search and continuous peak search

③ NEXT Peak Search within Window

Same as RIGHT, LEFT, MAX/MIN, and MIN

④ X dB down within Window

Same as LEFT, RIGHT and continuous down

⑤ Power Measurement

Calculates the measurement value of the average power and the total power within the window waveform only.

⑥ Utility Function

Enables to perform the measurements such as OBW, ADJ point, and ADJ graph, and ADJ 2. (only when window sweep)

⑦ GO/NG Judgment (GPIB control only)

Enables to display the window and judge the upper or lower limit value of UPPER or LOWER level within the range of the window start/stop frequency.

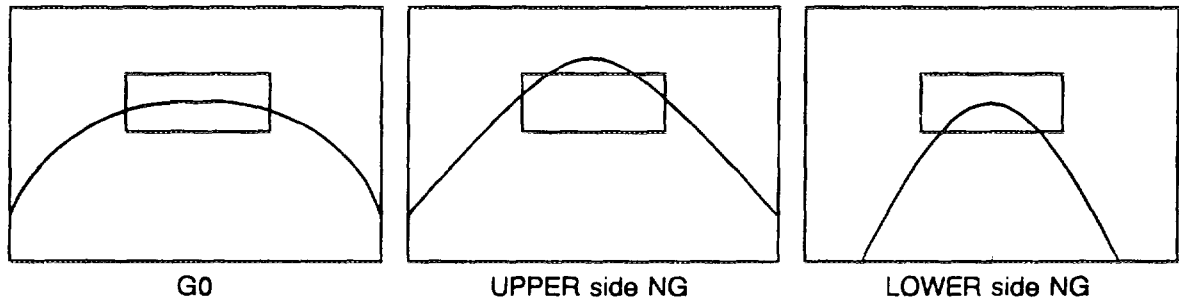

GPIB command	Contents
CMA	Judges the trace A.
CMB	Judges the trace B.
CM?	Read out judgment result When result = GO : 1 When result = NG : 0

5.15 Printer Output

The R3265A/3271A analyzer can output the screen display to the printer.

Table 5.15-1 Usable Printer

Maker	Printer
Hewlett-Packard, Co.	HP2225AJ

(1) Connecting to printer

The R3265A/3271A and the printer are connected using a GPIB cable between each GPIB connector.

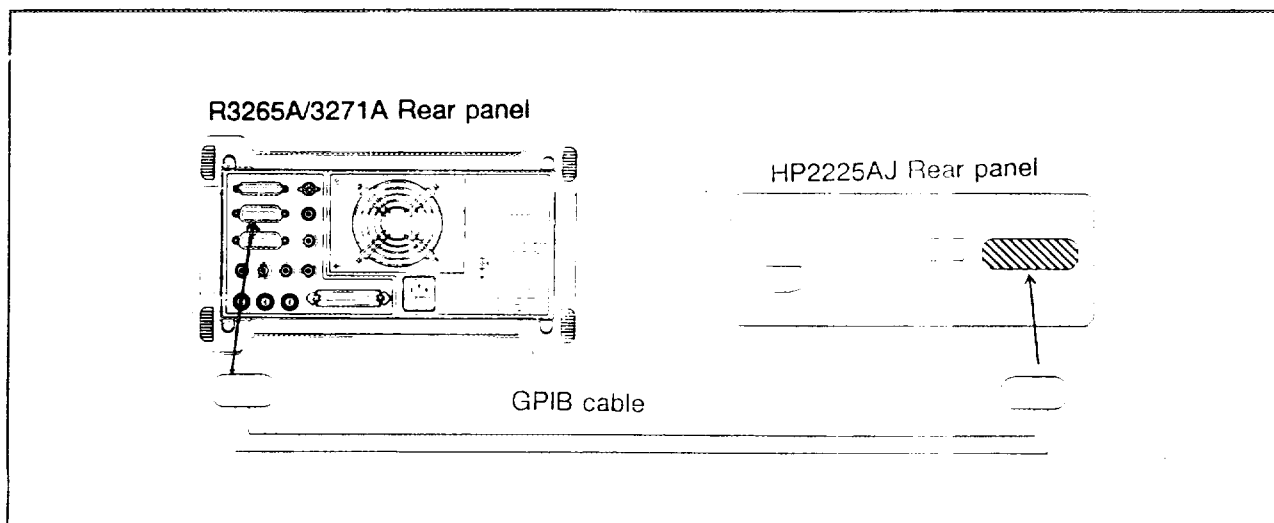

Figure 5.15-1 R3265A/3271A and Printer Connection Diagram

(2) Printer address setting

The printer address should be set using the DIP switch. The printer address for the R3265A/3271A side is set from the soft menu.

The address setting is shown in Figure 5.15-2.

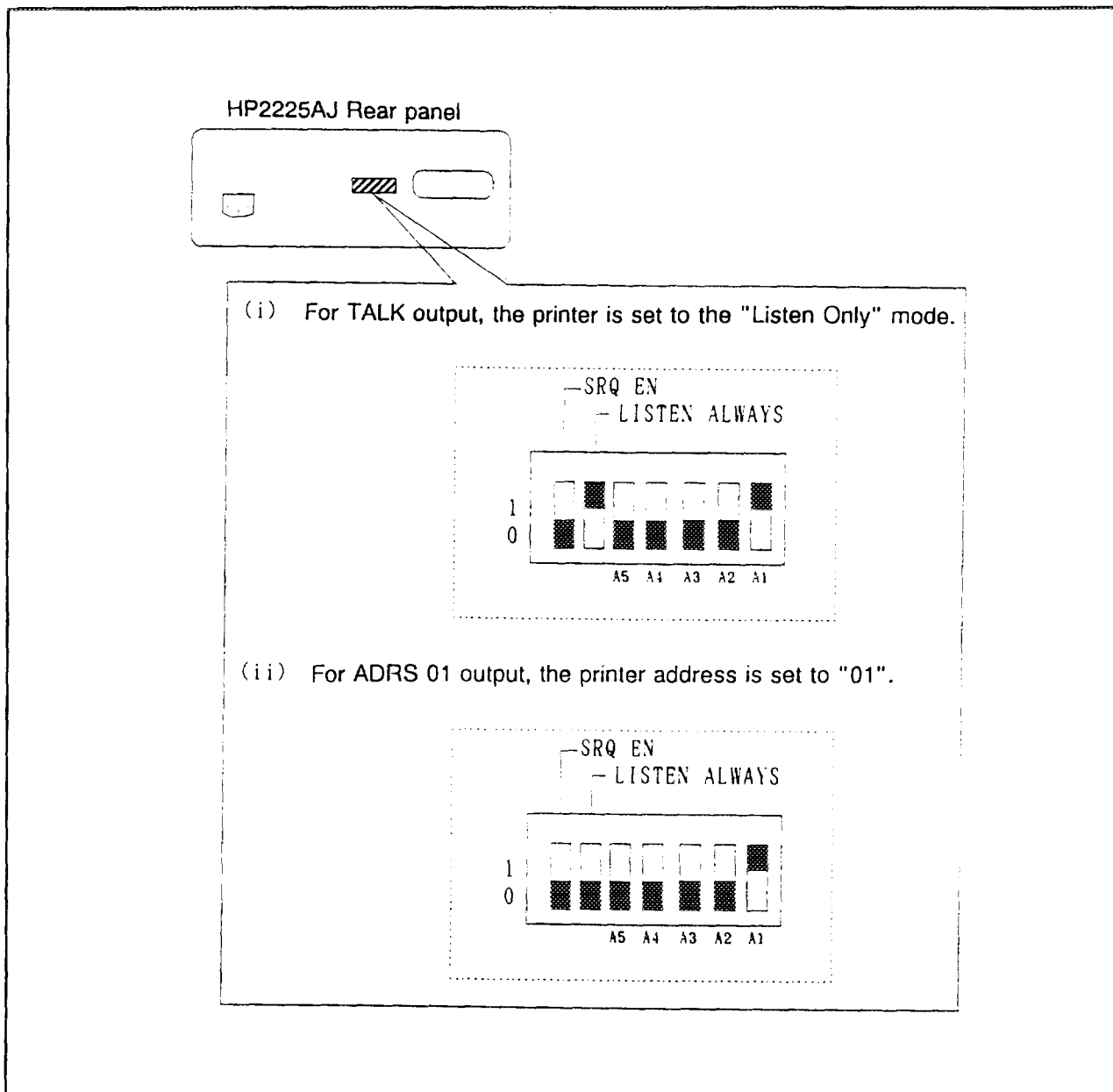
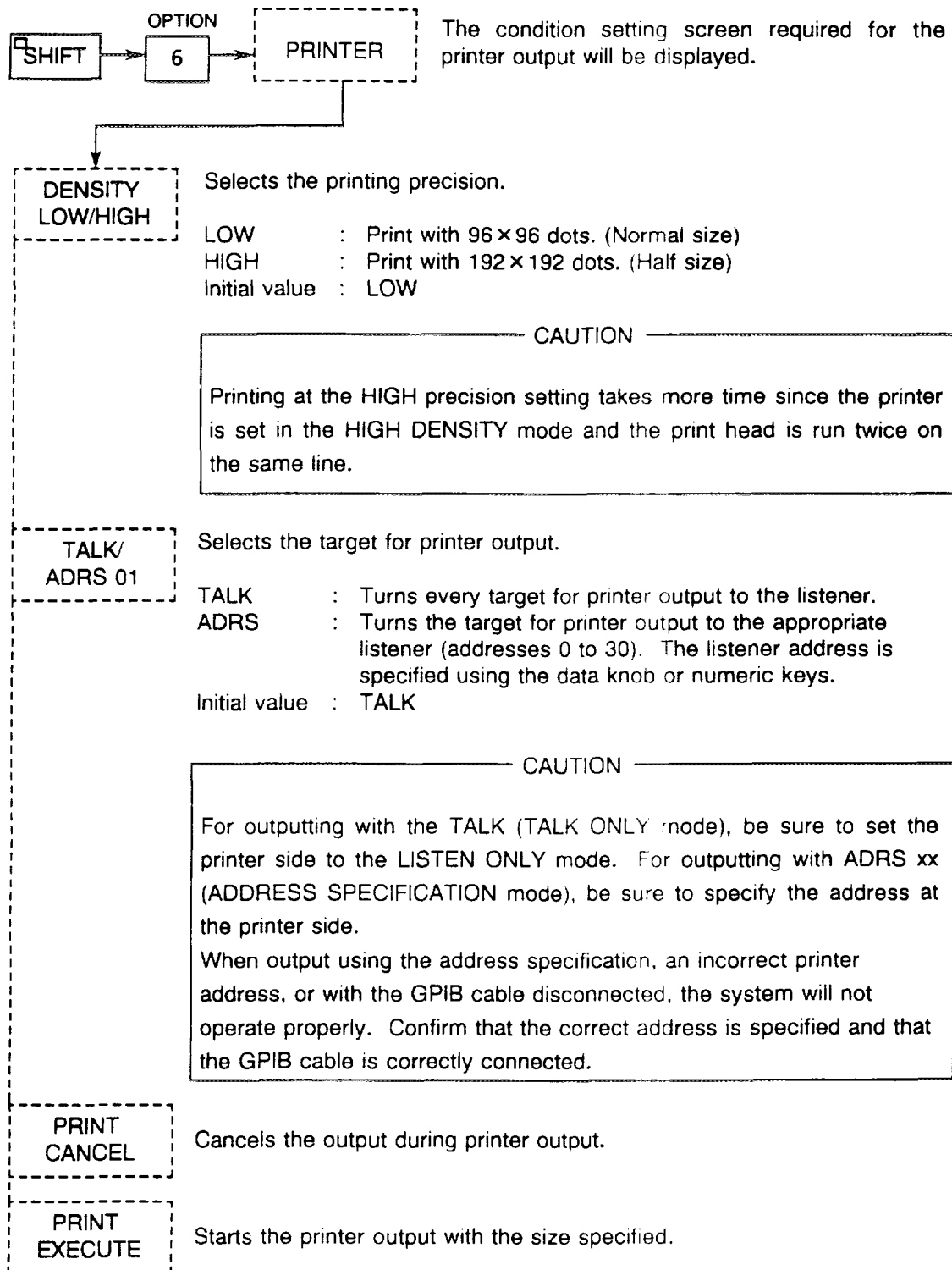

Figure 5.15-2 DIP Switch for Address Setting

CAUTION

1. For details of the GPIB, refer to sections 6.1 and 6.2.
2. The printer operation is explained in the printer instruction manual.

(3) Output setting menu for printer



(4) Example of printer output

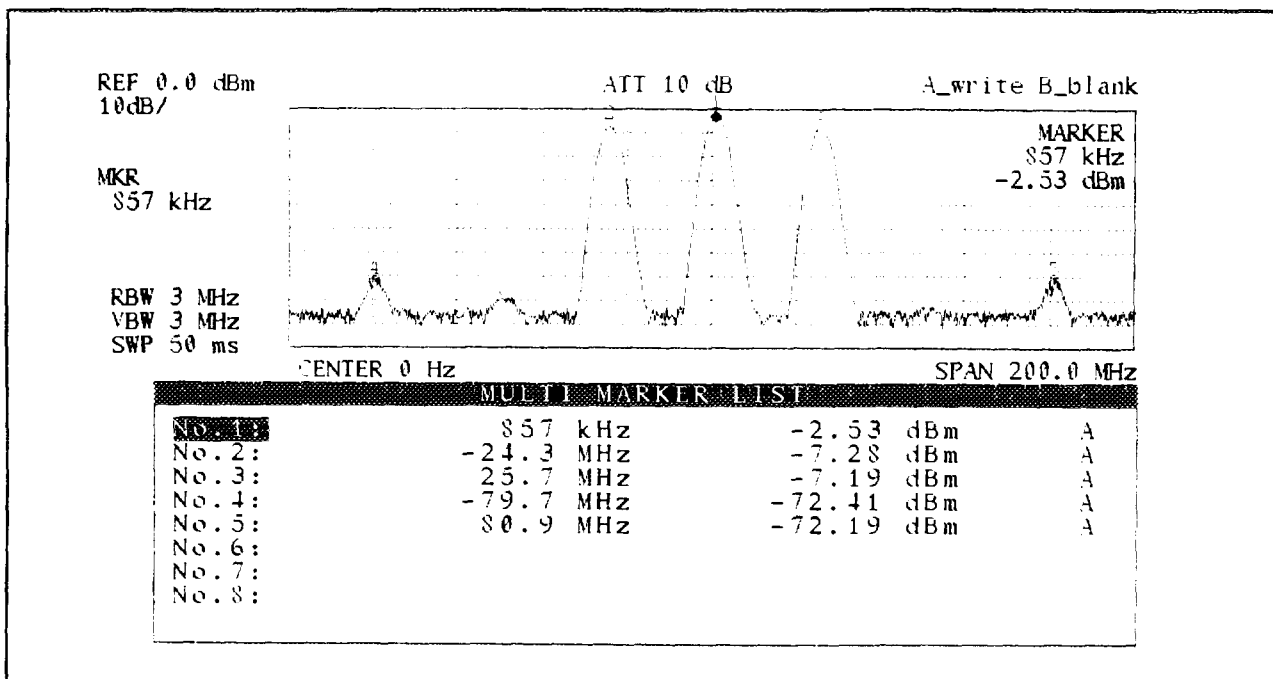

Figure 5.15-3 Printing Precision Set at LOW (Normal Size)

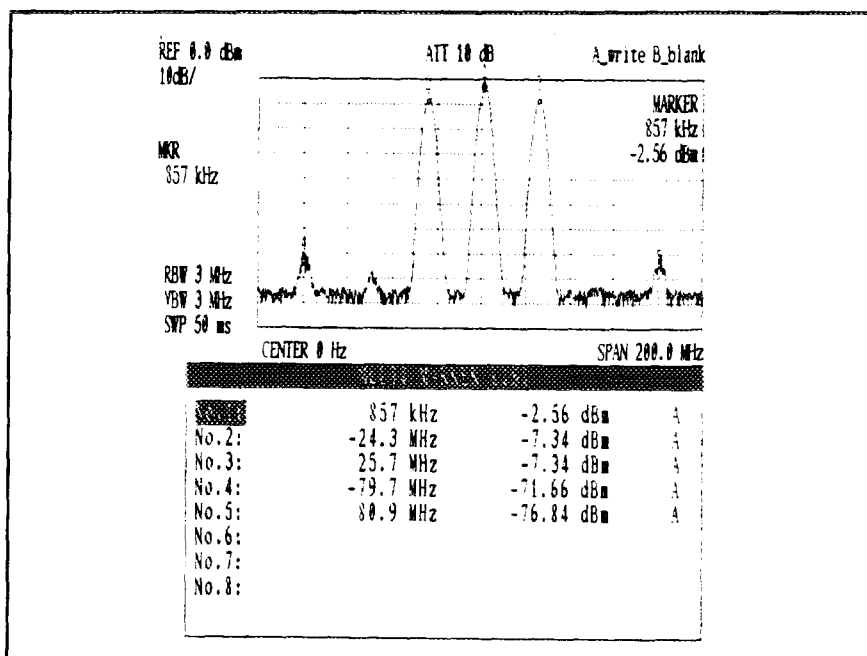

Figure 5.15-4 Printing Precision Set at HIGH (Half Size)

5.16 Power Measurement Functions

Measurement of power of this unit includes the following functions:

- Measurement of average power (AVG. POWER)
- Measurement of average power density (dBm/Hz)
- Measurement of total power (TOTAL POWER)

(1) Measurement of average power

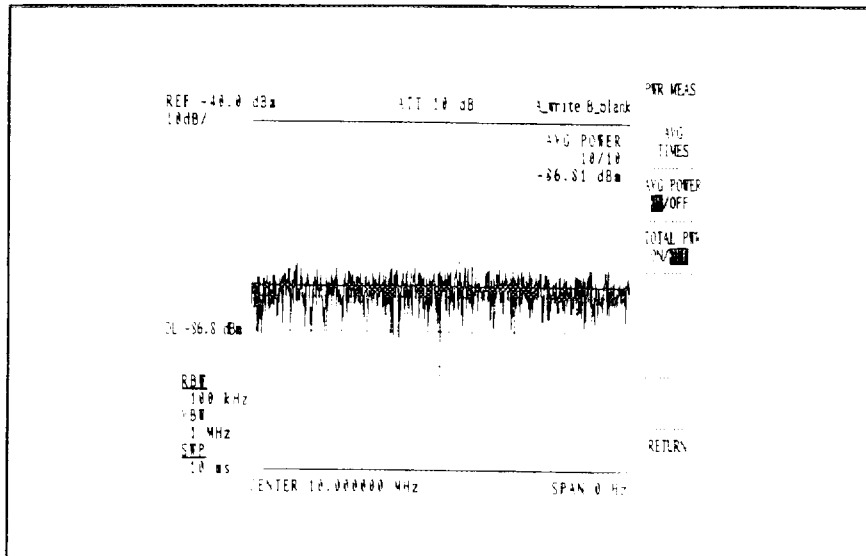

Figure 5.16-1 Average Power Measurement

The average power measurement is used to calculate the average power value for the signal displayed on the screen.

When the vertical axis represents LOG, all of the signal point data are converted into truth power dimension values to calculate the average.

When the Resolution Band Width (RBW) is much wider than the signal band width at 0 span (fixed receive), the average power can be measured accurately, even if the signal includes an AM factor.

(2) Measurement of average power density

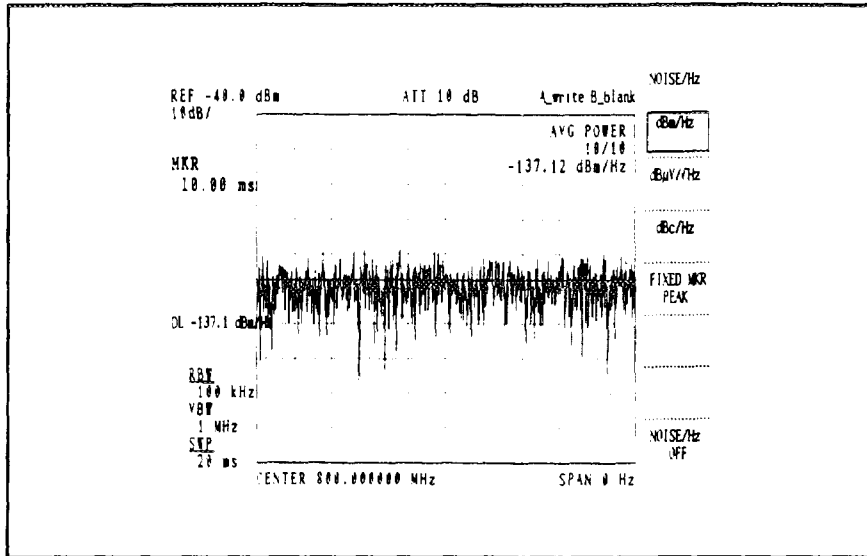

Figure 5.16-2 Average Power Density Measurement

The average power density measurement is used to calculate the power density in the specified bandwidth for the power measurement of wide band modulation waveforms such as noise or spectrum diffusion.

- To measure the average power density, turn the average power measurement mode to ON to execute the dBm/X Hz in the marker menu. Measurement is performed by entering the specified band width into X.

(3) Measuring total power

Total power measurement enables the total power of the signals which are displayed on the screen to be calculated and the power value of the wide band range modulation wave to be measured.

In the wide band range modulation wave, the display amplitude of the spectrum analyzer varies according to the setting of the resolution band range width (RBW). However, since the RBW is compensated by using this function, the total power can be measured.

CAUTION

Use this function after executing the PBW calibration of the R3265/3271.

Key operation for PBW calibration



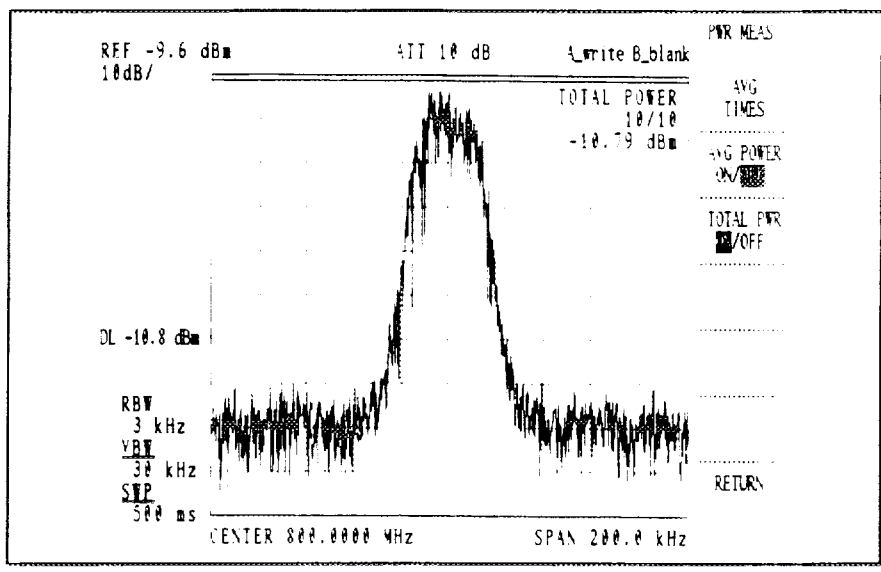

(4) Menu for power measurement function

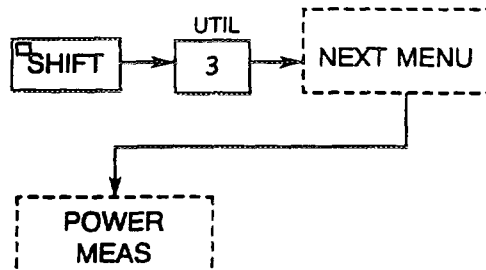

AVG TIMES	Sets the value of average number of times. The average number of times can be set in the range of 1 to 1000.
AVG POWER ON/OFF	The average power measurement mode is started by turning the AVE POWER on. The number of count and the average power value are displayed on the upper right of the screen whenever the sweep is completed. The display line is displayed in the level corresponding to the average power value. The measurement mode is ended by turning the AVG POWER off.
TOTAL PWR ON/OFF	When ON is selected, the total power measurement mode starts. The number of counts and the total power value are displayed on the upper right of the screen whenever the sweep is completed. The display line is displayed in the level corresponding to the average electric power value. The measurement mode will be completed when it is turned off.

- In power measurement, if the measuring window is turned on, measurement is performed in the frequency range of the window.
- After the average time has been completed (e.g. 10/10), the movement average mode is set and the measurement continues.
- If a frequency, level, average number of times, or window setting is changed during the measurement, the count will be reset and the measurement will be re-executed from the beginning.
- If the VBW is set to AUTO during the measurement, $VBW = RBW \times 10$ will be set automatically. Also, the trace DET will be switched to the sample mode.

(5) Measurement procedure

- ① Set the average number of times to 10 and turn the average power measurement mode on.

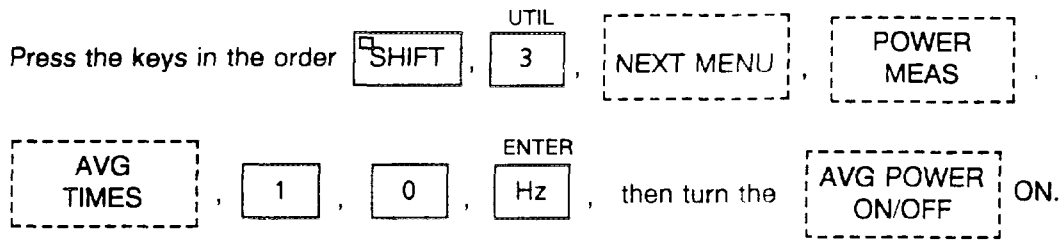

- ② The average power measurement can also be used to measure the (a) or (b).

- (a) Measurement of the average power in the window
- (b) Measurement of the average power density with the dBm/Hz of the marker on

- (a) After turning the average power measurement mode on in procedure ①, set the measuring window to ON.

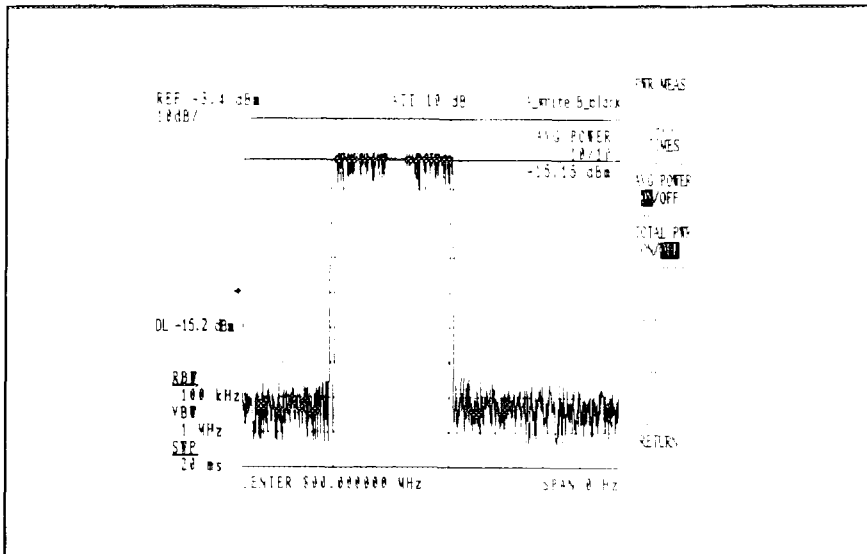
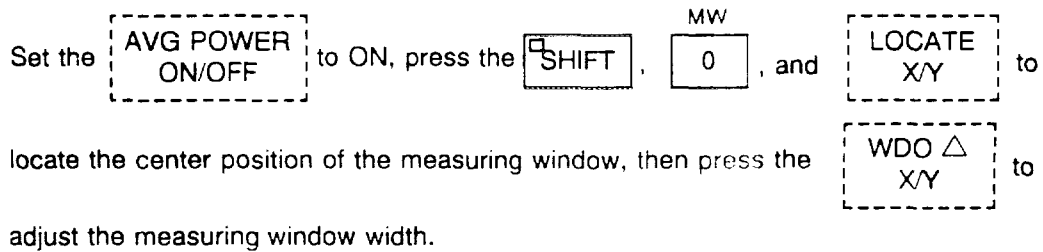

Figure 5.16-3 Average Power Measurement in Measuring Window

- (b) After turning the average power measurement mode on in procedure ①, set the dBm/Hz of the marker to ON.

Set the AVG POWER
ON/OFF to ON, then press ON, NOISE/
X Hz, and dBm/Hz.

- ③ Set the average number of times to 10, then turn the average power measurement mode on.

Press the keys in the order SHIFT, UTIL
3, NEXT MENU POWER
MEAS

AVG
TIMES 1 0 ENTER
Hz then turn the TOTAL PWR
ON/OFF on.

- Measurement of the total power in the measuring window.

After turning the total power measurement mode on shown in the above operation, set the window to ON.

Set the TOTAL PWR
ON/OFF to ON, press the SHIFT, MW
0, and LOCATE
X/Y to

locate the center position for the measuring window, then press the WDO Δ
X/Y to

adjust the measuring window width.

(6) GPIB remote programming

GPIB command	Contents
PWTM PWTM?	Setting of AVG times (1 to 1000 times) Read out data of AVG times.
PWAVG ON PWAVG OFF PWAVG?	AVG POWER ON AVG POWER OFF Read out AVG POWER measurement data.
PWTOTAL ON PWTOTAL OFF PWTOTAL?	TOTAL POWER ON TOTAL POWER OFF Read out TOTAL POWER measurement data.
HD0 HD1	Header OFF Header ON (at execution of PWAVG? or PWTOTAL?) PWB ← at dBm PWM ← at dBmV PWU ← at dBuV PWE ← at dBuVermf PWP ← at dBpW PWV ← at Volt PWW ← at Watt

Read out the measurement data when the SRQ signal of SWEEP END is generated. However, it is necessary to read out the data after the SWEEP reaches the AVG times (e.g. 5/5). (At this time, the SRQ of AVG END is generated.)

- Status byte (S)

bit 7 6 5 4 3 2 1 0

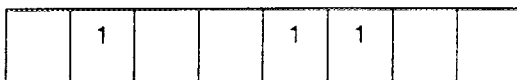

S = 68 (SWEEP END, SRQ ON)
S = 72 (AVG END, SRQ ON)

bit2 = SWEEP END (S = 4)
bit3 = AVG END (S = 8)
bit6 = SRQ ON (S = 64)

- Counter display (in SWEEP END)

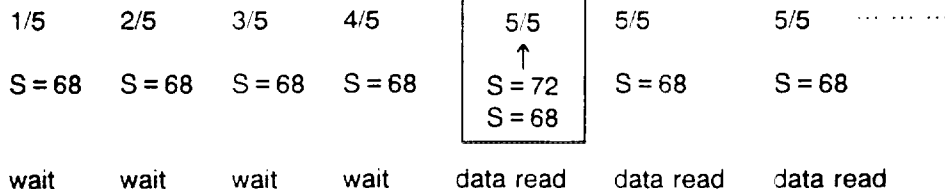

While the average power (AVG POWER) or total power (TOTAL POWER) is being measured, take care to reset the AVG times when the CENTER, SPAN, REF LEVEL, window, or other settings have been changed.

Example: Measure AVG POWER in window to read data.

Example of programming for HP300 series (GPIB address = 8)

```

10     Aend=0
20     OUTPUT 708;"S0"
30     OUTPUT 708;"CF100MZ SP10MZ"
40     OUTPUT 708;"WDX5MZ WLX100MZ"
50     OUTPUT 708;"HDO PWAvg?"
60     OUTPUT 708;"PWTM 5ENT"
70     OUTPUT 708;"PWAvg ON"
80     ON INTR 7 GOTO Srqint
90     Wloop:|
100    ENABLE INTR 7;2
110    GOTO Wloop
120    |
130    Srqint:|
140    S=SPOLL(708)
150    IF BIT(S,3)=1 THEN Aend=1
160    IF BIT(S,2)=1 THEN GOSUB Avgout
170    GOTO Wloop
180    |
190    Avgout:|
200    IF Aend=0 THEN RETURN
210    ENTER 708;A
220    PRINT A
230    RETURN
240    |
250    END

```

Explanation of program

```

10     Clear AVG END flag.
20     Set to SRQ interrupt output mode.
30     Center frequency=100MHz, span=10MHz
40     Window width=5MHz, window center=100MHz
50     Specify header OFF and output data to AVG data.
60     Set AVG time to 5times
70     AVG POWER ON
80     Specify position to jump on occurrence of SRQ interrupt.
90     Wait for SRQ interrupt (loop).
130    Jump with SRQ interrupt.
140    Execute serial pole.
150    Turn AVG END flag ON if AVG END (bit 3=1).
160    Read out data if SWEEP END (bit 2=1).
210    Read AVG data.

```

- When measuring the average power density, change the 50th line as follows:

```
50      OUTPUT 708;"H00 NI 1Hz,NIM,ML?"
```

Explanation of program

```
50      Turn header OFF, dBm/Hz ON, and specify output data to marker level
```

- When measuring the total power, change the 50th and 70th line as follows:

```
50      OUTPUT 708;"H00 PWTOTAL?"  
70      OUTPUT 708;"PWTOTAL ON"
```

Explanation of program

```
50      Specify header OFF and output data to TOTAL POWER data.  
70      TOTAL POWER ON
```

5.17 Tracking Generator Functions (R3365A/3371A only)

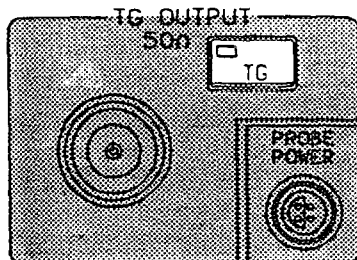

TG

Press this key to set the amplitude-measurement mode using the tracking generator, and open the tracking generator menu screen. In this case, the amplitude measurement mode or the power sweep mode was already set, execute to only display the menu screen.

TG

MAG

Press this key to set the amplitude measurement mode using the tracking generator.

OUTPUT LEVEL

Press this key to execute the setting mode for TG output level. The TG output level is available for the range "0 dB to -30 dB".

PREV MENU

Return to the previous menu.

TG

POWER SWEEP

Press this key to set the power sweep mode using the tracking generator.

START LEVEL

or START

Press this key to set the start level for power sweep is available for the range "0 dB to -30 dB".

STOP LEVEL

or STOP

Press this key to set the stop level for power sweep is available for the range "0 dB to -30 dB".

SWEEP TIME	Press this key to set the SWEEP TIME is available for the range "200ms to 1000s".
SMOOTHING ON/OFF	Use this key to execute the smoothing for input signal synchronizing with sweep. The count of smoothing is available for "2 to 100". In this case, SWEEP TIME is automatically set the suitable value.
REF. LINE	Press this key to display the menu screen for setting the reference line.
The reference is a standard line to compare the level for power sweep waveform.	
REF. LINE ON/OFF	Use this key to display/delete the reference line.
X/Y dB	Press this key to set the slope of reference. The setting value is a vertical axis ratio to horizontal axis. The initial value is "1".
OFFSET	Press this key to set the vertical OFFSET of reference line. The OFFSET is available for the range " - 100 dB to + 100 dB". The initial value is "0".
PREV MENU	Return to the previous menu.
PxdB MKR	Press this key to display the menu for setting PxdB MKR.
PxdB MKR EXECUTE	Press this key to display the Marker under X dB from the reference line.
PxdB CONT ON/OFF	Set this key to ON to execute the PxdB MKR each sweep.

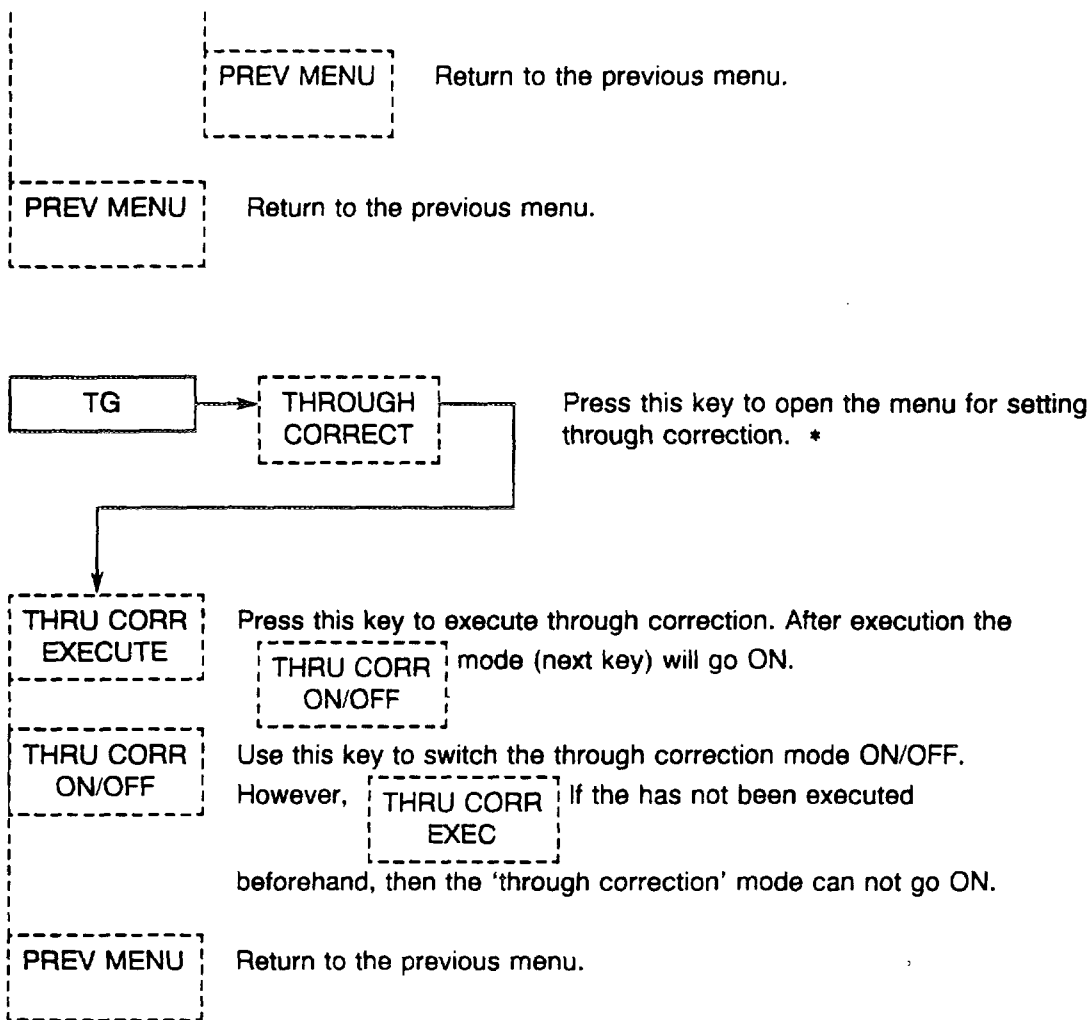

* : This normalizes over the full frequency range of the Tracking Generator. Therefore after this normalization any changes to the span frequency, center frequency, and reference level will not mean that a further normalization is necessary.

5.17 Tracking Generator Functions (R3365A/3371A only)

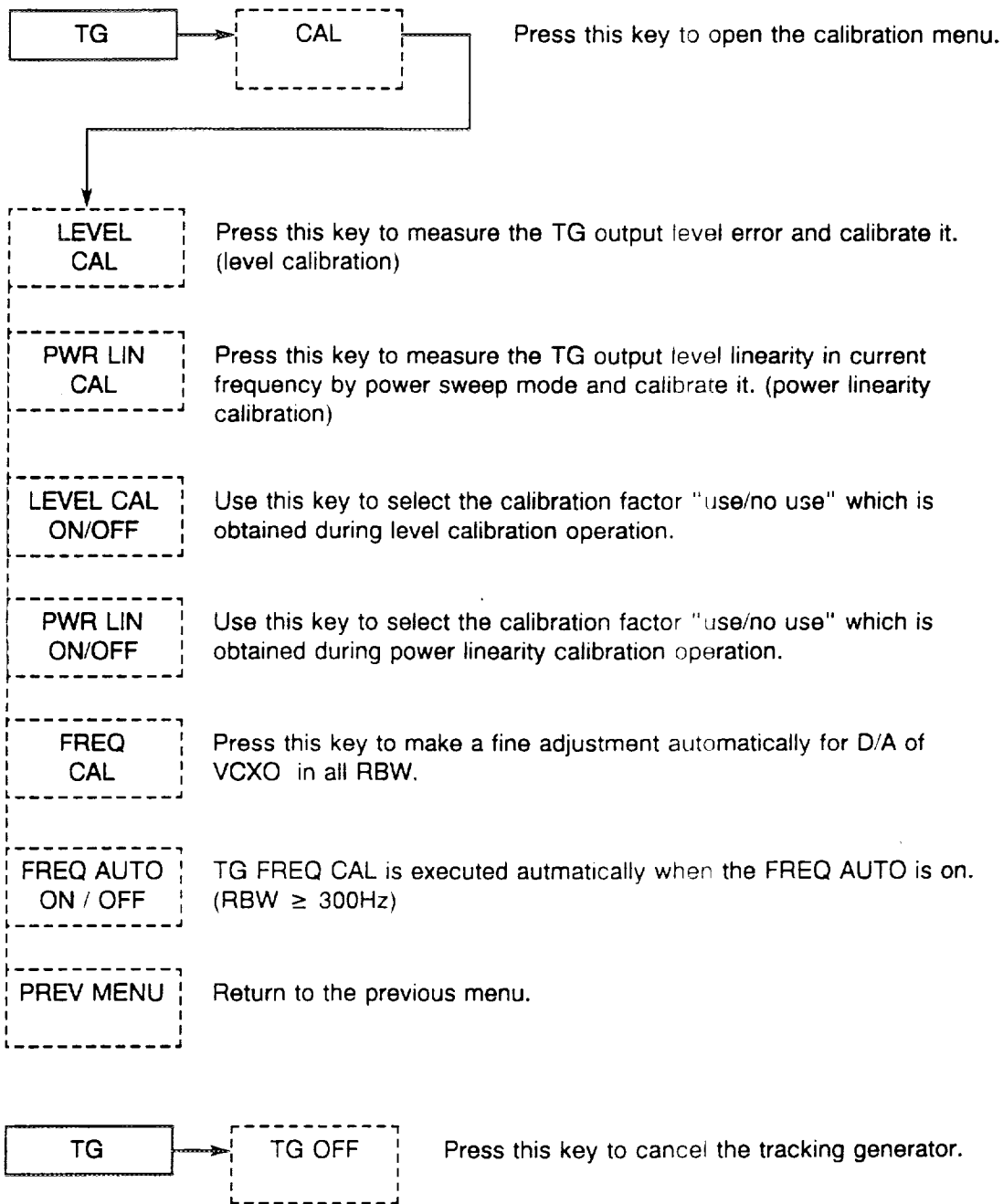

CAUTION

Before using the calibration function, let the analyzer warm up for at least 60 minutes.

5.18 Serial I/O Function

A controller such as a personal computer having no GPIB interface can also offer a simple measurement system, using the serial I/O function (RS-232C interface).

Remote control which is normally carried out, using the GPIB interface, can also be obtained, using the serial I/O function (RS-232C interface).

(1) Compatibility with the GPIB remote control codes:

The control codes which can be used by the serial I/O function are identical to the GPIB codes of the R3265A/3271A, excluding some of the codes/functions inherent to the GPIB.

CAUTION

1. See the R3265A/3271A Instruction Manual (Section 6.8 GPIB Code List).
 - Talker/Listener codes can be used as they are.
 - Header information related to the Talker request is compatible.
 - The output format is also compatible.
2. See Subsection 5.18.5 of this manual "Difference from the GPIB Remote Programming".
 - Different from the R3265A/3271A GPIB codes in some points.

(2) Functions which can externally be controlled

The following functions can be controlled with the serial I/O:

- ① Measurement condition setting: Conditions entry through panel key operation
- ② Set states output: Set states and data call
- ③ I/O of measurement data: Screen trace data write-in and read-out
- ④ Status output: Data on the current instrument status can be read output in the same way as the GPIB status byte.

5.18.1 Specifications

(1) Transfer speed (baud rate): The following six speed modes can be selected.

- ① 19200 bps
- ② **9600 ←Default**
- ③ 4800
- ④ 2400
- ⑤ 1200
- ⑥ 600

(2) Data length: The following two modes can be selected.

- ① **7-bit ←Default**
- ② 8-bit

(3) Stop bit : The following three modes can be selected.

- ① **1 bit ←Default**
- ② 1.5 bit
- ③ 2 bit

(4) Parity bit: The following three modes can be selected.

- ① **None ←Default**
- ② Odd parity
- ③ Even parity

(5) Communication: Semi-double type

- (6) **Data flow control:** The handshake type of the communication with the controller is specified. The following two modes can be selected according to the controller communication port function.
- ① **Hard Wired handshake** ←Default
The RS-232C transmits no data while the transmitter DSR line is kept low. While the R3265A/3271A DTR line is kept low, no transmission data is accepted.
 - ② **Xon/Xoff handshake**
Once the Xoff character is received through the data line, the transmitter transmits no data until the Xon character is received. In case the R3265A/3271A cannot receive a data, the Xoff character is transmitted to indicate that no data can be accepted. When the R3265A/3271A has become capable of receiving data, the Xon character is promptly transmitted.
- (7) **Characters between transmitting interval:** When transmitting data from the R3265A/3271A, a time interval can be set between characters so as to reduce the load at the controller. The following five modes can be selected.
- ① **0** ←Default
 - ② 1.0 milli sec.
 - ③ 2.5 milli sec.
 - ④ 4.0 milli sec.
 - ⑤ 5.5 milli sec.
- (8) **Communication procedure:** The communication is of non-protocol type, using carriage return (CR) and line feed (LF) as the message delimiters.
Note: A special method is used for binary output of waveform data. (See Subsection 5.18.4 "Extended Format".)
- (9) **Transfer error control:** No transfer error control is executed in the R3265A/3271A. If necessary, carry out the control with the controller.

(10) Communication port opening:

The R3265A/3271A ports are opened when power is turned ON. The parameters required for communication are held in memory. The port is opened with the values which have been set through the panel/soft key operation. When shipped from the factory, the values are set to the default.

The communication port can forcibly be closed through the panel/soft key operation.

5.18.2 Connection

(1) Connection with the Controller

Use the RS-232C cable for connecting the R3265A/3271A with the controller.

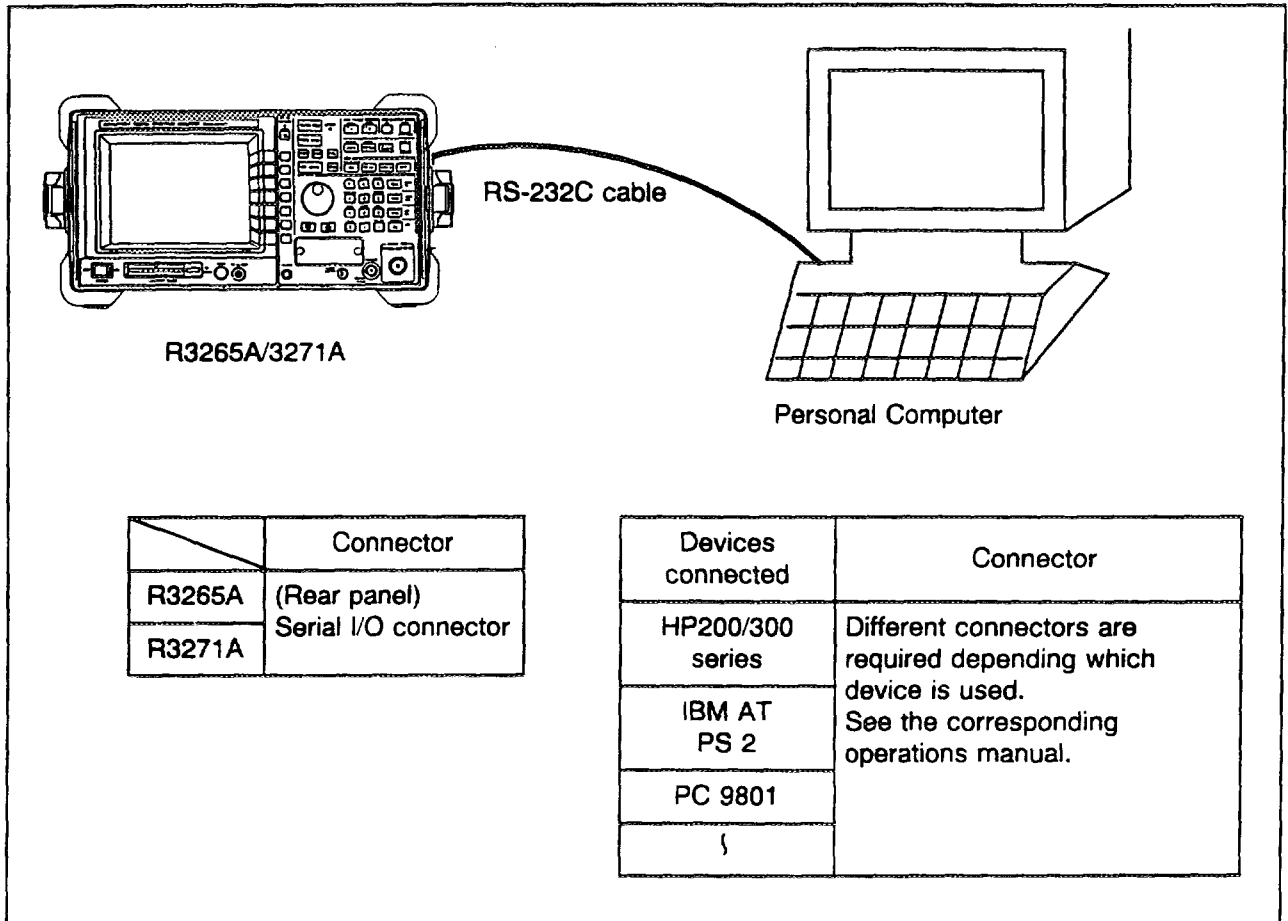

Figure 5.18-1 Personal Computer Connection

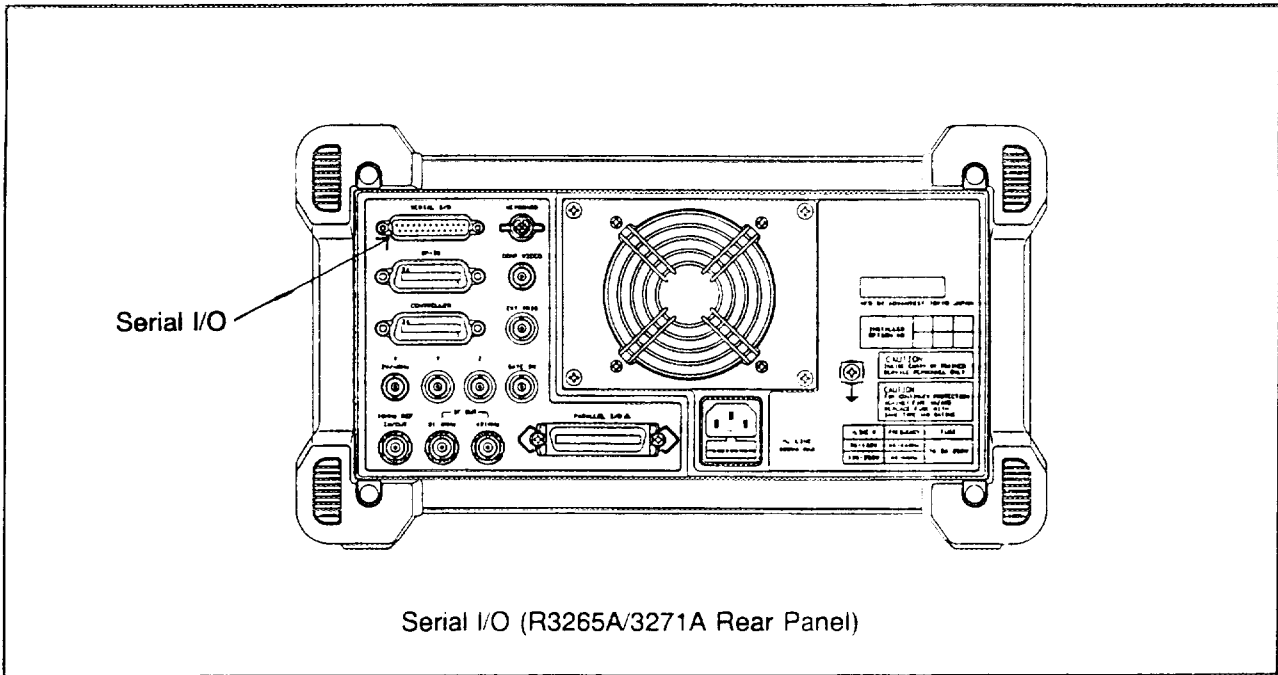

Figure 5.18-2 RS-232C Communication Port

This section describes the connection with the controller (such as a personal computer) for using the serial I/O. The signal lines here are named according to the EIA (Electric Industries Association).

<u>R3265A/3271A (25-pin D-SUB)</u>			<u>Host (25-pin D-SUB)</u>	
Pin No.	Signal name		Signal name	Pin No.
2	BA (TXD)	→	(RXD) BB	3
3	BB (RXD)	←	(TXD) BA	2
4	CA (RTS)	→	(DCD) CF	8
8	CF (DCD)	←	(RTS) CA	4
5	CB (CTS)	←	(DTR) CD	20
6	CC (DSR)	←	(CTS) CB	5
20	CD (DTR)	→	(DSR) CC	6
7	AB (GND)	—	(GND) AB	7

Figure 5.18-3 Cable Connection

Table 5.18-1 Serial Input/Output Interface Signal Names

Pin number	Signal name		Signal direction		Contents
			R3265A /3271A	External	
1	Ground	FG			Frame ground Used as protection
2	Transmit Data	TXD	→		Sending data
3	Receive Data	RXD	←		Receiving data
4	Request to Send	RTS	→		Sending request signal to external device. Permit to receive at "High" level, prohibition to receive at "Low" level.
5	Clear to Send	CTS	←		Sending clear signal from external device, Permit to send at "High" level, prohibition to send at "Low" level.
6	Data Set Ready	DSR			N.C.
7	Signal Ground	SG			Signal ground
8	Carrier Detector	DCD			N.C.
9~19					N.C.
20	Data Terminal Ready	DTR	→		Terminal ready
21~25					N.C.

5.18.3 Communication Port Setting

(1) Explanation on the Communication Port Setting Menu

Specify the RS-232C communication parameters through the window screen.

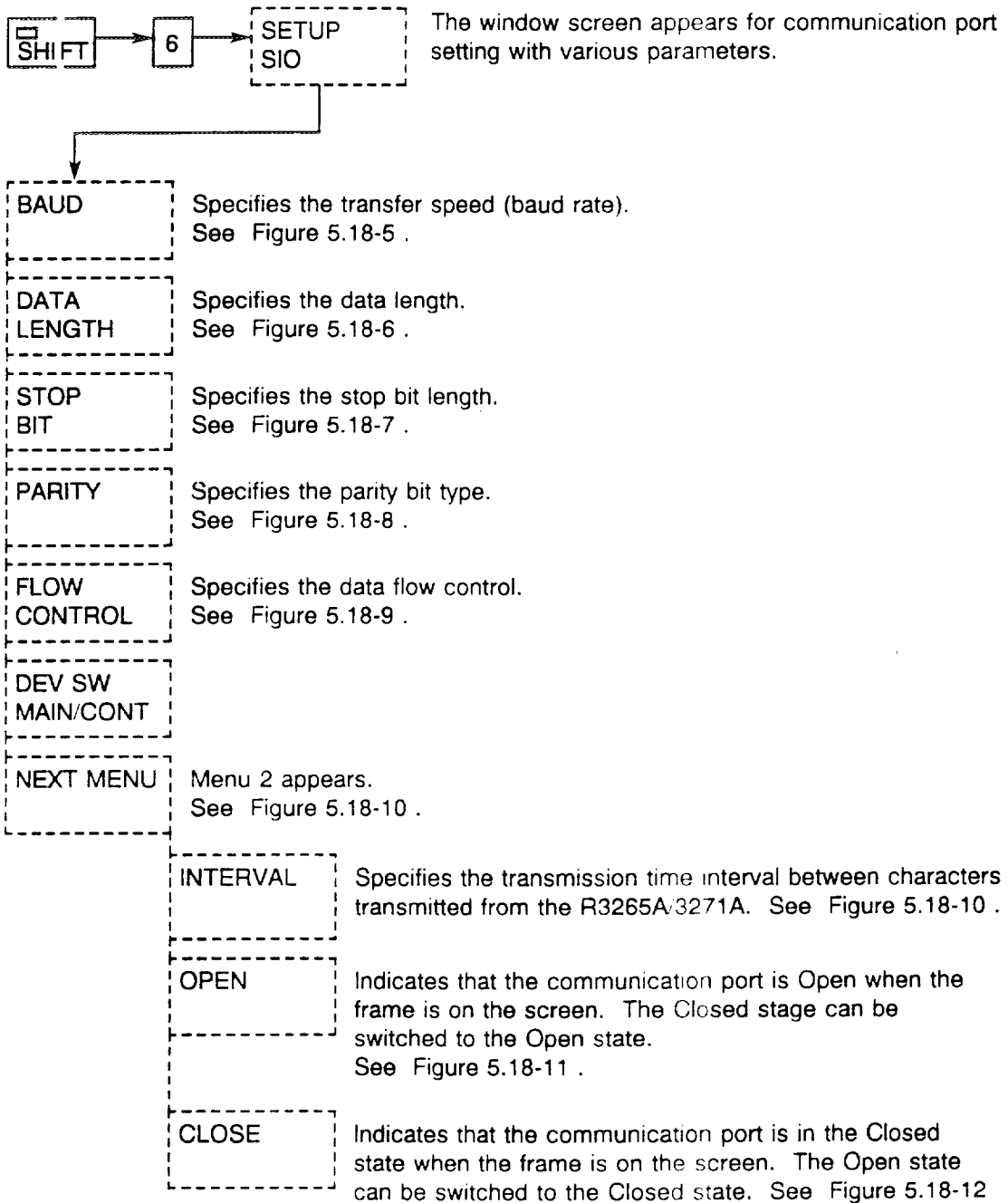

(2) Screen Display Examples

① Option select menu

Press the **SHIFT** **6** are pressed in this sequence.

Then the option select menu illustrated in Figure 5.18-4 will appear

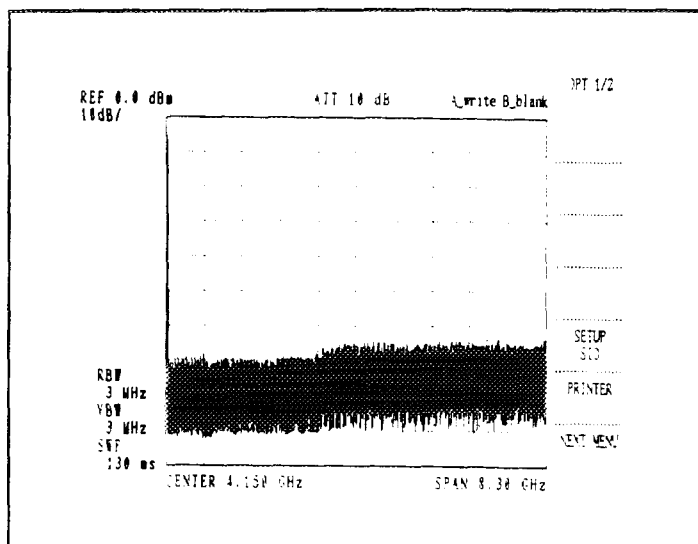
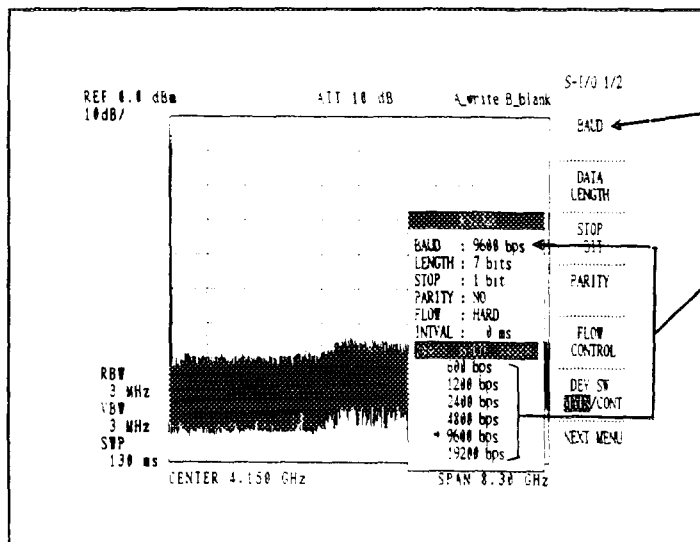

Figure 5.18-4 Option Select Menu

② Baud rate setting screen

Press the **SHIFT** **6** **SETUP SIO** **BAUD** in this sequence.

Then the menu illustrated in Figure 5.18-5 will appear.



Ⓐ

Pressing the soft key Ⓐ moves the arrow → to set a different value for the Baud rate.

Figure 5.18-5 Baud Rate Setting Menu

③ Data Length Setting Screen

Press the **SHIFT** **6** **SETUP SIO** **DATA LENGTH** in this sequence.

Then the menu illustrated in Figure 5.18-6 will appear.

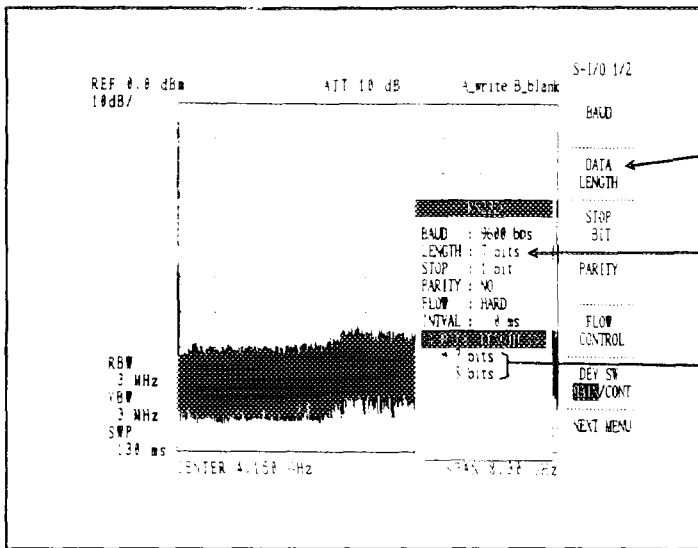

Pressing the soft key **B** moves the arrow \rightarrow to set a different value for the Data length.

Figure 5.18-6 Data Length Setting Menu

④ Stop Bit Setting Screen

Press the **SHIFT** **6** **SETUP SIO** **STOP BIT** in this sequence.

Then the menu illustrated in Figure 5.18-7 will appear.

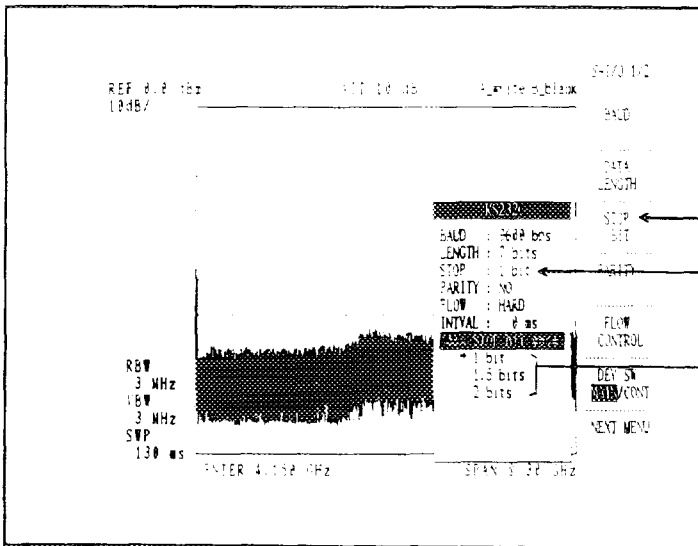

Pressing the soft key **C** moves the arrow \rightarrow to set a different value for the Stop bit.

Figure 5.18-7 Stop Bit Setting Screen

⑤ Parity Setting Screen

Press the **SHIFT** **6** **SETUP SIO** **PARITY** in this sequence.

Then the menu illustrated in Figure 5.18-8 will appear.

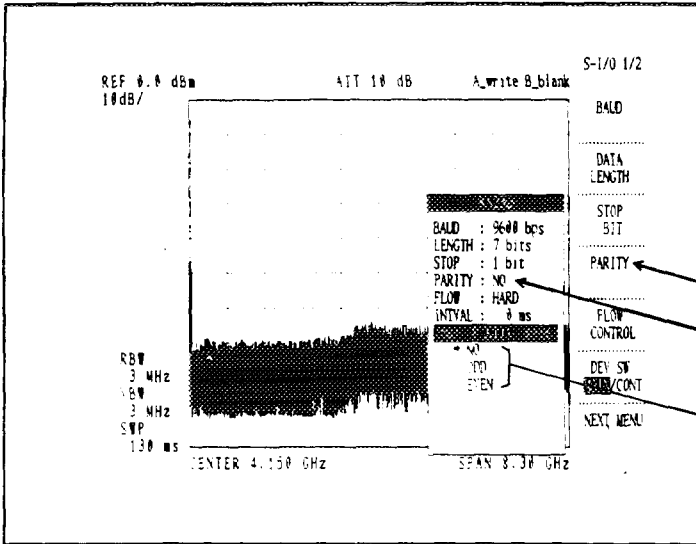

Figure 5.18-8 Parity Setting Menu

Pressing the soft key **D** moves the arrow → to set a different value for the Parity.

⑥ Flow Control Setting Screen

Press the **SHIFT** **6** **SETUP SIO** **FLOW CONTROL** in this sequence.

Then the menu illustrated in Figure 5.18-9 will appear.

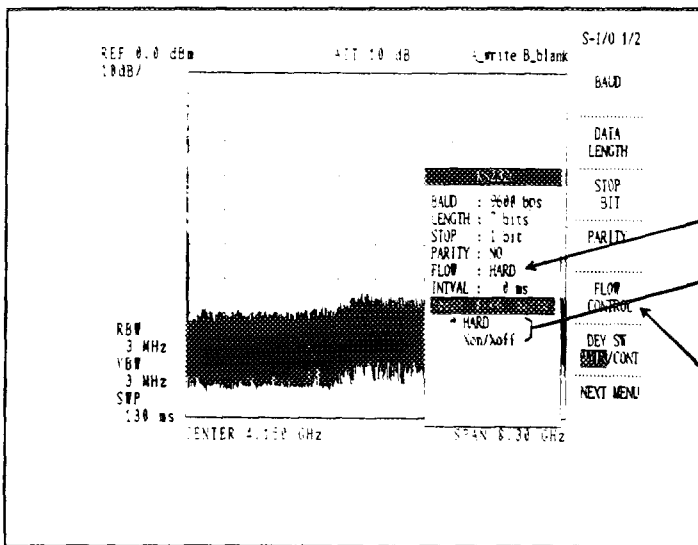

Figure 5.18-9 Flow Control Setting Menu

Pressing the soft key **E** moves the arrow → to set a different value for the Flow control.

⑦ Interval Setting Screen

Press the **SHIFT** **6** **SETUP SIO** **NEXT MENU** **INTERVAL** in this sequence.

Then the menu illustrated in Figure 5.18-10 will appear.

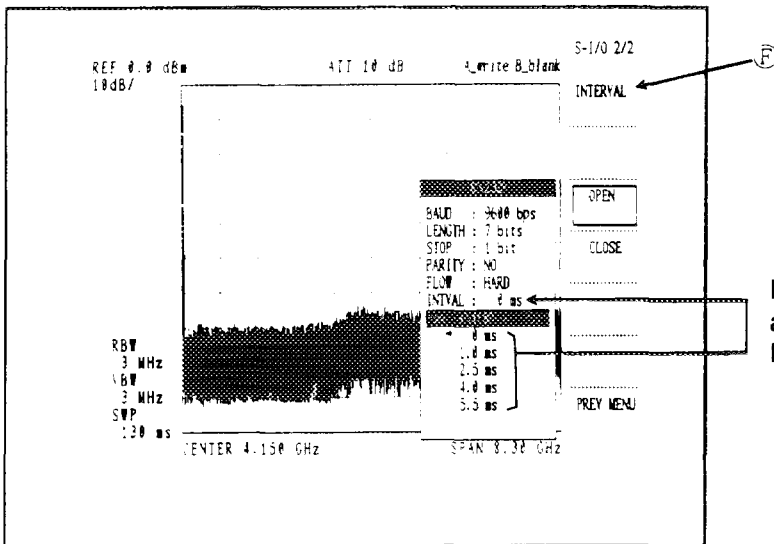

Pressing the soft key **F** moves the arrow \rightarrow to set a different value for the interval.

Figure 5.18-10 Interval Setting Menu

⑧ Communication Port Open/Close Setting Screen

Press the **SHIFT** **6** **SETUP SIO** **NEXT MENU** in this sequence.

Then press the **OPEN** to open or press the **CLOSE** to close the communication port. When the setting is ready, the frame will appear.

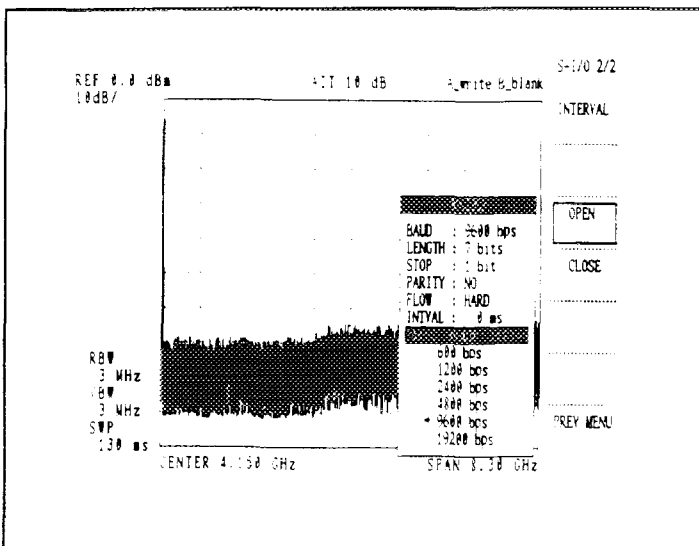

Figure 5.18-11 Screen of the Communication Port in Open state

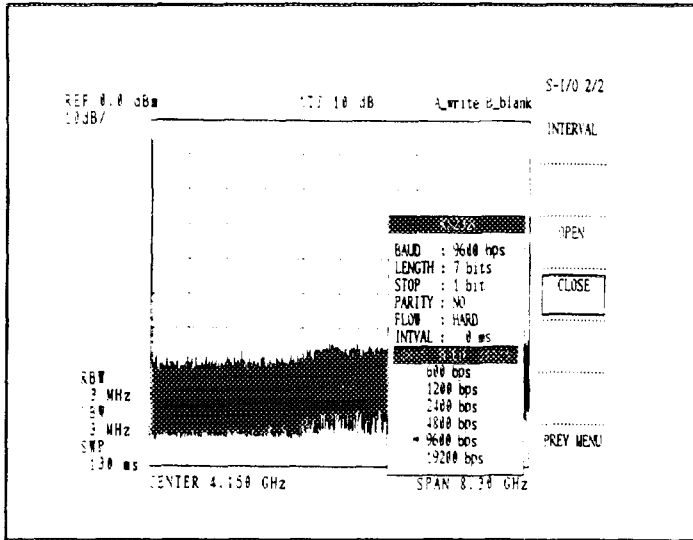
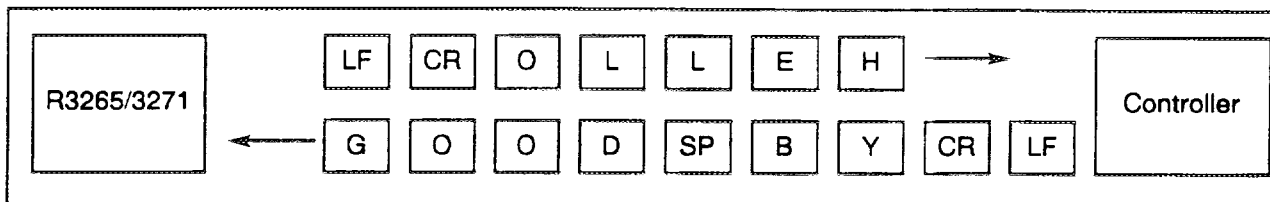

Figure 5.18-12 Screen of the Communication Port in Closed state

5.18.4 Message Format

A message transferred between the controller and the R3265A/3271A is basically an ASCII code characters string terminated by the carriage return (CR) and the line feed (LF) codes.

[Basic Format]



The waveform data binary format is transferred in the extended transfer format which can transparently transfer the 8-bit data.

[Extended Format]

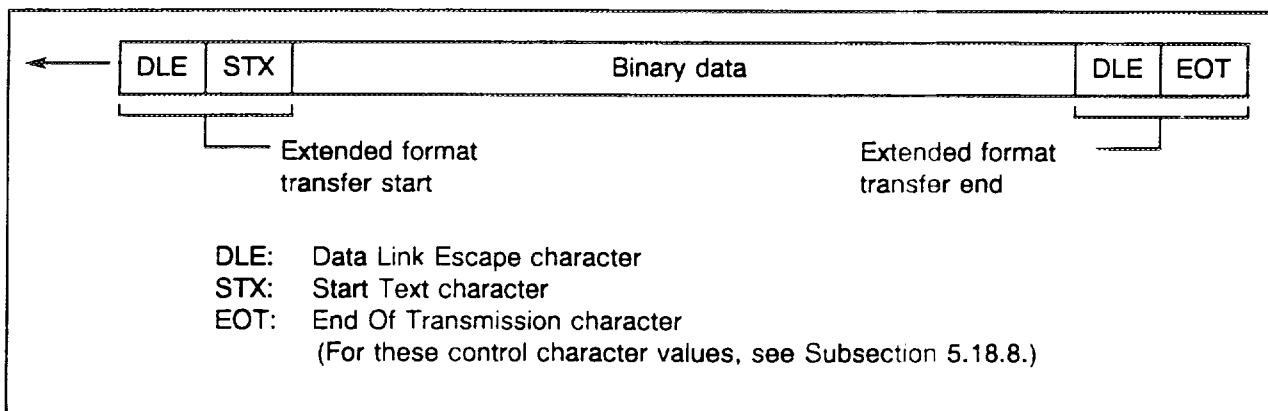

If the binary data exist a data with an identical code as the DLE character, a message end may be detected. To cope with this, an additional DLE character is inserted when transmitting the data and the additional DLE character is ignored when the data is received. With this operation, the data transparency is kept.

(Source data handling is explained in the examples 14 and 15 given in the Subsection 5.18.6.)

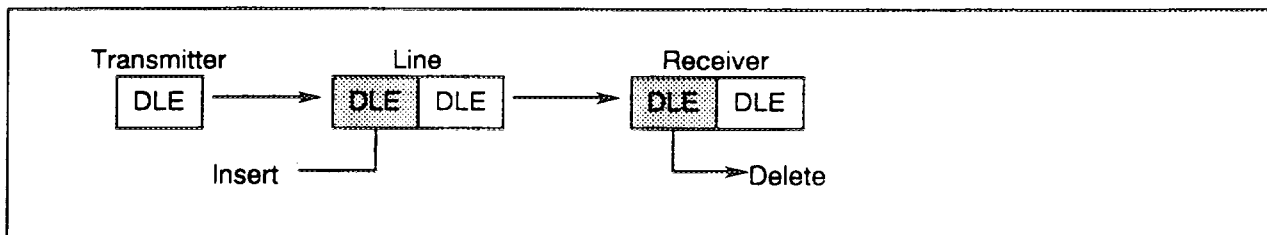

5.18.5 Difference from the GPIB Remote Programming

Note that the Serial I/O is in some points different from the GPIB remote programming.

(1) Command code

- ① GPIB commands which are not supported
 - ① Delimiter control: DL0, DL1, DL2, DL3, DL4
 - ② SRQ interrupt: S0, S1
- ② Additional commands for the RS-232C remote programming
 - ① Panel key lock control: KLK, KUK
 - ② Status byte read out: PLL?

(2) Panel control

When executing the RS-232C remote programming, the following specifications are set. (When executing the GPIB remote programming, the remote lamp on the panel is kept ON and the local operation is automatically inhibited.)

- ① The remote lamp will not light.
- ② The local operation will not be inhibited unless the KLK command is transmitted.
- ③ When the local operation is inhibited with the KLK command, it will not automatically released unless the KUK command is issued.
- ④ In case the KLK command has been issued to inhibit local operation and the processing is completed without releasing, the release can be executed with the LCL key or the IP key.

5.18.6 Sample Programs

This chapter explains how to use the Serial I/O through several examples. The programs shown below all use the "Microsoft Quick BASIC" produced by the Micro Soft Co., Ltd.

The sample program using the "HP-BASIC" of Heulette Packard are given in Subsection 5.18.9. The programs explained in the R3265A/3271A Instruction Manual Section 4.4 have been rewritten for this function in this chapter. For the program functions, see the R3265A/3271A Instruction Manual.

(1) Serial I/O Usage

- Sample Program 1

Example 1: Execute R3265A/3271A master reset and turn CAL signal (25MHz) ON.

The RS232C port is opened with specifications of 9600 baud; No parity; Data length 8-bit; Stop bit 1; Binary mode (Xon/Xoff control excluded); Line feed character insert mode; and DSR line monitor time out in 6 seconds.

```
OPEN "COM1:9600,N,8,1,DS6000,LF" FOR RANDOM AS #1
PRINT #1, "IP"
PRINT #1, "CLN"
END
```

Example 2: Set the start frequency to 300kHz and the stop frequency to 800kHz, and add 50kHz of the frequency offset.

```
OPEN "COM1:9600,N,8,1,DS6000,LF" FOR RANDOM AS #1
PRINT #1, "FA300KZ"
PRINT #1, "FB800KZ"
PRINT #1, "FON50KZ"
END
```

Example 3: Set the reference level to -20dBm (5dB/div), the resolution bandwidth to 100kHz, and the detector mode to posi.

```
OPEN "COM1:9600,N,8,1,DS6000,LF" FOR RANDOM AS #1
PRINT #1, "RE-20DB"           Reference level -20dBm
PRINT #1, "DD5DB"           5dB/div
PRINT #1, "RR100KZ"         Resolution bandwidth 100kHz
PRINT #1, "DTP"             Detector mode is set to posi.
END
```

Example 4: Set the trigger mode to Single and the sweep time to 2 seconds; and set the marker at the maximum level at each sweep.

```

OPEN "COM1:9600,N,8,1,DS6000,LF" FOR RANDOM AS #1

PRINT #1, "SI"
PRINT #1, "SW2SC"

SWLOOP:
  PRINT #1, "S2"           Status byte clear
  PRINT #1, "SR"           Sweep start
  DO                        Waiting for the Sweep end
    PRINT #1, "PLL?"
    INPUT #1, A$
    SB = VAL(A$)
  LOOP UNTIL SB AND &H4
  PRINT #1, "PS"           The marker peak search
GOTO SWLOOP
END

```

Example 5: Set MAX HOLD (A).

```

OPEN "COM1:9600,N,8,1,DS6000,LF" FOR RANDOM AS #1

PRINT #1, "AM"           Direct setting
' Or
'PRINT #1, "TA SF4"       Set through soft key operation
END

```

Example 6: Recall. (for channel 5)

```

OPEN "COM1:9600,N,8,1,DS6000,LF" FOR RANDOM AS #1

PRINT #1, "RN"           Switch to the Normal mode.
PRINT #1, "RC 5 SF1"     Recall channel 5.
' Or
'PRINT #1, "RF"           Switch to Fast mode
'PRINT #1, "RC 5"        Recall channel 5.
END

```

Example 7: Output the marker frequency (Integer).

```

OPEN "COM1:9600,N,8,1,DS6000,LF" FOR RANDOM AS #1

PRINT #1, "H00"           Header output suppress
PRINT #1, "MF?"
INPUT #1, A$
B = VAL(A$)               Result example B = 1700000
END

```

Example 8: Output the center frequency (character string).

```

OPEN "COM1:9600,N,8,1,DS6000,LF" FOR RANDOM AS #1

PRINT #1, "HD1"           Header output start
PRINT #1, "CF?"
INPUT #1, AS              Result example AS = CF 0000001.8000E + 9

END

```

Example 9: Output the unit status.

```

OPEN "COM1:9600,N,8,1,DS6000,LF" FOR RANDOM AS #1

PRINT #1, "UN?"
INPUT #1, A               Result example A = 2 (dBuv)

END

```

Example 10: Output the marker frequency and the level at once.

```

OPEN "COM1:9600,N,8,1,DS6000,LF" FOR RANDOM AS #1

PRINT #1, "HD0"           Header output suppress
PRINT #1, "MFL?"
INPUT #1, Mf$, M1$
Mff = VAL(Mf$)            Result example Mff = 1.8E + 0.9 M11 = -73.02
M11 = VAL(M1$)
END

```

Example 11: Output the frequency offset.

```

OPEN "COM1:9600,N,8,1,DS6000,LF" FOR RANDOM AS #1

PRINT #1, "HD0"           Header output suppress
PRINT #1, "FO?"
INPUT #1, On$, Frq$
Frqq = VAL(frqq$)        Result example On$ = 1 Frqq = 1200000
END

```

Example 12: Using the NEXT PEAK, read 10 peak levels from the signal second peak level.

```
DIM M1$(9), M11(9)
PEN "COM1:960G,N,8,1,DS6000,LF" FOR RANDOM AS #1

PRINT #1, "PS"
FOR I = 0 TO 9
  PRINT #1, "NXP"
  PRINT #1, "ML?"
  INPUT #1, M1$(I)
  M11(I) = VAL(M1$(I))
NEXT I
  Result example M11(1) = -55.01 M11(2) = -58.22...M11(9) = -70.26
END
```

(2) Trace Data I/O

The trace data I/O is basically identical in the GPIB. The ASCII formats including the data value contents, message format, delimiter (fixed), and transfer count are all of equivalent specifications.

The binary formats for the data value, data transfer priority, and the data byte count are all the same, excluding that a control character is inserted at the beginning and the end of each data. (See Subsection 5.18.4 [Extended Format].) If a data item identical to the DLE character is found among the data items, it should be noted that an additional DLE character has been inserted. (Note: The data length should be set to 8 bits. If a 7-bit data is transferred, the uppermost bit of the waveform data will be missing and a correct waveform may not be created.)

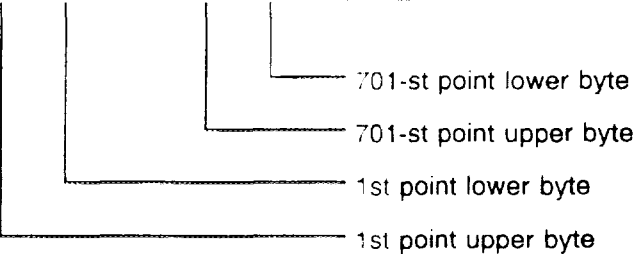
I/O	Description									
ASCII format	<p><u>DDDD</u> CR LF</p> <p>1-point data</p> <p>4-byte data without a header</p> <table border="1" data-bbox="571 827 1263 982"> <thead> <tr> <th data-bbox="571 827 802 877"></th> <th data-bbox="802 827 1032 877">Input code</th> <th data-bbox="1032 827 1263 877">Output code</th> </tr> </thead> <tbody> <tr> <td data-bbox="571 877 802 928">Memory A</td> <td data-bbox="802 877 1032 928">TAA</td> <td data-bbox="1032 877 1263 928">TAA?</td> </tr> <tr> <td data-bbox="571 928 802 982">Memory B</td> <td data-bbox="802 928 1032 982">TAB</td> <td data-bbox="1032 928 1263 982">TAB?</td> </tr> </tbody> </table>		Input code	Output code	Memory A	TAA	TAA?	Memory B	TAB	TAB?
	Input code	Output code								
Memory A	TAA	TAA?								
Memory B	TAB	TAB?								
Binary format	<p><u>DLE STX</u> DD DD DD DD <u>DLE EOT</u></p>  <p>A 1-point data is divided into two bytes: the upper and lower of a binary value when transferred.</p> <table border="1" data-bbox="571 1478 1263 1633"> <thead> <tr> <th data-bbox="571 1478 802 1528"></th> <th data-bbox="802 1478 1032 1528">Input code</th> <th data-bbox="1032 1478 1263 1528">Output code</th> </tr> </thead> <tbody> <tr> <td data-bbox="571 1528 802 1579">Memory A</td> <td data-bbox="802 1528 1032 1579">TBA</td> <td data-bbox="1032 1528 1263 1579">TBA?</td> </tr> <tr> <td data-bbox="571 1579 802 1633">Memory B</td> <td data-bbox="802 1579 1032 1633">TBB</td> <td data-bbox="1032 1579 1263 1633">TBB?</td> </tr> </tbody> </table>		Input code	Output code	Memory A	TBA	TBA?	Memory B	TBB	TBB?
	Input code	Output code								
Memory A	TBA	TBA?								
Memory B	TBB	TBB?								

- Sample Program 2

Example 13: Output data from Memory A in ASCII.

OPEN "COM1:9600,n,8,1,DS2000,LF" FOR RANDOM AS #1	
DIM TR\$(700)	701 variables are fetched.
PRINT #1, "TAA?"	Memory A is set to ASCII.
FOR I = 0 TO 700	Data fetch is repeated 701 times.
INPUT #1, TR\$(I)	
NEXT I	
END	

Result example: TR\$(0)=0208 TR\$(1)=0210 TR\$(699)=0311 TR\$(700)=0298

Example 14: Output data from Memory B in Binary.

The RS-232C port is opened in Binary mode; and in mode without Line feed character insert.

OPEN "COM1:9600,n,8,1,DS6000" FOR RANDOM AS #1	
DIM TR\$(1500)	
CONST DLE = 16, STX = 2, EOT = 4	
CONST CR = 13, LF = 10	Control character definition
DLEflag = 0	Flag for DLE character delete control
i = 3	
PRINT #1, "TBB?; CHR\$(CR); CHR\$(LF);	
TR\$(1) = INPUT\$(1, #1)	DLE character received
TR\$(2) = INPUT\$(1, #1)	STX character received
TR\$(3) = INPUT\$(1, #1)	1st byte of Waveform data received
DO	
IF (DLEflag = 0) THEN	DLE character inserted in the
IF (TR\$(i) = CHR\$(DLE)) THEN DLEflag = 1	waveform data is detected.
ELSE	
IF (TR\$(i) = CHR\$(DLE)) THEN	The additional DLE character is deleted.
DLEflag = 0	
i = i - 1	
ELSE	
IF (TR\$(i) <> CHR\$(EOT)) THEN DLEflag = 0	
END IF	
END IF	
i = i + 1	
TR\$(i) = INPUT\$(1, #1)	Waveform data fetch
LOOP WHILE (NOT ((DLEflag = 1) AND (TR\$(i) = CHR\$(EOT))))	Data end detected
	DLE character + EOT
	character
STOP	
END	

Example 15: Input data from Memory A in ASCII.

```

DIM TR$(700)
OPEN "COM1:9600,n,8,1,DS6000,LF" FOR RANDOM AS #1

PRINT #1, "TAB"
FOR I = 0 TO 700
  PRINT #1, TR$(I)
  FOR J = 0 TO 10
    NEXT J
  NEXT I

STOP
END

```

It is assumed that a waveform data is set in TR\$().

Processing time is required in SPA.

Note: Set the VIEW mode before executing the program. After execution press the VIEW key again to check the results of entry

Example 16: Input data from memory B in Binary.

The RS-232C port is opened in Binary mode and in mode without Line feed character insert.

```

OPEN "COM1:9600,n,8,1,DS6000,LF" FOR RANDGM AS #1

DIM TR$(1500)
CONST DLE = 16, STX = 2, EOT = 4
CONST CR = 13, LF = 10

PRINT #1, "TBB; CHR$(CR); CHR$(LF);
PRINT #1, CHR$(DLE); CHR$(STX);
FOR J = 0 TO 1401
  IF (TR$(J) = CHR$(DLE)) THEN
    PRINT #1, CHR$(DLE);
    FOR K = 0 TO 1
      NEXT K
    END IF
  PRINT #1, TR$(J);
  FOR K = 0 TO 1
    NEXT K
  NEXT J
PRINT #1, CHR$(DLE); CHR$(EOT);

STOP
END

```

Control character definition

It is assumed that a data has been set in the TR\$() by "TBA?" or "TBB?".

Wait time is required to assure the processing time in SPA.

Wait time is required to assure the processing time in SPA.

Note: Set the VIEW mode before executing the program. After execution, press the VIEW key again to check the results of entry.

(3) Status Byte Read-out Function

The remote programming functions "Service Request (SRQ)" and "Status Byte" are inherent to the GPIB and not supported by any options. However, for normal message exchange, the status byte data read-out function has been added.

The status byte data is transmitted from the R3265A/3271A as a 2-byte ASCII data with the Status byte read-out code (PLL?).

Table 5.18-2 Status Byte Control Codes

Message code	Description
PLL?	Request for read the status byte information from the R3265/3271.
S2	The R3265A/3271A status byte is cleared. (Same as the GPIB code)

Table 5.18-3 Status Byte Information

Bit	Decimal	Description
0	1	Turns ON when UNCAL has occurred.
1	2	Turns ON when a calibration is complete.
2	4	Turns ON when a sweep is complete.
3	8	Turns ON when the average count is reached.
4	16	Turns ON when the plot output is completed.
5	32	Turns ON when an error is detected in the message code of this function.
6	64	Undefined
7	128	Undefined

An example of Status byte

Sweep complete and the Average count reached. (4 + 8 = 12)

31	32	CR	LF
----	----	----	----

- Sample Program - 3

Example 17: Read-out the average count end.

```

OPEN "COM1:9600,N,8,1,DS6000,LF" FOR RANDOM AS #1

PRINT #1, "S2"
PRINT #1, "AG 30GZ"
SW:
  PRINT #1, "PLL?"
  INPUT #1, StatusByte$
  SB = VAL(StatusByte$)
  IF (SB AND &H8) = 0 THEN GOTO SW
PRINT "AVG. END"
END

```

The status byte is cleared.
Average A start (30 times)

The Status byte is read out.

The loop completion is indicated until bit 3 turns ON.

Example 18: Read out the single sweep end with an interval.

```

OPEN "COM1:9600,N,8,1,DS6000,LF" FOR RANDOM AS #1

PRINT #1, "SI"
PRINT #1, "S2"
PRINT #1, "SR"
SW:
  PRINT #1, "PLL?"
  INPUT #1, StatusByte$
  SB = VAL(StatusByte$)
  IF (SB AND &H4) = 0 THEN GOTO SW
PRINT "SWEEP END"
END

```

Set to Single
The status byte is cleared.
Sweep start

The status byte is read out.

The loop completion is indicated until bit 2 turns ON.

Example 19 shows data flow control set to "Xon/Xoff" control.
This is a modification of Example 10.

**Example 19: Output the marker frequency and the level at once.
(Xon/Xoff CONTROL)**

The RS-232C port is opened with specifications of 9600 baud; No parity; Data length 8-bit; Stop bit 1; ASCII mode (Xon/Xoff control); Line feed character insert mode; and DSR line monitor time out in 6 seconds.

```

OPEN "COM1:9600,N,8,1,ASC,DS6000,LF" FOR RANDOM AS #1

PRINT #1, "HD0"
PRINT #1, "MFL?"
INPUT #1, Mf$, MI$
Mff = VAL(Mf$)
M11 = VAL(MI$)
END

```

Header output suppress

Result example Mff = 1.8E+09 M11 = -73.02

(4) Panel Key Lock Function

The GPIB remote control is equipped with the Remote/Local Enable as a function to inhibit local operation. The Serial I/O can also execute the equivalent function through message transmission.

This function is called Panel Lock. Once Panel Lock of the R3265A/3271A is requested from the controller, the panel key operation or knob operation are ignored until a Panel Unlock message or a Local message (LC) is transmitted. Note that the panel lock state can also be released by one of the following operations:

- Press the LCL key.
- Press the IP key.
- Turn OFF the R3265A/3271A power.

In the Panel Lock state, soft menu on the screen cannot be modified with commands from the controller.

Table 5.18-4 Panel Lock Code

Message code	Description
KLK	The R3265A/3271A panel key operation is inhibited. (Panel Lock)
KUK	The R3265A/3271A panel key operation is enabled. (Panel Unlock)

5.18.7 Data Communication Error

While executing the RS-232C remote programming, a communication error such as Time Out may be caused in the controller due to some reason. In such a case, the remote operation can be issued by re-transmitting the last message (command) which has been transmitted from the controller.

This section describes a simple recovery program using the "Quick BASIC" of Micro Soft Co., Ltd.

- Sample program - 4

Example 20: Using the NEXT PEAK, read 10 peak levels from the signal second peak level. (This is a combination of Example 12 and a communication error processing.)

```

CONST CommTimeOut = 24           Time Out error No.
CONST CommBuffOver = 69         Buffer over flow error No.

DIM M1$(9), M11(9)
OPEN "COM1:9600,N,8,1,DS6000,LF" FOR RANDOM AS #1
ON ERROR GOTO Commerror

PRINT #1, "PS"
FOR I = 0 TO 9
  PRINT #1, "NXP"
  PRINT #1, "ML?"
  INPUT #1, M1$(I))
NEXT I
STOP

Result example: M11 (1) = -55.01 M11(2) = -58.22...
Communication error processing routine

Commerror:
  IF ERR = CommTimeOut THEN
    IF RetryCount = 5 THEN
      ON ERROR GOTO 0
    END IF
    RetryCount = RetryCount + 1
    PRINT "Communication TIME OUT !!!"
    FOR J = 0 TO 5000
    NEXT J
    PRINT "Retry communication !?"
    RESUME
  ELSE
    IF ERR = CommBuffOver THEN
      PRINT "Communication buff. overflow !!!"
      RESUME
    END IF
    PRINT "Something Error has been occurred."
    PRINT "Error no. :"; ERR
    ON ERROR GOTO 0
  END IF
END

```

5.18.8 Control Character Code List

Symbol	Hex. code	Description
STX	02h	Used as a header in Binary data transfer.
EOT	04h	Used as a delimiter in Binary data transfer.
LF	0Ah	Used as a delimiter in ASCII data transfer.
CR	0Dh	Used as a delimiter in ASCII data transfer.
DLE	10h	Used as a control character in Binary data transfer.
Xon	11h	X parameter transfer start character
Xoff	13h	X parameter transfer suppress character

5.18.9 HP-BASIC Sample Programs

Some of the sample programs given in Subsection 5.18.6 are described in HP-BASIC (Example 17).

HP-BASIC

```

20      !
30      !*****
40      !      DO AVERAGING OPERATION THRU. SIO
50      !*****
60      !
70      DIM Message(1) [130]
80      Sc=20
90      ON ERROR GOTO Error      ! Set up error trap routine
100     GOSUB Sio_init
110     OUTPUT Sc:"S2"
120     OUTPUT Sc:"AG 30GZ"
130 LI: !
140     OUTPUT Sc:"PLM"
150     ENTER Sc:1
160     IF BIT (S.B. 1) THEN LI
170     PRINT "AVG. END"
180     STOP
190 !*****
200 !      ERROR HANDLING ROUTINE
210 !*****
220 Error:      ! Error trap
230     IF ERRN>127 THEN Other_error
240     STATUS Sc:10:Cart_error      ! Get UART error information
250     IF BIT (Cart_error.0) THEN Overrun      ! Overrun error
260     IF BIT (Cart_error.1) THEN Parity      ! Parity error
270     IF BIT (Cart_error.2) THEN Framing      ! Framing error
280     IF BIT (Cart_error.7) THEN Break      ! Break detected
290 Other:      ! Other error
300     PRINT "Other error !"
310     STOP
320 Overrun:      ! Overrun error
330     PRINT "Overrun error !"
340     STOP
350 Framing:      ! Framing error
360     PRINT "Framing error !"
370     STOP
380 Break:      ! Break
390     PRINT "Break detected !"
400     STOP
410 Other_error:      ! NO ERROR
420     PRINT "Error trapped ?"
430     STOP
440 !*****
450 !      SERIAL COMMUNICATION I/F INITIALIZE
460 !*****
470 Sio_init:      ! Initialize SIO Control reg.
480     CONTROL Sc,0:1      ! Reset I/F board
490     CONTROL Sc,3:1      ! Set PROTOCOL TO Async.

```

(cont'd)

```
500 Wait:      STATUS Sc.38:All_sent
510           IF NOT All_sent THEN Wait
520           CONTROL Sc.0:1          ! Reset I.F Card
530           CONTROL Sc.14:1-2-4     ! Set Control Block Mask
540           ! CONTROL Sc.39:4        ! Set Break signal time
550           ! CONTROL Sc.6:1         ! Break signal send
560           CONTROL Sc.8:3           ! Set DTR RTS line
570           CONTROL Sc.13:128-1     ! Set INT mask
580           CONTROL Sc.15:0         ! No modem time-change notifi-
                                           cation
590           CONTROL Sc.16:0         ! Disable connection time out
600           CONTROL Sc.17:0         ! Disable nonactivity time out
610           CONTROL Sc.18:40        ! Lost Carrier 400 ms
620           CONTROL Sc.19:10        ! Transmit time out 10S
630           CONTROL Sc.20:15        ! Set Transmit speed : 19200
640           CONTROL Sc.21:15        ! Set Receive Speed : 19200
650           CONTROL Sc.22:0         ! Set protocol handshake to non
660           CONTROL Sc.23:3         ! Set H.W handshake type
670           CONTROL Sc.24:2
680           CONTROL Sc.28:2         ! Set EOL chra. NO.
690           CONTROL Sc.29:13        ! Set CR code
700           CONTROL Sc.30:10        ! Set LF code
710           CONTROL Sc.34:3         ! Set DATA LENGTH 8 BIT
720           CONTROL Sc.35:0         ! Set STOP BIT TO 1 BIT
730           CONTROL Sc.36:0         ! Set PARITY TO NON
740           CONTROL Sc.37:0         ! Set CHAR. INTERVAL
750           RETURN
760           !!!!!
770           END
```

5.18.10 Exception Processing

The R3265A/3271A interrupts the current communication processing and executes the corresponding exception processing when the following states are caused.

- ① **State:** In receiving a message from the controller (before the delimiter character string is received), more than 5 seconds have passed without receiving the next character.

Processing: The message is canceled and the break signal is generated. The next character received is handled as a start of another message.

- ② **State:** In transmitting a message to the controller, the transmit suppress from the controller has not been released in 5 seconds after the last character was transmitted.

Processing: The message transmission is interrupted and preparation is made for the next transmission/reception.

- ③ **State:** During a trace data input, no transmission can be detected from the controller for more than 25 seconds under the condition that the specified number of times (ASCII format) or the specified number of bytes (Binary format) has not been reached.

Processing: The trace data input mode is released and preparation is made for the next transmission/reception.

- ④ **State:** In receiving a message, a framing error, parity error or overrun error occurs.

Processing: The message is canceled and the break signal is generated. The next character received is handled as a start of another message.

5.19 Simulated Analog Display Function

New data accumulation and display technology enables an analog display of the digital display in the simulated analog display of the R3265A/3271A series.

Since all displayed data are stored in the memory, the frequency and level can be read out by using the marker.

Complex modulation signals such as image signals which could be displayed only on an analog display were easily observable using this function.

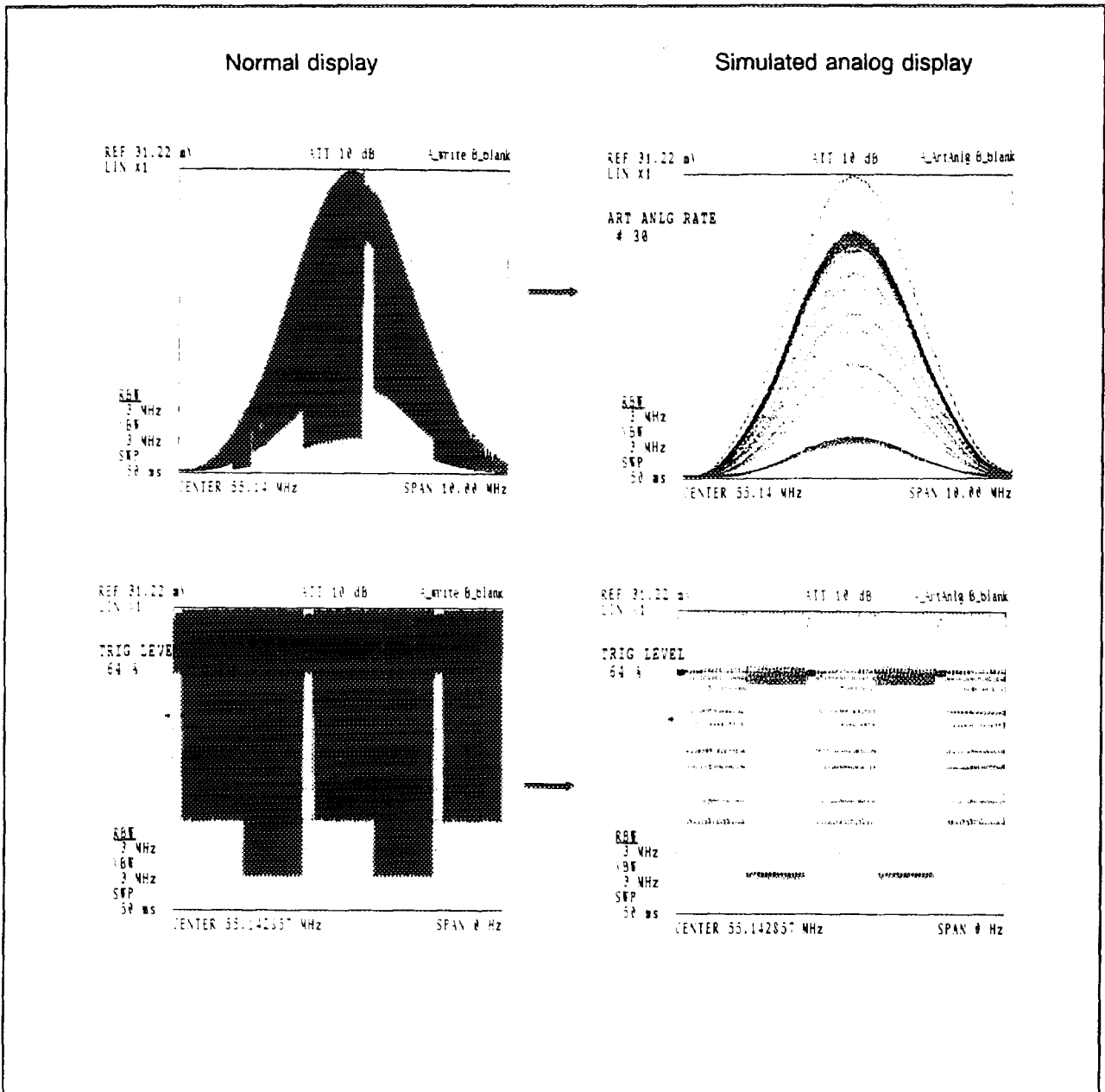

5.19.1 Functional Explanation

(1) Menu for simulated analog display function

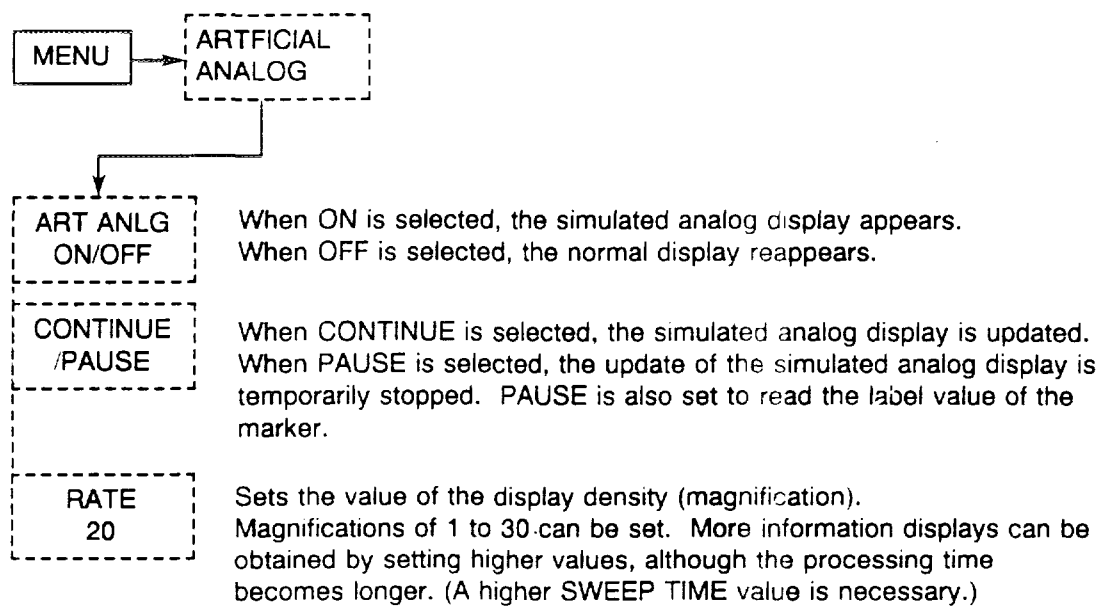

(2) Menu for marker function

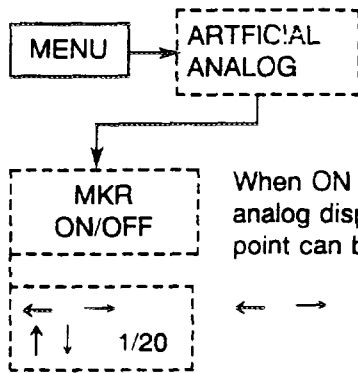

When ON is selected, the specified marker (▼) for the simulated analog display is displayed and the frequency and level of the marker point can be read. When OFF is selected, the marker disappears.

← → : The marker can be moved in the frequency axis direction.
Enter the frequency data to move the marker.

↑ ↓ 1/20 : Moves the marker in the upper or lower direction of the level on the same frequency. When RATE = 20 (twentyfold display density) is set, the levels are entered in the order 1/20 to 20/20. At 20/20, the marker indicates the highest level data on the same frequency. Conversely, at 1/20, the marker indicates the lowest level data on the same frequency.

If the level value is read while the marker is moving, the waveform display should be stopped as follows:

- Change CONTINUE to PAUSE.
- Turn the SWEEP mode to single, then stop after a single sweep.

The level difference (relative value) between the marker and the display line can be displayed by turning on the display line. However, the REL/ABS should be set to REL (NEXT menu for marker on).

Exclusive-use Marker Function

- Frequency of false analog waveform data and read out of level
- Peak search operation (Press the PEAK key.)
- Marker→CF operation (Press the keys in order MKR→, MKR→CF.)
- Marker→REF operation (Press the keys in order MKR→, MKR→REF.)
- The level when the vertical axis scale represents the linear X1 is a unit of %.

(3) Menu for cursor function

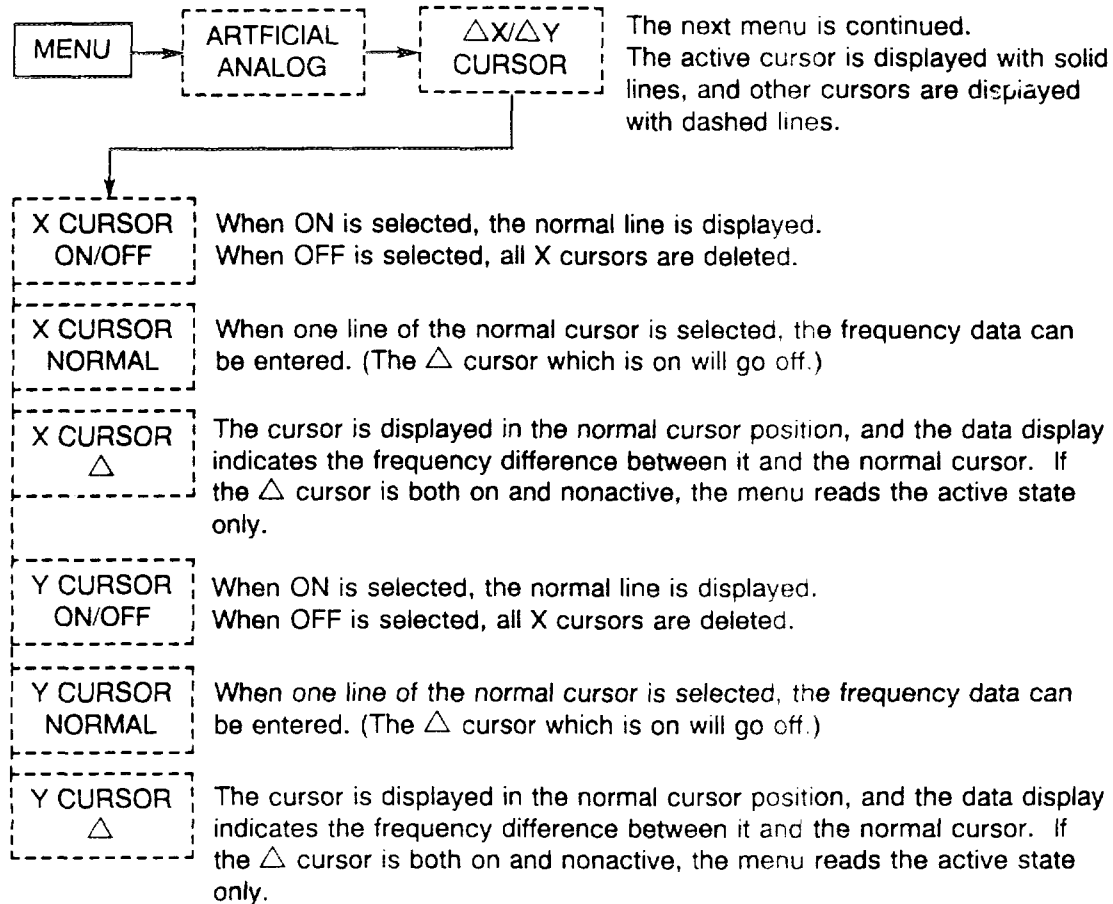

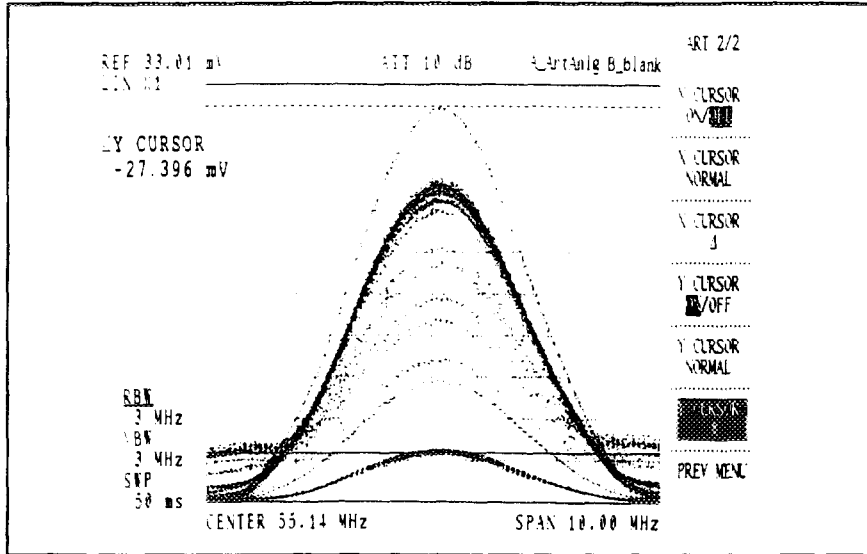

CAUTION

1. The trace mode for the trace A memory cannot be changed while the simulated analog display is being displayed.
2. The normal marker cannot be displayed on the false analog waveform.
3. The save/recall (setting condition and waveform data) for the simulated analog display cannot be executed.
4. The plotter for the simulated analog display cannot be output.

5.19.2 GPIB remote programming

(1) List of GPIB commands

GPIB command	Contents
ANLG 1 to 30 ANLG ON ANLG OFF ANLG?	Sets the value of the display density (magnification). Turns the simulated analog display on. Turns the simulated analog display off. Outputs the simulated analog display ON/OFF (1/0) and the display density (1 to 30).
ANLG CONT ANLG PAUSE	Sets the consecutive mode. Sets the temporary stop.
MKX Frequency MKX? MKY 1 to 30 MKY? MKX ON MKX OFF	Sets the marker by frequency. Reads out the marker frequency. Sets the vertical marker position at a value between 1 and 30. Reads out the marker level. Turns the marker on. Turns the marker off.
CSRX Frequency CSRX? CSRDX Δ Frequency CSRDX? CSRX ON CSRDX ON CSRX OFF	Sets the X cursor by frequency. Reads out the frequency of the X cursor. Turns the Δ X cursor on and sets Δ X by frequency. Reads out the frequency width of Δ X. Turns the X cursor on. Turns the Δ X cursor on. Turns all of the Δ cursors off.
CSRY Level CSRY? CSRDY Δ Level CSRDY? CSRY ON CSRDY ON CSRY OFF	Sets the Y cursor in level. Reads out the level of the Y cursor. Turns the Δ Y cursor ON and sets the Δ Y by level. Reads out the frequency width of Δ Y. Turns the Y cursor on. Turns the Δ Y cursor on. Turns all of the Y cursors off.
OPANLG?	Reads out all of the waveform data.

(2) Wave data output format for OPANLG? command

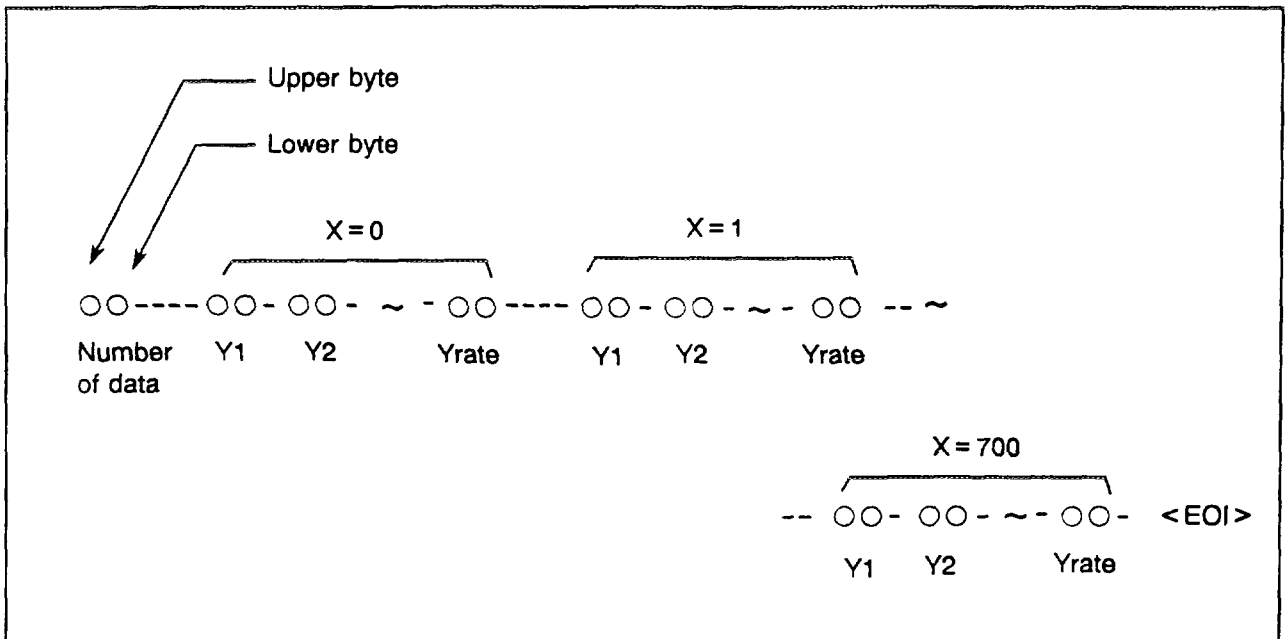

- To output binary data consecutively in the order of upper byte then lower byte, read out as one-word data (upper + lower).
- The head of the data represents the total number of words in the waveform data. Subsequently, the waveform data continue, and the data are read out until the EOI signal is generated.
- For example, at rate = 10 the number of the waveform data shows $10 \times 701 = 7010$ words.

(3) Sample program

For example, indicate the program which reads out all of the waveform data.

Note : Turn the simulated analog display on to execute the following program in the PAUSE state.

Example of HP200/HP300 series program (GPIB address = 8)

```
10     INTEGER Tr(21031)
20     OUTPUT 708;"TPC; DL2; HD0; ANLG?"
30     ENTER 708;"Onoff,Rate
40     OUTPUT 708;"OPANLG?"
50     ENTER 708 USING "%,W";Tr(*)
60     OUTPUT KBD;" K";
70     GINIT
80     GRAPHICS ON
90     CONTROL 1,12;1
100    VIEWPORT 10,120,15,90
110    WINDOW 0,700,0,400
120    GRID 70,40,0,0,10,10,100
130    N=1
140    FOR I=0 TO 700
150        FOR J=1 TO Rate
160            MOVE I,Tr(N)
170            DRAW I,Tr(N)
180            N=N+1
190        NEXT J
200    NEXT I
210    END
```

5.20 Limit Line PASS/FAIL Function

The upper and lower limits of the waveform on the screen are automatically judged (determined) by limit line 1 and limit line 2. Set limit line 1 and limit line 2 as follows:

Limit line 1: Upper (Always set at the upper side of the target waveform.)

Limit line 2: Lower (Always set at the lower side of the target waveform.)

(1) Menu for limit line PASS/FAIL function

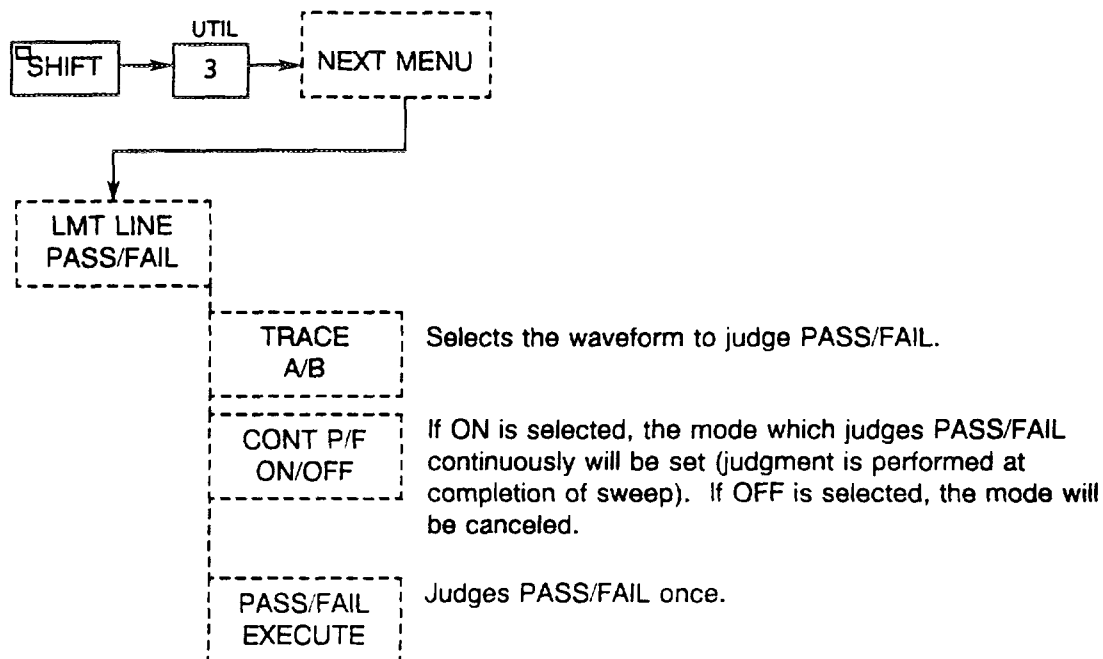

(2) PASS/FAIL display screen

During key operation or when the continuous mode is on, the judgment result is shown on the following screens:

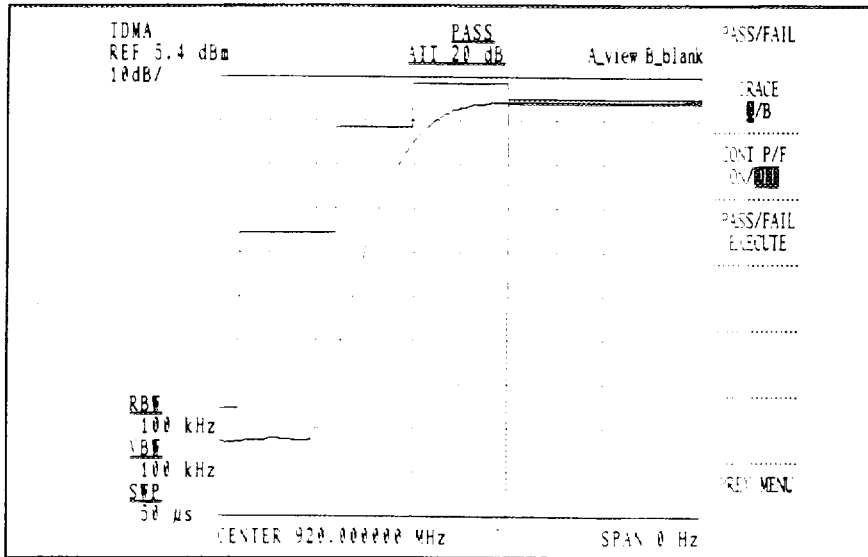

Figure 5.20-1 Display when PASS

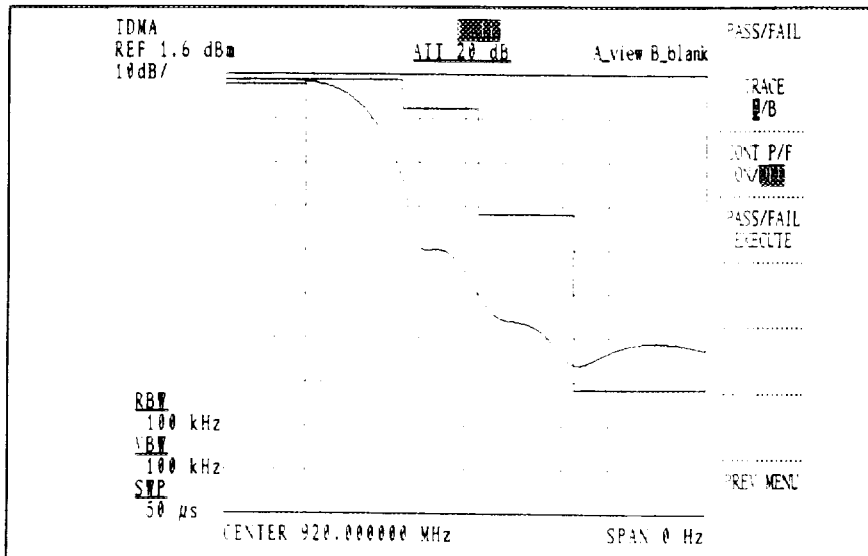

Figure 5.20-2 Display when FAIL

CAUTION

The result is not displayed when executing from the GPIB.

(3) PASS/FAIL judgment

① For PASS

- When limit line 1 and 2 are displayed, all the measurement waveform points are within the range lower to upper.
- When limit line 1 only is displayed, all the measurement waveform points are within the range upper or below.
- When limit line 2 only is displayed, all the measurement waveform points are within the range lower or above.
- When there is no limit line, judge as PASS.
- When the limit line is on the line, judge as PASS.

② For FAIL

- Both limit line 1 and limit line 2 are OFF.
- The target waveform to be judged is blank.
- The measured waveform point is beyond the limit line. (The PASS condition is not satisfied.)

③ When using measuring window

- When the measuring window is on, judge the PASS/FAIL in the window. However, judgment is not performed in the Y axis direction.

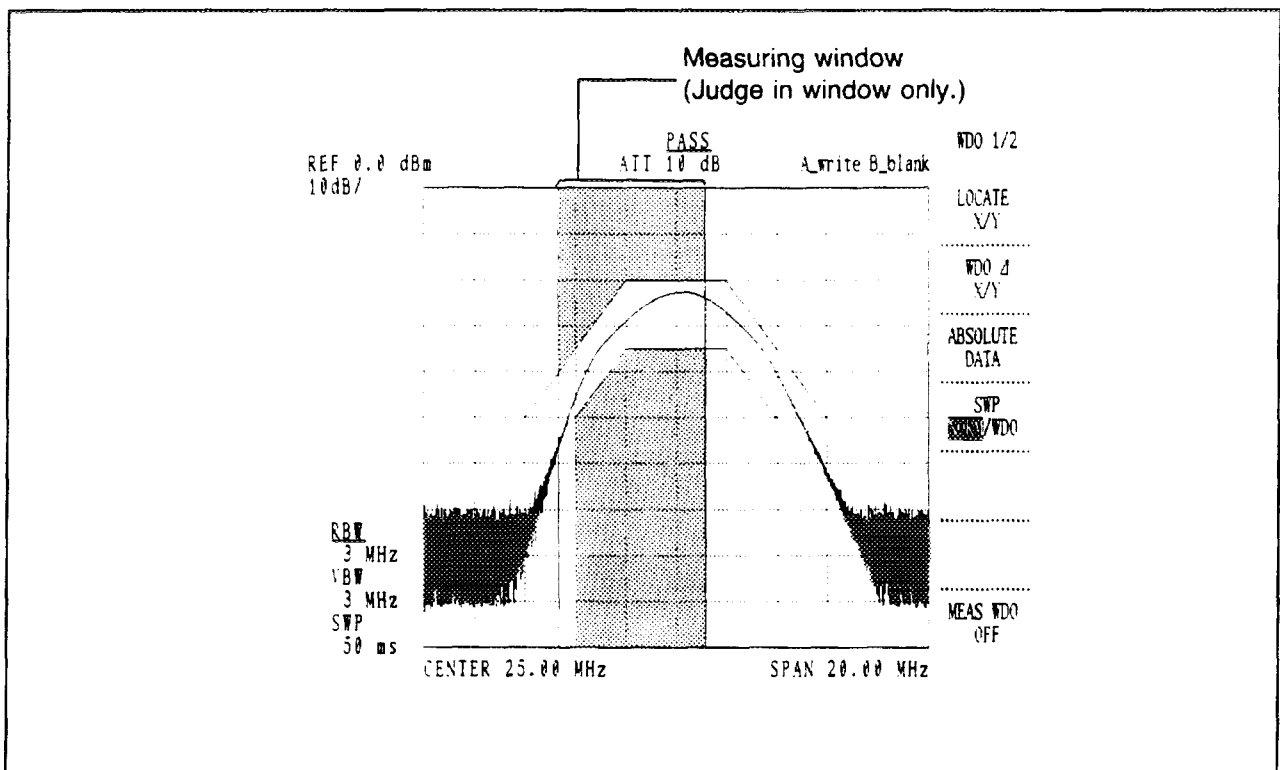

Figure 5.20-3 Judgment Range when Measuring Window is ON

(4) GPIB remote programming

GPIB command	Contents
PFC CN PFC OFF PFC?	Turn continuous mode on. Turn continuous mode off. Turn continuous mode on/off.
PFJ A PFJ B PFJ?	Judges trace A. Judges trace B. Reads out the judgment result.
OPF?	Reads out details of judgment result. 0: PASS 1: UPPER 2: LOWER 3: UPPER & LOWER 4: ERROR
FPU? FPL?	Outputs the upper FAIL point binary. Outputs the upper LOWER point binary.

The PASS/FAIL returned value when using the GPIB (same as measuring window comparator) is as follows:

FAIL : 0
PASS : 1

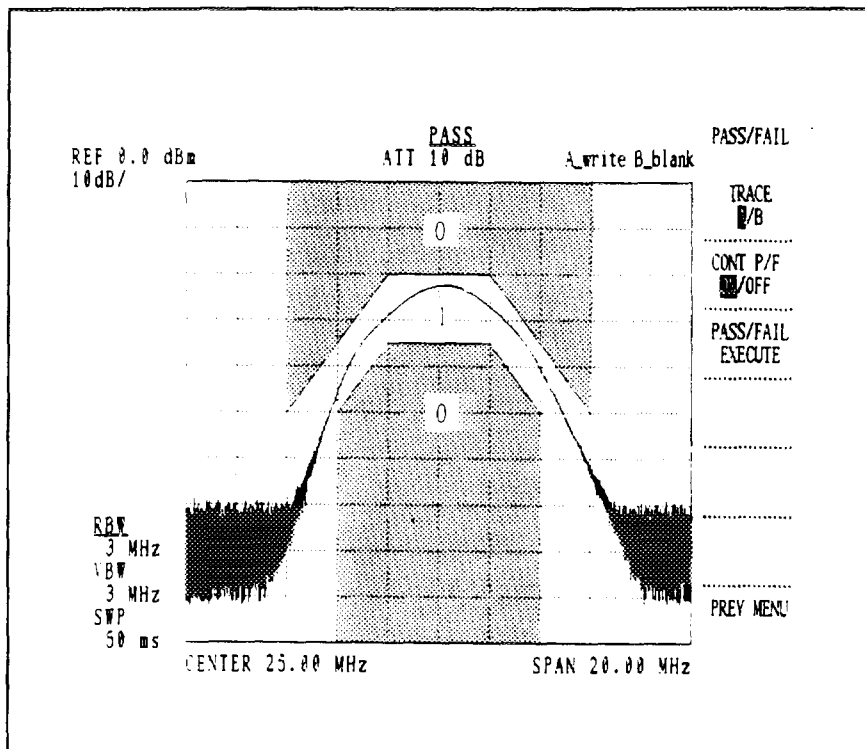

Figure 5.20-4 PASS/FAIL returned value

In the GPIB, this returned value is returned using a PFJ? command. When a subsequent returned value is requested (FAIL is at the UPPER or LOWER side), another command OFF? is used.

The FAIL point is returned individually at the UPPER side and the LOWER side. The point value indicates the f axis (0 to 700).

GPIB command returning FAIL point

FPU?

FPL?

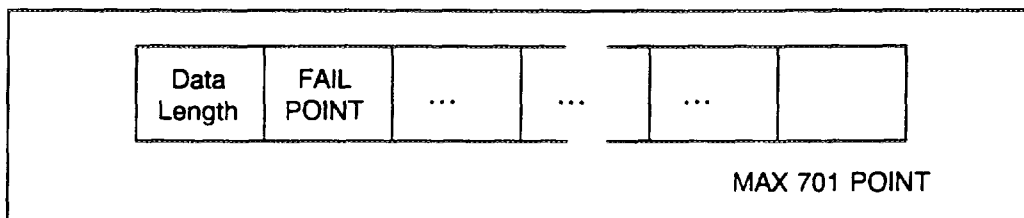

Example of HP200/HP300 series program

```
10     DIM Fpu(701),Fp1(701)
20     Spa=708
30     Pf$(0)="FAIL"
40     Pf$(1)="PASS"
50     Re$(1)="UPPER"
60     Re$(2)="LOWER"
70     Re$(3)="UP&LOW"
80     Re$(4)="ERROR"
90     !
100    OUTPUT Spa;"DL3"
110    OUTPUT Spa;"TS PFJ A"
120    OUTPUT Spa;"PFJ?"
130    ENTER Spa;J1
140    OUTPUT Spa;"OPF?"
150    ENTER Spa;J2
160    Pfu(0)=0
170    Fp1(0)=0
180    PRINT "JUDGEMENT ",Pf$(J1)
190    IF J1=0 THEN
200        PRINT "RESULT      ",Re$(J2)
210    !
220    !
230        IF BIT(J2,0) THEN GOSUB Fail_up
240        IF BIT(J2,1) THEN GOSUB Fail_low
250        PRINT "UPPER FAIL POINT",Fpu(0)
260        PRINT "LOWER FAIL POINT",Fp1(0)
270    END IF
280    STOP
290    Fail_up: !
300        OUTPUT Spa;"DL2 FPU?"
310        ENTER Spa USING "%,W";Fpu(*)
320        RETURN
330    Fail_low: !
340        OUTPUT Spa;"DL2 FPL?"
350        ENTER Spa USING "%,W";Fp1(*)
360        RETURN
370    !
380    END
```

Explanation of programs

```
10
to   Initial setting
80
100  Delimiter setting
110  After TAKE SWEEP, judge PASS/FAIL of trace A.
120  Specify PASS/FAIL judgment output.
130  Store judgment result to variable J1.
140  Specify output of detailed PASS/FAIL judgment result.
150  Store detailed output result to variable J2.
160  Clear number of upper FAIL point.
170  Clear number of upper FAIL point.
180  Output judgment result on screen

190  If judgment result is FAIL, process THEN and after.
200  Output FAIL result on screen

230  When FAIL result is upper limit line, go to Fail_up.
240  When FAIL result is lower limit line, go to Fail_low.
250  Output number of FAIL point in upper limit line.
260  Output number of FAIL point in lower limit line.

290  Fail_up:
300  Switch delimiter and specify output of upper FAIL point.
310  Store number of FAIL point (2 bytes) to array variable Fpu.
320  Complete subroutine.

330  Fail_low:
340  Switch delimiter and specify output of lower FAIL point.
350  Store number of FAIL point (2 bytes) to array variable Fpl.
360  Complete subroutine.
```

5.21 Adjacent Channel Leakage Power Measurement Function with Attached Root Nyquist Filter

This function is added to the "Adjacent Channel Leakage Power Measurement Function" of the R3265/3271. When measuring the adjacent channel leakage power, the value compensated using the root nyquist filter can be obtained.

- (1) Menu for adjacent channel leakage power measurement function with attached root nyquist filter

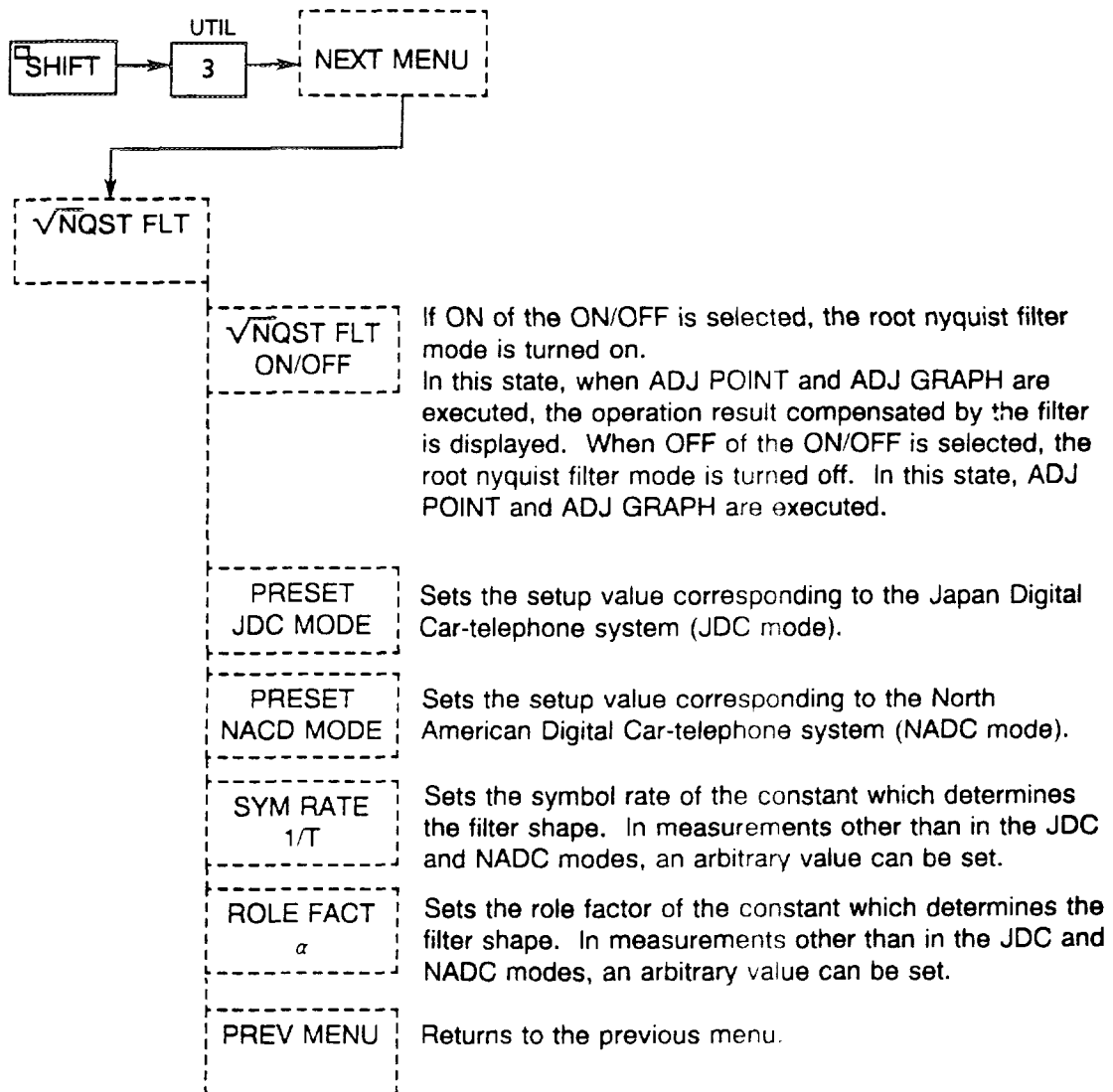

5.21 Adjacent Channel Leakage Power Measurement Function with Attached Root Nyquist Filter

(2) Executing ADJ POINT in NADC mode

- ① In the same way as for normal adjacent channel leakage power measurement (ADJ), set the marker to the specified channel frequency.

Press the keys in the order ON , 9 0 2 , MHz .

- ② The Adjacent channel leakage power measurement mode starts, and the channel span can be specified.

Press the keys in the order SHIFT , UTIL 3 ADJ SETUP
CH SP/BS , 4 0 .
2 , kHz .

(Setting of the standard bandwidth is not required.)

- ③ Set the NADC mode.

Press the keys in the order NEXT MENU , \sqrt{N} QST FLT , PRESET
NADC MODE .

($1/T = 24.3\text{kHz}$ and $\alpha = 0.35$ are set automatically.)

- ④ Turn the root nyquist filter mode on.

Turn the root nyquist filter mode on.

Press \sqrt{N} QST FLT
ON/OFF to set to ON.

- ⑤ When ADJ POINT is executed, the operation result compensated by the filter is obtained.



Press the keys in the order PREV MENU , PREV MENU , ADJ
POINT .

($1/T = 24.3\text{kHz}$ and $\alpha = 0.35$ are set automatically.)

5.21 Adjacent Channel Leakage Power Measurement Function with Attached Root Nyquist Filter

(3) Executing ADJ GRAPH in NADC mode

- ① Set the NADC mode.

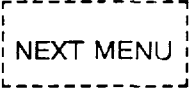
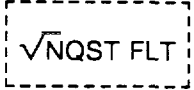
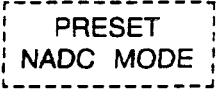
Press the keys in the order , , , ,
.

($1/T = 24.3\text{kHz}$ and $\alpha = 0.35$ are set automatically.)

- ② When ADJ GRAPH is executed, the operation result compensated by the filter is obtained.

Press the keys in the order , , .

5.21 Adjacent Channel Leakage Power Measurement Function with Attached Root Nyquist Filter

(4) Contents in operation

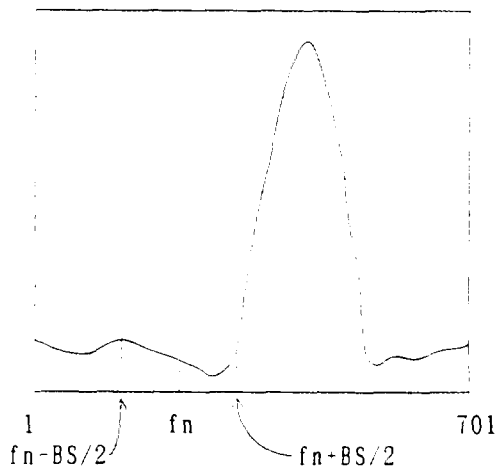

If the power is regarded as $p(f)$ on the screen above, the power P of the total bandwidth on 701 point is expressed below as f_1 = start frequency, f_{701} = stop frequency.

$$P = \int_{f_1}^{f_{701}} p(f) df \quad \dots \quad \textcircled{1}$$

The normal adjacent channel leakage power (ADJ) on the frequency = f_n is expressed by the following equation $\textcircled{2}$ as BS is the standard bandwidth.

$$\text{Standard ADJ} = 10 \times \log \left(\int_{f_n - BS/2}^{f_n + BS/2} p(f) df / P \right) \quad \dots \quad \textcircled{2}$$

The other ADJ with the root nyquist filter on the frequency = f_n is expressed by the following equation $\textcircled{3}$ as root nyquist filter characteristics.

$$\text{ADJ with root nyquist filter} = 10 \times \log \left(\int_a^b p(f) H^2(f - f_n) df / P \right)$$

However, $a = f_n - (1 + \alpha)/1T$, $b = f_n + (1 + \alpha)/2T$, $a \geq$ start frequency, and $b \leq$ stop frequency are defined. The $H(f)$ is 0 other than the integral area. Refer to "(5)".

Since the integral in the expression $\textcircled{3}$ is the electric power domain, the square of $H(f - f_n)$ and the integral of the $p(f)$ product are total sum of the electric power through the filter.

(5) Shape of root nyquist filter

1/T : Symbol rate

 α : Role factorThe root nyquist filter $H(f)$ is expressed by the following equation.

$$|H(f)| = \begin{cases} 1 & 0 \leq |f| \leq (1-\alpha)/2T \\ \text{COS}[(T/4\alpha)(2\pi|f| - \pi(1-\alpha)/T)] & (1-\alpha)/2T \leq |f| \leq (1+\alpha)/2T \\ 0 & (1+\alpha)/2T \leq |f| \end{cases}$$

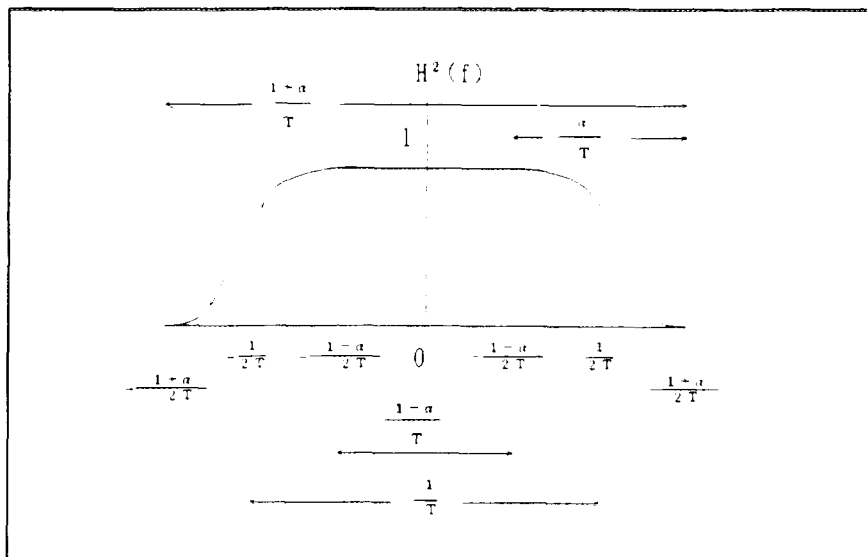
The shape of $H^2(f)$ is as follows:

5.21 Adjacent Channel Leakage Power Measurement Function with Attached Root Nyquist Filter

(6) GPIB remote programming

GPIB command	Contents
NQST ON	Turns the root nyquist filter on.
NQST OFF	Turns the root nyquist filter off.
NQST?	Reads out the ON/OFF state of the root nyquist filter mode.
NQST JDC	Sets the parameter corresponding to the JDC mode.
NQST NADC	Sets the parameter corresponding to the NADC mode.
BRATE Frequency	Sets the symbol rate.
BRATE?	Reads out the data of the symbol rate.
RFCT Numeric	Sets the role factor.
RFCT?	Reads out the data of the role factor.

Example of HP200, 300 series programs

Turn the root nyquist filter on to measure ADJ POINT.

```

10     OUTPUT 708;"CF900MZ; SP200kZ; TDS"
20     OUTPUT 708;"PS"
30     OUTPUT 708;"NQST JDC"
40     OUTPUT 708;"NQST ON"
50     OUTPUT 708;"HDO; ADJ?"
60     OUTPUT 708;"ADCH50kZ; ADJ"
70     ENTER 708;Up,Lo
80     PRINT Up,Lo
90     END

```

Explanation of programs

```

10     Set the frequency and turn the detector to SAMPLE.
20     Execute the peak search. (Set the marker to the channel frequency.)
30     Set to the JDC mode (same as when "BRATE21KZ; RFCT0.5ENT" is set instead of "NQST
      JDC").
40     Turn the root nyquist filter on.
50     Turn the header off and specify the output data to ADJ POINT.
60     Specify the channel span (CH SP) as 50 kHz and execute the ADJ point.
70     Output the measurement data.

```

5.22 Alternated Modulation Distortion Measurement Function

(1) Measuring alternated modulation distortion

Measure the relative value (frequency and level difference) between the signal and its three-dimensional distortion. After execution, display the delta marker and the active marker individually for the signal and three-dimensional distortion, and the result as the delta marker value will be displayed in the marker area.

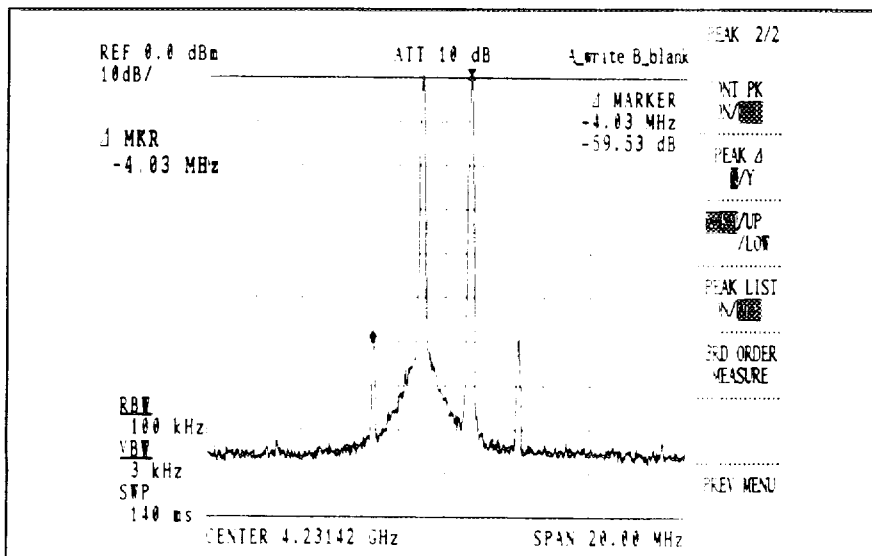

The waveform in the window is measured by turning the measuring window (SHIFT → 0 key) on.

In the same way as for the NEXT PK function, the setting values of ΔX and ΔY are related.

(2) Menu for alternated modulation distortion measurement function

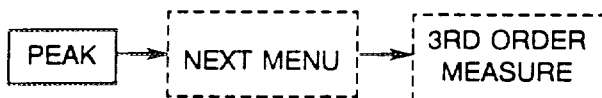

CAUTION

In three-dimensional distortion, the active marker moves to the higher level.

(3) GPIB remote programming

GPIB command	Contents
PKTHIRD	Perform the alternated modulation distortion.

Example of HP200, 300 series programs

10	OUTPUT 708;"H00 PKTHIRD"	'Execute the header OFF and this function.
20	OUTPUT 708;"MFL?"	'Specify the output of marker frequency, level output.
30	ENTER 708;Mf,M1	'Read out data.
40	PRINT Mf,M1	'Display
50	END	

6. GPIB: REMOTE PROGRAMMING

The R3265A/3271A analyzer includes a general-purpose interface bus (GPIB) that enables you to run the analyzer from a remote controller or computer. This chapter explains how to do this.

6.1 Overview of the GPIB

You can control the R3265A/3271A analyzer with any remote controller or computer that uses an IEEE Standard 488-1978 (GPIB) interface. This enables you to run the analyzer remotely, and to use the analyzer to run fully or partially automated tests.

You can use the GPIB controller to do the following:

- ① Set measurement conditions (enter the measurement conditions as you would from the front panel)
- ② Read (or query) existing settings and data
- ③ Send and receive measurement data (including screen trace, data write, and read out)
- ④ Send service requests to the controller (this interrupts the controller's current task and reads the status byte)

The analyzer's GPIB is fully compatible with any product that meets the IEEE 488-1978 standard. The GPIB bus allows you to connect the analyzer to other GPIB devices more easily than you can using single bus cables, making it easier to construct or modify high-grade measuring systems.

Each device on the GPIB can be assigned the role of controller, talker (sender), or listener (receiver). Devices commonly change roles while the system is operating, although there can only be one controller. Only one device can "talk" at a time, though multiple devices can "listen." The controller specifies the talker and listener addresses and transfers data from the talker to the listener. The controller itself can also play the role of talker, and can specify listener measurement conditions.

GPIB panel switches

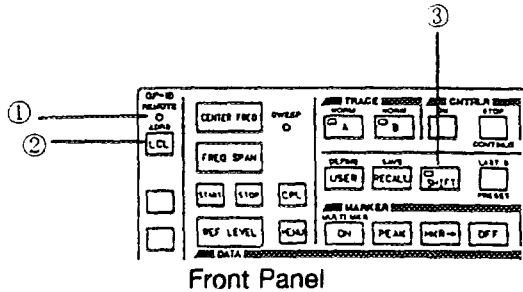

Front Panel

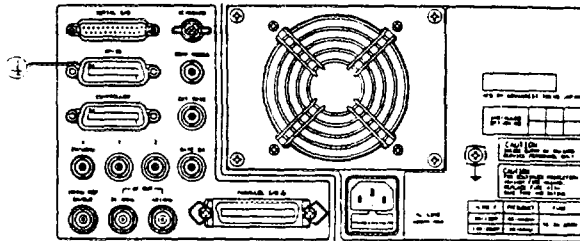

Rear Panel

- ① Remote lamp
This lamp lights when the analyzer is set to External control mode.
- ② LCL key
This key switches the analyzer between Remote and Local control (allowing you, for example, to interrupt external control and enable input from the front panel).
- ③ SHIFT key
This key, with the LCL key, specifies the GPIB address.
- ④ GPIB connector
This terminal connects the analyzer to the external controller or to a plotter.

6.2 GPIB Specifications

(1) GPIB Bus. The following figure shows the configuration of a typical GPIB system, in this case with four devices.

The GPIB bus cables include eight data lines, three transfer control lines (handshake lines), and five bus control lines. These lines function as follows:

- Data lines: these bit-parallel, byte-serial data lines provide asynchronous, bi-directional data transfer between devices. This allows the GPIB system to use high-speed and low-speed at the same time. Data is transferred as ASCII code.
- Transfer control lines (handshake lines) : these control the asynchronous data transfer between devices, and use the following signals:

DAV (Data valid) : indicates the data valid state (low state)

NRFD (Not ready for data) : indicates that data can (high state) or cannot (low state) be received

NDAC (Not data accepted) : indicates that data has (high state) or has not (low state) been received

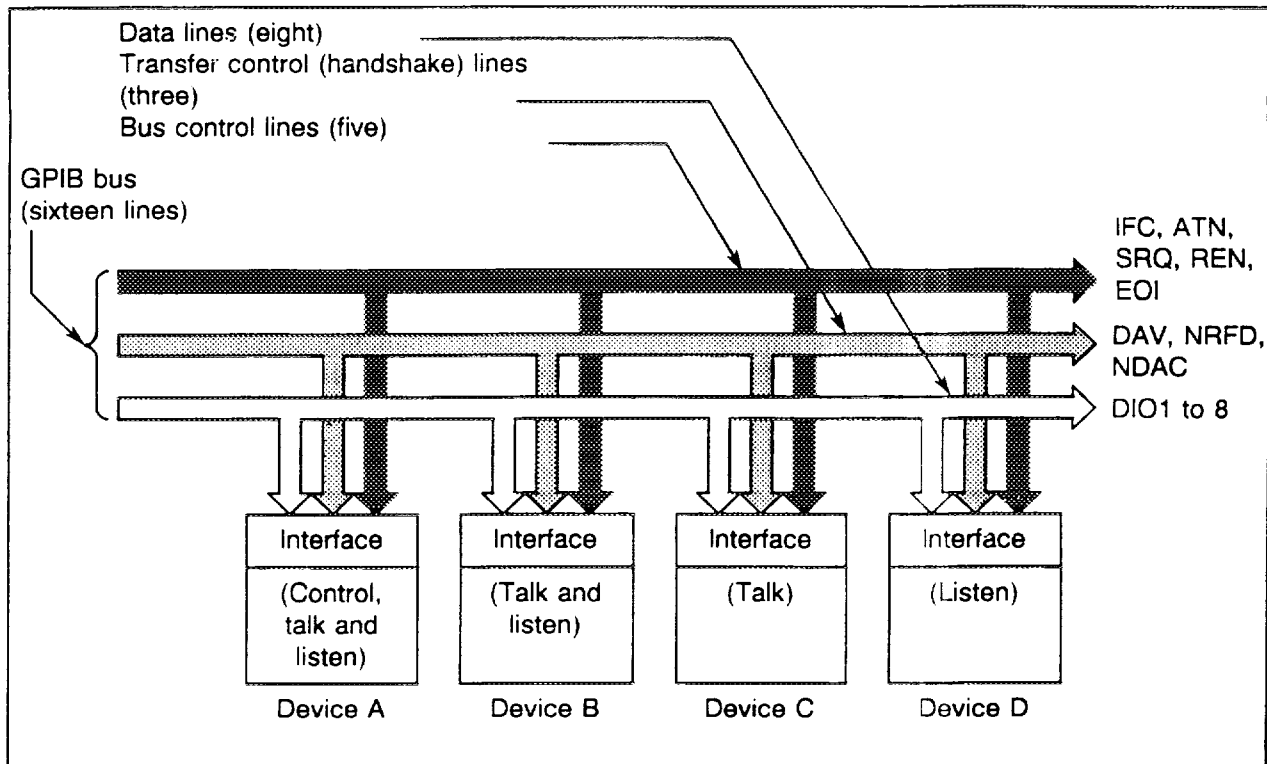

Figure 6.1-1 GPIB Bus Configuration

- **Bus control lines:** these control the flow of information through the bus, and use the following signals:
 - ATN (Attention):** determines whether the signal on the data line is a command or other information
 - IFC (Interface clear):** clears the interface
 - EOI (End of identify):** signals the completion of information transfer
 - SRQ (Service request):** makes a service request to the controller
 - REN (Remote enable):** enables remote control of a device
- (2) **Connector:** The analyzer has a 24-pin GPIB connector, Amphenor product number 57-20240-D35A or its equivalent. The following figure shows the connector and its pin assignments.

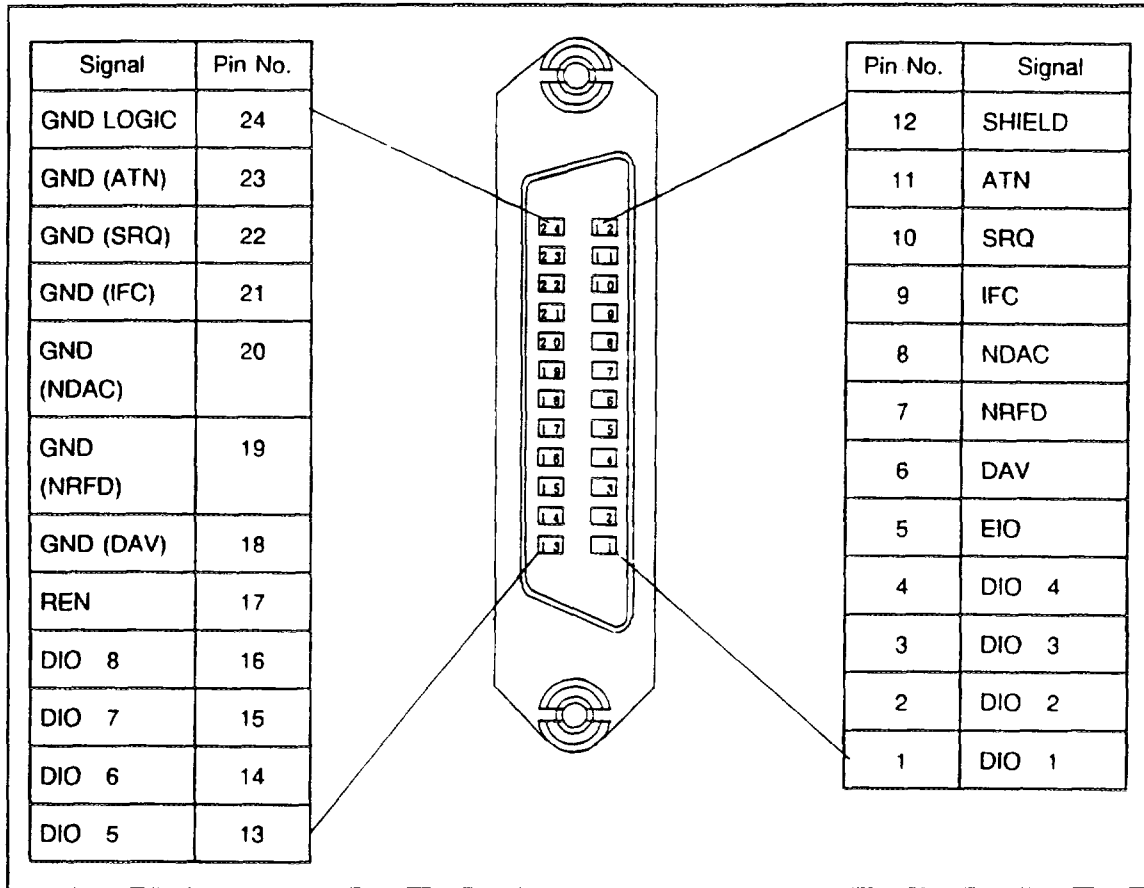

Figure 6-2 GPIB Connector Pin Assignment

(3) Specifications

- Code : ASCII, except for packed formatting (which uses binary code)
- Logic level : Logical 0 High state +2.4 V or above
Logical 1 Low state +0.4 V or below
- Signal line termination : all sixteen bus lines are terminated as shown below.

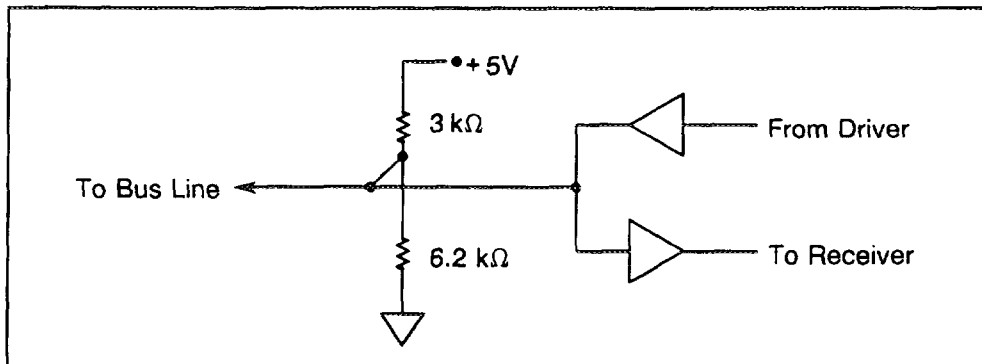

Figure 6-3 Signal Line Termination

- Driver : Open collector type
Output voltage at Low ... +0.4 V or below, 48 mA
at High.... +2.4 V or above, - 6.2 mA
- Receiver : + 0.6 V or below ... "Low" state
+ 2.0 V or above ... "High" state
- Bus cable length : Connect one device for every four meters of cable you use. The total length of cable connected to the bus must be less than 20 meters.
- Addresses : Assign a unique talk/listen address (0 through 30) to each device on the bus using the front panel keys. Each device on the bus must have a unique address.

(4) Interface Function: Table 6-1 describes the GPIB codes used by the analyzer.

Table 6-1 Analyzer GPIB Interface Codes

Code	Description
SH1	Source handshake function
AH1	Acceptor handshake function
T6	Basic talker function, Serial pole function, Talker cancel function by listener specification
L4	Basic listener function, Listener cancel function by talker specification
SR1	Service request function
RL1	Remote function
PP0	No parallel function
DC1	Device clear function provided
DT1	Device trigger function provided
C0	No controller function
E1	Used open collector bus driver; however, EOI and DAV is used a three state bus driver.

6.3 Initializing the Analyzer

Before you use the analyzer with a GPIB system, you must initialize it as described below.

6.3.1 Setting the Analyzer's GPIB Address

Set the analyzer's GPIB address (0 through 30) using front panel keys.

Example: To set the analyzer's GPIB address to 1:

Press SHIFT LCL 1 GHz .

6.3.2 Defining the Delimiter

When sending data from a controller to the analyzer, use one of the delimiter codes described below to define the symbol that will be used as a message terminator: carriage return (CR), line feed (LF), or end or identify (EOI). When the analyzer sends data to the controller, one of the delimiters given below is selected.

Table 6-2 Delimiter Specification Codes

Code	Description
DL0	Outputs CR and LF, also outputs EOI signal together with LF
DL1	Outputs LF
DL2	Outputs EOI signal together with the data end byte
DL3	Outputs CR and LF (initial value)
DL4	Outputs LF and also EOI signal together with LF

6.4 Command Syntax (Listener)

This section describes the syntax you must use to send GPIB commands to the analyzer.

The general syntax for a command is this:

`<command> <separator> <device address>;<data>`

Where:

- `<command>` is the code for the command you want to use. Section 6.8 lists all GPIB command codes available for the analyzer.
- `<separator>` is a space or a comma. All commands must be separated by a space or a comma:
CF SP -- Correct
CFSP -- Incorrect
- `<data>` is the data associated with the command. Note that numeric data do not need to be separated from commands:
CF 300 MZ -- Correct
CF300MZ -- Correct

When sending commands you must also obey the following restrictions:

- Do not use binary numbers (excluding the trace binary input).
- Use the carriage return (CR) and line feed (LF) as data delimiters.
- Do not enter data that is not specifically defined as a GPIB code or a syntax error will occur.

Sections 6.4 through 6.7 give programming examples using the HP200 or 300 series computers manufactured by Hewlett-Packard. Read your computer manual for specific information about applying these examples to your system. In these examples, note that each program line that uses a command also specifies the GPIB address of the device the command is being sent to. These examples also assume the analyzer has been initialized.

For example, to set the analyzer's center frequency to 300 MHz, you would send the following:

OUTPUT	7	01	;	"CF	300MZ"		*1	Specifies the controller as the talker
	↑			↑	↑		*2	GPIB interface selector
							*3	Specifies the analyzer (GPIB address
							*4	01) as the listener
							*5	Sets the center frequency active
								Sets the center frequency to 300 MHz

In these examples, "CF" and "MZ" are GPIB command codes. See Section 6.8 for a complete list of GPIB codes.

HP200 and 300 series programming examples (GPIB address = 1)

<p>Example 6-1: Reset the analyzer master key and set the center frequency to 25 MHz.</p>	
<pre>10 OUTPUT 701;"IP" 20 OUTPUT 701;"CF25MZ" 30 END</pre>	
<p>Example 6-2: Set the start and stop frequencies to 300 kHz and 800 kHz, respectively, and add 50 kHz to the frequency offset.</p>	
<pre>10 OUTPUT 701;"FA300KZ" 20 OUTPUT 701;"FB800KZ" 30 OUTPUT 701;"FON50KZ" 40 END</pre>	
<p>Example 6-3: Set the reference level to -20 dBm (5 dB/div), resolution bandwidth to 100 kHz, and detector mode to positive.</p>	
<pre>10 OUTPUT 701;"RE-20DB" 20 OUTPUT 701;"DD5DB" 30 OUTPUT 701;"RB100KZ" 40 OUTPUT 701;"DTP" 50 END</pre>	
<p>Example 6-4: Set the trigger mode to Single and the sweep time to 2 seconds, and match the marker with the maximum level at each sweep.</p>	
<pre>10 OUTPUT 701;"SI" 20 OUTPUT 701;"SW2SC" 30 OUTPUT 701;"SR" 40 WAIT 2.5 50 OUTPUT 701;"PS" 60 GOTO 30 70 STOP 80 END</pre>	<p>! Starts the sweep.</p> <p>! Pauses the analyzer until the sweep ends (or a service request is received).</p> <p>! Performs a peak search.</p>
<p>Example 6-5: Set MAX HOLD (A)</p>	
<pre>OUTPUT 701;"AM"</pre> <p>or</p> <pre>OUTPUT 701;"TA SF4"</pre>	<p>! Sets MAX HOLD (A) directly.</p> <p>! Sets MAX HOLD (A) using a Softkey. ! (Trace A → Softkey No.4)</p>

Example 6-6: Recall channel 5.

OUTPUT 701"RN"	! Switches to NORMAL mode.
OUTPUT 701;"RC 5 GZ SF1"	! Recalls channel 5. (SF1 is EXECUTE soft key.)
or	
OUTPUT 701;"RF"	! Switches to FAST mode.
OUTPUT 701;"RC 5"	! Recalls channel 5.

6.5 Query Syntax (Talker)

This section describes the syntax to use when requesting information from the analyzer (or "querying" the analyzer) from the GPIB controller, and the syntax the analyzer uses when returning information in response to a query.

All queries have the form `<query>?`, where `<query>` is the code for the query you want to use. Note that all queries must end with a question mark.

The data you request (also called the response) is returned to the controller the next time the analyzer enters Talker mode. The response has one of the formats shown below. Each format puts a header at the beginning of the character string to show what type of data the response contains. (These headers can be omitted.) You can use any of five delimiters to mark the end of the data (see Section 6.8). The query you send is valid unless you modify it.

The following table shows the five response formats, and shows a typical response using each. (In each of these examples the header is ON.)

- Notes:
- 1 = Header character (2 or 3 characters if ON, and no characters if OFF)
 - 2 = Separator (a space)
 - 3 = Sign (a space if positive, a minus sign if negative)
 - 4 = Delimiter mantissa
 - 5 = Delimiter exponent
 - 6 = Delimiter (at initial setting)

	Response Format
Frequency	$HHH\Delta \pm DDDDDDDDDDE \pm D \text{ CR LF}$ $\begin{matrix} \uparrow & \uparrow & \uparrow & & \uparrow & & \uparrow & & \uparrow \\ 1 & 2 & 3 & & 4 & & 5 & & 6 \end{matrix}$ Maximum data size (including 1 through 5) is 21 bytes; the unit is Hz. Example: Sending the query CF? might return the response CF 00000123.456E + 6 This shows that the center frequency is 123.456MHz.
Level	$HHH\Delta \pm DDDDDDDDE \pm D \text{ CR LF}$ $\begin{matrix} \uparrow & \uparrow & \uparrow & & \uparrow & & \uparrow & & \uparrow \\ 1 & 2 & 3 & & 4 & & 5 & & 6 \end{matrix}$ Maximum data size (from 1 through 5) is 16 bytes; the units specified by UNIT are used. Example: Sending the query ML? might return the response MLB -00056.23E + 0 This shows a marker level of -56.23dBm.
Time	$HH\Delta \pm DDDDE \pm D \text{ CR LF}$ $\begin{matrix} \uparrow & \uparrow & \uparrow & & \uparrow & & \uparrow \\ 1 & 2 & 3 & & 4 & & 5 & & 6 \end{matrix}$ Maximum data size (from 1 through 5) is 11 bytes; the unit is seconds. Example: Sending the query SW? might return SW 0500E-3, showing a sweep time of 500 msec.
Constant	$DDDD \text{ CR LF or } DDDD.D$ $\begin{matrix} \uparrow & & \uparrow \\ 4 & & 6 \end{matrix}$ Example: Output the ON/OFF state. Output the number of averagings. 1/0 128

HP200 and 300 series programming examples (GPIB address = 1).

Example 6-7: Output the marker frequency.	
10 OUTPUT 701;"MF?"	
20 ENTER 701;A	
30 END	Result: A = 1.8E + 9
Example 6-8: Output the center frequency.	
10 DIM A\$ (30)	
20 OUTPUT 701;"HD1"	
30 OUTPUT 701;"CF?"	
40 ENTER 701;A\$	
50 END	Result: A\$ = CF 00001.234567E + 9
Example 6-9: Output the unit state.	
10 OUTPUT 701;"UN?"	
20 ENTER 701;A	
30 END	Result: A = 2 (dB μ V)
Example 6-10: Output the marker frequency and level.	
10 OUTPUT 701;"MFL?"	
20 ENTER 701;Mf,M1	
30 END	Result: Mf = 1.8E + 9 M1 = - 65.15
Example 6-11: Output the frequency offset.	
10 OUTPUT 701;"FO?"	
20 ENTER 701;On,Frq	
30 END	Result: On = 1 Frq = 1.23E + 6
Example 6-12: Using NEXT PEAK, read the first 10 signal peak levels, starting at the second peak.	
10 DIM M1(9)	
20 OUTPUT 701;"PS"	
30 FOR I = 0 TO 9	
40 OUTPUT 701;"NXP"	
50 OUTPUT 701;"ML?"	
60 ENTER 701;M1(I)	
70 NEXT I	
80 END	Result: M1(0) = - 55.01 M1(1) = - 58.22 M1(9) = - 70.26

6.6 Inputting and Outputting Trace Data

The trace displayed on the screen is made up of 701 data points plotted along the frequency axis. When entered into or read out of trace memory A or B, the data is transferred one point at a time, starting at the left end of the trace (the start frequency). Trace data can be sent and received in either ASCII or binary form. The level of each point is expressed as an integer from 0 to 400 (in TPC format) or from 448 to 3648 (in TPF format).

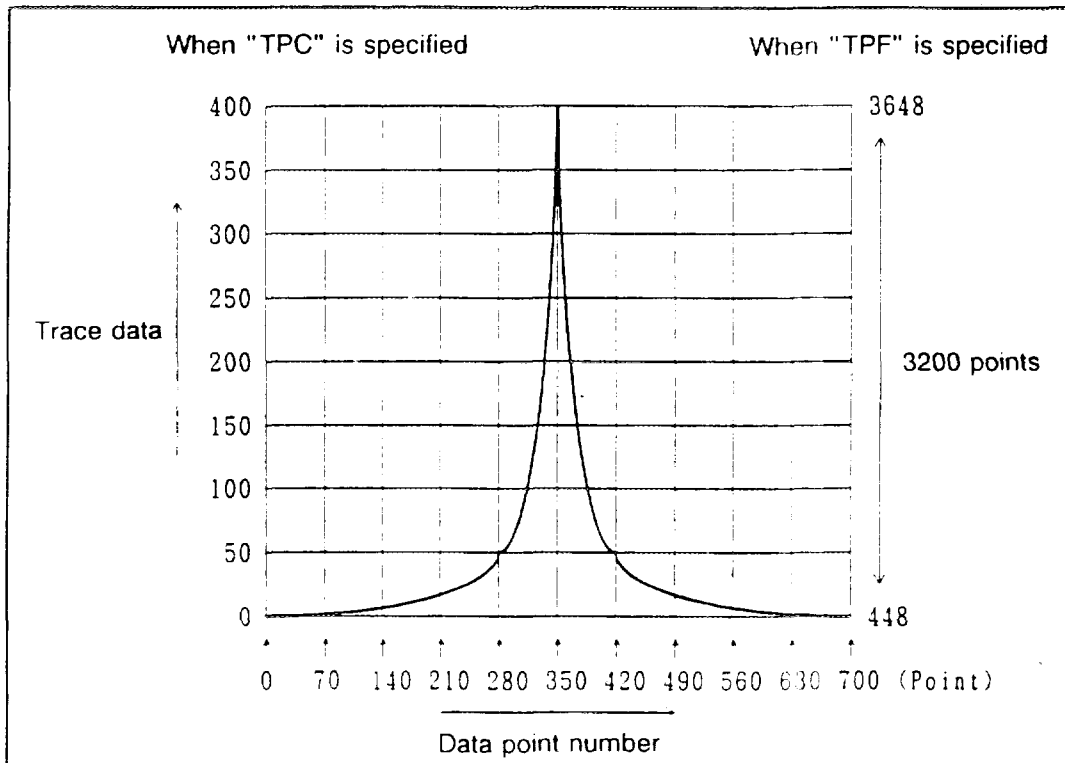

Figure 6-4 Relation Between Screen Grid and Data Points

Table 6-3 shows the GPIB commands used to select TPC or TPF format.

Table 6-3 Trace Accuracy Commands

Command	Contents
TPC	Input/output the trace data at the accuracy of 0 to 400.
TPF	Input/output the trace data at the accuracy of 448 to 3648.

The following table shows the commands, queries, and syntax used for sending and receiving trace

I/O Format	Syntax and Command Codes									
ASCII	<p style="text-align: center;"> <u>DDDD</u> CR LF ↑ ↑ Data of Delimiter one point </p> <p style="text-align: center;">4-byte Data Without Header</p> <table border="1" style="margin-left: auto; margin-right: auto; border-collapse: collapse;"> <thead> <tr> <th style="width: 33%;"></th> <th style="width: 33%;">Command (Input) Code</th> <th style="width: 33%;">Query (Output) Code</th> </tr> </thead> <tbody> <tr> <td style="text-align: center;">Memory A</td> <td style="text-align: center;">TAA</td> <td style="text-align: center;">TAA?</td> </tr> <tr> <td style="text-align: center;">Memory B</td> <td style="text-align: center;">TAB</td> <td style="text-align: center;">TAB?</td> </tr> </tbody> </table>		Command (Input) Code	Query (Output) Code	Memory A	TAA	TAA?	Memory B	TAB	TAB?
	Command (Input) Code	Query (Output) Code								
Memory A	TAA	TAA?								
Memory B	TAB	TAB?								
Binary	<p style="text-align: center;"> <u>DD DD</u> <u>DD DD</u> + EOI ↑ ↑ ↑ Point 1 lower byte Delimiter ↑ ↑ ↑ ↑ Point 1 upper byte Point 701 lower byte ↑ ↑ Point 701 upper byte </p> <p style="text-align: center;">The binary value of each data point consists of an upper byte and a lower byte. The EOI signal marks the end of the data.</p> <table border="1" style="margin-left: auto; margin-right: auto; border-collapse: collapse;"> <thead> <tr> <th style="width: 33%;"></th> <th style="width: 33%;">Command (Input) GPIB Code</th> <th style="width: 33%;">Query (Output) Code</th> </tr> </thead> <tbody> <tr> <td style="text-align: center;">Memory A</td> <td style="text-align: center;">TBA</td> <td style="text-align: center;">TBA?</td> </tr> <tr> <td style="text-align: center;">Memory B</td> <td style="text-align: center;">TBB</td> <td style="text-align: center;">TBB?</td> </tr> </tbody> </table>		Command (Input) GPIB Code	Query (Output) Code	Memory A	TBA	TBA?	Memory B	TBB	TBB?
	Command (Input) GPIB Code	Query (Output) Code								
Memory A	TBA	TBA?								
Memory B	TBB	TBB?								

data to and from the analyzer.

You can control the range of the trace data the analyzer returns by specifying the first data point and the total number of data points you want. To do this, use the command syntax shown in the following diagram.

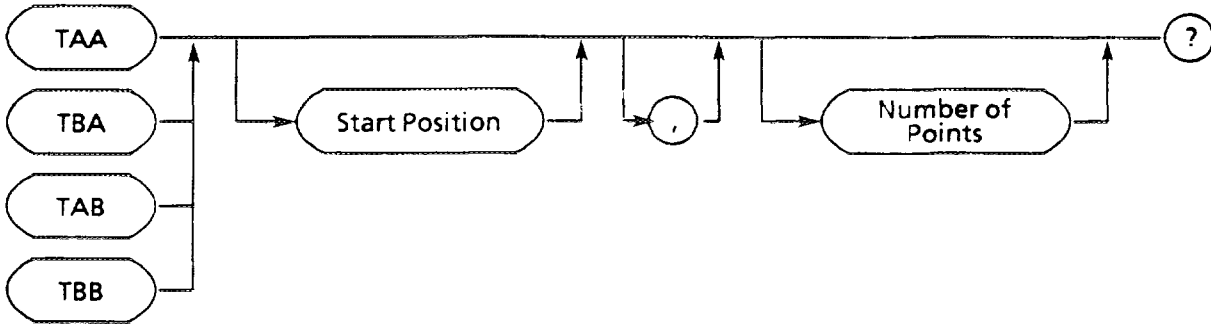

- Start Position specifies the first data point you want output (0 through 700). The default value is 0.
- Number of Points specifies the total number of data points you want output. This number must not be larger than (701-Start Position). The default value is 701.

HP200 and 300 series programming examples (GPIB address = 1)

Example 6-13: Output ASCII data from memory A.	
<pre> 10 DIM Tr(700) 20 OUTPUT 701;"DL3" 30 OUTPUT 701;"TAA?" 40 FOR I=0 TO 700 50 ENTER 701;Tr(I) 60 NEXT I 70 END </pre>	<pre> ! Fetches 701 variables. ! Specifies CR LF as the delimiter. ! Specifies that data will be read from memory A in ! ASCII format. ! Fetches data 701 times. </pre> <p style="text-align: center;">Result: Tr(0) = 208 Tr(1) = 210...Tr(699) = 311 Tr(700) = 298.</p>
Example 6-14: Output binary data from memory B.	
<pre> 10 DIM Tr(700) 20 OUTPUT 701;"DL2" 30 OUTPUT 701;"TBB?" 40 ENTER 701 USING "%,W";Tr(*) 50 END </pre>	<pre> ! Fetches 701 variables. ! Specifies EOI as the delimiter. ! Specifies that data will be read from memory B in ! ASCII format. ! Fetches data through word conversion until the EOI ! is received. </pre> <p style="text-align: center;">Result: Tr(0) = 312 Tr(1) = 319...Tr(699) = 208 Tr(700) = 211.</p>
Example 6-15: Input ASCII data to memory A.	
<pre> 10 INTEGER Tr(700) 20 OUTPUT 701;"TAA" 30 FOR I=0 TO 700 40 OUTPUT 701;Tr(I) 50 NEXT I 60 END </pre>	<pre> ! Specifies that data will be read from memory A in ! ASCII format. ! Inputs 701 variables. </pre> <p style="text-align: center;">Note: Specify VIEW mode before executing the program. After execution is complete, press the VIEW key again to confirm the input result.</p>

HP200 and 300 series programming examples (GPIB address = 1).

Example 6-16: Input binary data to memory B.

```
10 INTEGER Tr(700)
20 OUTPUT 701;"TBB"           ! Specifies binary data to be input to memory B.
30 OUTPUT 701 USING "#,W";Tr(*),END ! Inputs 701 data in word size and adds EOI at the
                                ! end.
40 END
```

Note: Specify VIEW mode before executing the program. After execution is complete, press the VIEW key again to confirm the input result.

Note: If the data is in ASCII format, specify 701 as the the number of I/O processings.

If the data is in binary format, fetch 701 data items and specify EOI as the delimiter.

6.7 Service Request (SRQ)

The service request function prompts the controller and other devices in the GPIB system to check the analyzer's state by polling the status register. Table 6-4 lists the codes used to enable and disable the SRQ function and to clear the status register. When SRQ is disabled, the controller can still poll the status register.

Table 6-4 Service Request ON/OFF Codes

GPIB code	Description
S0	Enables the SRQ function.
S1	Disables the SRQ function. (This is the default setting.)
S2	Clears the status register.

Table 6-5 Status Register Bit Assignments

Bit	Decimal	Description
0	1	Turns ON when UNCAL occurs.
1	2	Turns ON when calibration is complete.
2	4	Turns ON when a sweep is complete.
3	8	Turns ON when the specified number of averagings is complete.
4	16	Turns ON when plot output is complete.
5	32	Turns ON when an error is found in the GPIB code or a mode error occurs (SYNTAX ERR).
6	64	Turns ON when bits 0 through 5 or 7 when a service request is transmitted (S0).
7	128	

Table 6-5 lists the assignments of the bits in the status register. When any of the following conditions occurs, the corresponding status bit turns ON, and the controller can determine the analyzer's status by polling the status register.

HP200 and 300 series programming examples (GPIB address = 1).

Example 6-17: Read the average end. (SRQ is not enabled.)

```

10 OUTPUT 701;"S2"           ! Clears the status register.
20 OUTPUT 701;"AG 30GZ"      ! Starts averaging.
30 S = SPOLL(701)            ! Reads the status register into S.
40 IF BIT(S,3) < > 1 THEN 30 ! Loops until bit 3 turns ON.
50 DISP "AVG.END"
60 END

```

Example 6-18: Continuously read out the single sweep end. (SRQ is not enabled.)

```

10 OUTPUT 701;"S1"           ! Sets the mode to single.
20 OUTPUT 701;"S2"           ! Clears the status register.
30 OUTPUT 701;"SR"          ! Starts the sweep.
40 S = SPOLL(701)            ! Reads the status register into S.
50 IF BIT(S,2) < > 1 THEN 40 ! Waits until bit 2 turns ON.
60 PRINT "SWEEP END"
70 GOTO 20                   ! Starts the next sweep.
80 END

```

Example 6-19: Read out the average end. (SRQ is enabled.)

```

10 OUTPUT 701;"S0"           ! Enables SRQ.
20 OUTPUT 701;"S2"           ! Clears the status register.
30 OUTPUT 701;"AG"          ! Starts averaging.
40 ON INTR 7 GOTO 70         ! Jumps to line 70 when an interrupt occurs.
50 ENABLE INTR 7;2          ! Sets the analyzer to receive an interrupt.
60 GOTO 50                   ! Loops until an interrupt occurs.
70 S = SPOLL(701)            ! Reads the status register into S.
80 IF BIT(S,3) = 1 THEN 110 ! Jumps to line 110 if bit 3 is ON.
90 OUTPUT 701;"S2"          ! Clears the status register.
100 GOTO 40                  ! Repeats.
110 DISP "AVG.END"
120 END

```

6.8 GPIB Codes

The tables on the following pages list and explain the GPIB codes you can use to control the R3265A and R3271A.

- An asterisk (*) in the Listener Codes column indicates that you can send numeric data following that code by using a knob, ten key or step key.
- A plus sign (+) in the Output Formats column indicates that multiple data items are output.
- AUTO/MANUAL or ON/OFF in the Output Formats column indicates that the code outputs 1 or 0, respectively.
- ON/OFF in the Output Formats column indicates that they output 1 or 0, respectively.
- A star (☆) in the Remarks column indicates the initial value when power is turned on.
- The words "Knob alone" in the Remarks column indicate that you must use the data knob to enter numeric data after sending that code.
- All frequencies are in Hertz (Hz), and all times are in seconds or fractions of a second.

Function	Listener Code	Talker Request			Remarks	
		Code	Output Format	Header		
Center Frequency	Center Frequency	CENTER *	CENTER?	Frequency	CF	
		CF *	CF?	Frequency	CF	
	CF step size	CFSTEP *	CFSTEP?	Frequency	CS	
		CS *	CS?	Frequency	CS	
	CF step AUTO	CSAUTO	CSAUTO?	AUTO/MANUAL	—	
		CA	CA?	AUTO/MANUAL	—	
	Frequency offset	FROFS *	FROFS?	ON/OFF + Frequency	FO	
		FO *	FO?	ON/OFF + Frequency	FO	
	Frequency offset ON	FROFS ON *	—	—	—	
		FO ON *	—	—	—	
		FON *	—	—	—	
	Frequency offset OFF	FROFS OFF	—	—	—	
		FO OFF	—	—	—	
		FOF	—	—	—	
	Mixer state	—	MXR?	Internal (0)/ External (1)	—	
	Internal mixer	MXINT	—	—	—	
	MXI	—	—	—		

Function	Listener Code	Talker Request			Remarks
		Code	Output Format	Header	
Center Frequency	External mixer	MXEXT	—	—	—
		MXE	—	—	—
	Positive bias	MXPOSI *	MXPOSI ?	Level	MPX
		MPX *	MPX?	Level	MPX
	Negative bias	MXNEGA *	MXNEGA?	Level	MXN
		MXN *	MXN?	Level	MXN
	Band N	BND *	BND?	Integer	BND
	Band lock	—	BNDLC?	ON/OFF	—
	Band lock ON	BNDLC ON	—	—	—
	Band lock OFF	BNDLC OFF	—	—	—
	Signal ident	—	SIGID?	ON/OFF	—
	Signal ident ON	SIGID ON	—	—	—
	Signal ident OFF	SIGID OFF	—	—	—
	Avg. Loss mode	AGL*	AGL?	ON/OFF + Level	AGL
	Avg. Loss ON	AGL ON	—	—	—
	Avg. Loss OFF	AGL OFF	—	—	—
	Loss vs. Freq mode	—	LVF?	ON/OFF	—
	Loss vs. Freq ON	LVF ON	—	—	—
	Loss vs. Freq OFF	LVF OFF	—	—	—
	Loss vs. Freq input	LVFIN *	—	—	—
	Loss vs. Freq deletion	LVFDEL	—	—	—
	Reference signal source	—	FREF?	Internal (0)/ External (1)	—
	: Internal	RFI	—	—	—
	: External	RFE	—	—	—

Function	Listener Code	Talker Request			Remarks
		Code	Output Format	Header	
Center Frequency	Frequency Span	SPAN *	SPAN?	Frequency	SP
		SP *	SP?	Frequency	SP
	Span mode	—	SPMD?	0: Linear span	—
		—	SPM?	2: Log span	—
	Linear span	LINSP *	LINSP?	Frequency	SP
		LS *	LS?	Frequency	SP
	Full span	FLSP	—	—	—
		FS	—	—	—
	Log span	LOGSP	—	—	—
		LG	—	—	—
	Log start	LGSTART *	LGSTART?	Frequency	LGA
		LGSRT *	LGSRT?	Frequency	LGA
		LGA *	LGA?	Frequency	LGA
	Log stop	LGSTOP *	LGSTOP?	Frequency	LGB
		LGSTP *	LGSTP?	Frequency	LGB
		LGB *	LGB?	Frequency	LGB
	Zero span	ZROSP	—	—	—
		ZS	—	—	—
	Last span	LTSP	—	—	—
	Start Frequency	START *	START?	Frequency	FA
SRT *		SRT?	Frequency	FA	
FA *		FA?	Frequency	FA	
FT *		FT?	Frequency	FA	
Stop Frequency	STOP *	STOP?	Frequency	FB	
	STP *	STP?	Frequency	FB	
	FB *	FB?	Frequency	FB	
	FP *	FP?	Frequency	FB	

Function	Listener Code	Talker Request			Remarks	
		Code	Output Format	Header		
Reference Level	Reference Level	REF *	REF?	Level	Unit : Header	
		RE *	RE?	Level	dBm : REB	
		RL *	RL?	Level	dBmV : REM	
					dB μ V : REU	
					dB μ Vemf : REE	
					dBpW : REP	
					V : REV	
					W : REW	
	X dB/div	DIV *	DIV?	0: 10dB/	—	
		DD *	DD?	1: 5dB/ 2: 2dB/ 3: 1dB/ 4: 0.5dB/ 5: 0.2dB/ 6: 0.1dB/	—	
Linear multiplication factor	—	LIN?	0: $\times 1$	—		
	—	LL?	1: $\times 2$	—		
		LN?	2: $\times 5$			
			3: $\times 10$			
LINEAR $\times 1$	LIN1	—	—	—		
	LN1	—	—	—		
	LL1	—	—	—		

Function	Listener Code	Talker Request			Remarks	
		Code	Output Format	Header		
LINEAR × 2 LINEAR × 5 LINEAR × 10	LIN2	-	-	-		
	LN2	-	-	-		
	LL2	-	-	-		
	LIN5	-	-	-		
	LN5	-	-	-		
	LL5	-	-	-		
	LIN10	-	-	-		
	LN10	-	-	-		
	LL10	-	-	-		
Reference Level	Reference level display unit	-	UNIT?	0:dBm	-	
		-	UN?	1:dBmV	-	
			AUNITS?	2:dB μ V		
				3:dB μ Vemf		
				4:dBpW		
				6:V		
				7:W		
	dBm	UDBM	-	-	-	
		AUNITS DBM	-	-	-	
		KSA	-	-	-	
dBmV	UB	-	-	-		
	UDBMV	-	-	-		
	AUNITS DBMV	-	-	-		
	KSB	-	-	-		
	UM	-	-	-		

Function	Listener Code	Talker Request			Remarks	
		Code	Output Format	Header		
Reference Level	dB μ V	UDBUV	-	-	-	
		AUNITS DBUV	-	-	-	
		KSC	-	-	-	
		UU	-	-	-	
	dB μ Vemf	UEMF	-	-	-	
		UE	-	-	-	
	dBpW	UDBPW	-	-	-	
		UW	-	-	-	
	volts	UVLT	-	-	-	
		AUNITS V	-	-	-	
		KSD	-	-	-	
	watts	UWAT	-	-	-	
		AUNITS W	-	-	-	
	Level offset	REFOFS *	REFOFS?	ON/OFF + Level	RO	
		RO *	RO?	ON/OFF + Level	RO	
	Level offset ON	REFOFS ON*	-	-	-	
RO ON *		-	-	-		
RON *		-	-	-		
Level offset OFF	REFOFS OFF	-	-	-		
	RO OFF	-	-	-		
	ROF	-	-	-		
Low noise mode	-	LNI?	ON/OFF	-		
Low noise mode ON	LNI ON	-	-	-		
Low noise mode OFF	LNI OFF	-	-	-		

Function	Listener Code	Talker Request			Remarks
		Code	Output Format	Header	
Coupled Function	COUPLE	—	—	—	
	CO	—	—	—	
RBW	RBW *	RBW?	Frequency	RB	
	RB *	RB?	Frequency	RB	
	RBW AUTO	RBAUTO	AUTO/MANUAL	—	
	BA	BA?	AUTO/MANUAL	—	
VBW	VBW *	VBW?	Frequency	VB	
	VB *	VB?	Frequency	VB	
	VBW AUTO	VBAUTO	AUTO/MANUAL	—	
	VA	VA?	AUTO/MANUAL	—	
SWP	SWP *	SWP?	Time		
	SW *	SW?	Time		
	ST *	ST	Time		
	SWP AUTO	SWAUTO	AUTO/MANUAL		
	AS	AS?	AUTO/MANUAL		
ATT	ATT *	ATT?	Level	AT	
	AT *	AT?	Level	AT	
	ATT AUTO	ATAUTO	AUTO/MANUAL	—	
	AA	AA?	AUTO/MANUAL	—	
Couple AUTO	COAUTO	—	—		
	AC	—	—		
Couple ALL AUTO	COALL	COALL?	AUTO/MANUAL		
	AL	AL?	AUTO/MANUAL		
MIN. ATT	ATMIN *	ATMIN?	ON/OFF + Level	ATM	
MIN. ATT ON	ATMIN ON *	—	—	—	
MIN. ATT OFF	ATMIN OFF	—	—	—	

Function	Listener Code	Talker Request			Remarks	
		Code	Output Format	Header		
Coupled Function	RBW:SPAN	CORS *	CORS ?	ON/OFF + Ratio	CORS	
	RBW:SPAN ON	CORS ON *	-	-	-	
	RBW:SPAN OFF	CORS OFF	-	-	-	
	VBW:RBW	COVR *	COVR?	ON/OFF + Ratio	COVR	
	VBW:RBW ON	COVR ON *	-	-	-	
	VBW:RBW OFF	COVR OFF	-	-	-	
	Digital IF mode	-	FFT?	0: OFF 1: ON (100 Hz contained) 2: OFF (100 Hz not contained)		
	Digital IF ON	FFT ON	-	-	-	
	ON (RBW 100Hz contained)	FFT1	-	-	-	
	ON (RBW 100 Hz not contained)	FFT2	-	-	-	
	Digital IF OFF	FFT OFF	-	-	-	
	Menu	Menu	MENU	-	-	
		ME	-	-		
Menu	Trigger mode	-	TRMD?	0: FREE RUN		
		-	TM?	1: LINE 2: VIDEO 3: TV_V 4: TV_H 5: External 6: Single		

Function	Listener Code	Talker Request			Remarks
		Code	Output Format	Header	
Menu	FREE RUN	FREE	-	-	-
		TM FREE	-	-	-
		FR	-	-	-
	LINE	LINE	-	-	-
		TM LINE	-	-	-
		LI	-	-	-
	VIDEO	VIDEO	-	-	-
		VI	-	-	-
	TV__V	TVV	-	-	-
		TV	-	-	-
	TV__H ODD	TVHODD *	TVHODD?	Integer	TVH
	TV__H EVEN	TVHEVEN *	TVHEVEN?	Integer	TVH
	External	EXT	-	-	-
		TM EXT	-	-	-
		EX	-	-	-
	Trigger slope	+ TRIGSLP +	-	-	-
		- TRIGSLP -	-	-	-
	Trigger level	TR	TR?	Integer	TR
<hr/>					
Detector mode?	-	DTMD?	0: Posi-Nega	-	
	-	DM?	1: Positive	-	
		DET?	2: Negative		
			3: Sample		
Posi-Nega	DTN	-	-	-	
	DET NRM	-	-	-	
	KSa	-	-	-	
Positive	DTP	-	-	-	
	DET POS	-	-	-	
	KSb	-	-	-	

Function	Listener Code	Talker Request			Remarks	
		Code	Output Format	Header		
Negative	DTG	-	-	-		
	DET NEG	-	-	-		
	Sample	KSd	-	-	-	
		DTS	-	-	-	
		DET SMP	-	-	-	
		KSe	-	-	-	
Menu	Sweep mode	-	SWMD?	0: Normal & Full	-	
		-	SWM?	1: Normal & Window	-	
				10: Manual & Full		
				11: Manual & Window		
				20: Single & Full		
				21: Single & Window		
	Normal	CONTS	-	-	-	
		SN	-	-	-	
	Manual	MANSWP	-	-	-	
		SM	-	-	-	
	Single	SNGLS	-	-	-	
		SI	-	-	-	
	Window ON	WDOSWP ON	-	-	-	
		SDW	-	-	-	
	Window OFF	WDOSWP OFF	-	-	-	
Reset & Start	SR	-	-	-		
Take Sweep	TS	-	-	-		
Sound mode	-	SDMD?	0: OFF			
	-	SD?	1: ON (AM)			
			2: ON (FM)			

	Function	Listener Code	Talker Request			Remarks
			Code	Output Format	Header	
Menu	Sound ON (AM or FM)	SON				
	Sound ON (AM)	SD AM	-	-	-	
		SAM	-	-	-	
	Sound ON (FM)	SD FM	-	-	-	
		SFM	-	-	-	
	Sound OFF	SD OFF	-	-	-	
		SOF	-	-	-	
	Sound volume	SDVOL *	SDVOL?	Integer	VOL	
		SDV *	SDV?	Integer	VOL	
	Volume (Maximum)	VX	-	-	-	
	Volume (Intermediate)	VD	-	-	-	
	Volume (Minimum)	VN	-	-	-	
	Pause time	PAUSE *	PAUSE?	ON/OFF + Time	PU	
		PU *	PU?	ON/OFF + Time	PU	
	Marker pause ON	PAUSE ON *	-	-	-	
		PU ON *	-	-	-	
		PUN *	-	-	-	
	Marker pause OFF	PAUSE OFF	-	-	-	
		PU OFF	-	-	-	
		PUF	-	-	-	
	Squelch	SQE *	SQE?	ON/OFF + Level	SQE	
	Squelch ON	SQE ON *	-	-	-	
	Squelch OFF	SQE OFF	-	-	-	
	AGC	-	SDAGC?	ON/OFF	-	
	AGC ON	SDAGC ON	-	-	-	
	AGC OFF					

Function	Listener Code	Talker Request			Remarks	
		Code	Output Format	Header		
Menu	Display line	DL *	DL?	ON/OFF + Level	Unit : Header dBm : DLB dBmV : DLM dB μ V : DLU dB μ Vemf : DLE dBpW : DLP V : DLV W : DLW	
	Display line ON	DL ON *	-	-	-	
		DLN *	-	-	-	
	Display line OFF	DL OFF	-	-	-	
		DLF	-	-	-	
	Character display	-	CHD?	ON/OFF	-	
		-	ANNOT?	-	-	
	Character display ON	CHD ON	-	-	-	
		ANNOT ON	-	-	-	
	Character display OFF	DHC OFF	-	-	-	
		ANNOT OFF	-	-	-	
	Grid	-	GR?	ON/OFF	-	
		-	GRAT?	-	-	
Grid ON	GR ON	-	-	-		
	GRAT ON	-	-	-		
	GN	-	-	-		

Function	Listener Code	Talker Request			Remarks		
		Code	Output Format	Header			
Menu	Grid OFF	GR OFF	-	-	-		
		GRAT OFF	-	-	-		
		GF	-	-	-		
	Frequency display	-	FRD?	ON/OFF	-		
	Frequency display ON	FRD ON	-	-	-		
	Frequency display OFF	FRD OFF	-	-	-		
	Input format	-	IN?	0 : RF 1 : PI (Plug IN)	-		
	RF input	RFIN	-	-	-		
	PI input	PI*	PI?	Level	PI		
	Impedance	-	OHM?	0 : 50 Ω 1 : 75 Ω	-		
	50 Ω	OHM50	-	-	-		
	75 Ω	OHM75	-	-	-		
	Rear panel output	-	SWPOUT?	LOSWP (0)/AXIS (1)	-		
	AXIS	AXIS	-	-	-		
	2 V/GHz	LOSWP	-	-	-		
	Trace	Trace A	TA	TA?	(Lower bytes) 0: write 1: view 2: blank 3: normalize 4: A-DL→A 5: A-B→A 6: B-A→A	-	

Function	Listener Code	Talker Request			Remarks
		Code	Output Format	Header	
			(Upper bytes) 0: nothing 1: + max hold 2: + averaging 3: + min hold		
A write	AWRITE	-	-	-	
	AW	-	-	-	
A view	AVIEW	-	-	-	
	AV	-	-	-	
A blank	ABLANK	-	-	-	
	AB	-	-	-	
A max hold	AMAX	-	-	-	
	AM	-	-	-	
A min hold	AMIN	-	-	-	
A averaging	AAVG *	AAVG?	Integer	AG	
	AG *	AG?	Integer	AG	
start	AGR	-	-	-	
stop	AGS	-	-	-	
pause	AGP	-	-	-	
continue	AGC	-	-	-	
1 time	AG1	-	-	-	
continue	AG0	-	-	-	
Normalize A					
Normalize A ON	ANORM	-	-	-	
	AN	-	-	-	
	ANORM ON	-	-	-	
	AN ON	-	-	-	
	ANN	-	-	-	

Trace

Function	Listener Code	Talker Request			Remarks	
		Code	Output Format	Header		
Normalize A OFF	ANORM OFF	-	-	-		
	AN OFF	-	-	-		
	ANF	-	-	-		
	Correction data save	AR	-	-		
	Instant normalize A	AI	-	-		-
		SHTA	-	-		-
A XCH B	ACHB	-	-	-		
	CH	-	-	-		
A - B → A	ABA	-	-	-		
	TRO	-	-	-		
B - A → A	BAA	-	-	-		
	TR1	-	-	-		
A - DL → A	ADLA	-	-	-		
	TR2	-	-	-		
Trace A clear	CWA	-	-			
Trace B	TB	TB?	(Lower bytes)			
			0: write			
			1: view			
			2: blank			
			3: normalize			
			4: B - DL → B			
(Upper bytes)						
0: nothing						
1: + max hold						
2: + averaging						
3: + min hold						

Function	Listener Code	Talker Request			Remarks
		Code	Output Format	Header	
B write	BWRITE	—	—	—	
	BW	—	—	—	
B view	BVIEW	—	—	—	
	BV	—	—	—	
B blank	BBLANK	—	—	—	
	BB	—	—	—	
B max hold	BMAX	—	—	—	
	BM	—	—	—	
B min hold	BMIN	—	—	—	
B averaging	BAVG *	BAVG?	Integer	BG	
	BG *	BG?	Integer	BG	
start	BGR	—	—	—	
stop	BGS	—	—	—	
pause	BGP	—	—	—	
continue	BGC	—	—	—	
1 time	BG1	—	—	—	
continue	BG0	—	—	—	
Normalize B					
Normalize B ON	BNORM	—	—	—	
	BN	—	—	—	
	BNORM ON	—	—	—	
	BN ON	—	—	—	
	BNN	—	—	—	
Normalize B OFF	BNORM OFF	—	—	—	
	BN OFF	—	—	—	
	BNF	—	—	—	

Trace

Function	Listener Code	Talker Request			Remarks	
		Code	Output Format	Header		
Trace	Correction data save	BR	-	-	-	
	Instant normalize B	BI	-	-	-	
		SHTB	-	-	-	
	B - DL → B	BDLB	-	-	-	
	Trace B clear	TR3	-	-	-	
	CWB	-	-	-		
GPIB	Local	LOCAL	-	-	-	
		LC	-	-	-	
	GPIB address	-	AD?	Integer	AD	
		-	SHLC?	Integer	AD	
User definition	User Definition	USER	-	-	-	
		UR	-	-	-	
	1	UR1	-	-	-	
	2	UR2	-	-	-	
	3	UR3	-	-	-	
	4	UR4	-	-	-	
	5	UR5	-	-	-	
	6	UR6	-	-	-	
7	UR7	-	-	-		
Recall	Recall	RECALL *	RECALL?	0: Normal recall	-	
		RC *	RC?	1: Fast recall	-	
	Normal recall	RCNORM *	-	-	-	
		RN *	-	-	-	
	Fast recall	RCFAST *	-	-	-	Only one digit
		RF	-	-	-	

Function		Listener Code	Talker Request			Remarks
			Code	Output Format	Header	
Save	Save	SAVE *	—	—	—	
		SV *	—	—	—	
		SHRC *	—	—	—	
Preset	Instrument Preset	IP	—	—	—	
Marker	Marker ON	MKR ON *	MKR?	0: Marker OFF	—	
		MN *	MN?	1: Normal marker	—	
		MKN *	—	2: Δ marker	—	
	Marker frequency	—	MF?	Frequency	MF	
	Marker level	—	ML?	Level	Unit : Header dB : MLD dBm : MLB dBmV : MLM dB μ V : MLU dB μ Vemf : MLE dBpW : MLP V : MLV W : MLW dBm/Hz : MLH dB μ V/Hz : MLL dBc/Hz : MLC	

Function	Listener Code	Talker Request			Remarks
		Code	Output Format	Header	
Frequency + Level	—	MFL?	Frequency + Level	Same as MF, ML	
Normal marker	MKNORM *	MKNORM?	Frequency	MF	
	MKN *	—	—	—	
	MK *	MK?	Frequency	MF	
Δ marker	MKDLT *	MKDLT?	Frequency	MF	
	MKD *	—	—	—	
	MT *	MT?	Frequency	MF	
Fixed marker	—	FIX?	ON/OFF	—	
		FX?	ON/OFF	—	
Fixed marker ON	FIX ON	—	—	—	
	FX ON	—	—	—	
	FXN	—	—	—	
Fixed marker OFF	FIX OFF	—	—	—	
	FX OFF	—	—	—	
	FXF	—	—	—	
1/ Δ marker		REDLT?	ON/OFF + calculated value (See Note below)	MF	
1/ Δ marker ON	REDLT ON	—	—	—	
1/ Δ marker OFF	REDLT OFF	—	—	—	
Counter	—	COUNT?	ON/OFF	—	
	—	CT?	ON/OFF	—	
	—	CN?	ON/OFF	—	
Counter ON	COUNT ON	—	—	—	
	CT ON	—	—	—	
	CN ON	—	—	—	

Note: Calculated value is used as time or frequency data.

Function	Listener Code	Talker Request			Remarks
		Code	Output Format	Header	
Marker	Resolution : 1kHz	CN0	-	-	-
	: 100 Hz	CN1	-	-	-
	: 10 Hz	CN2	-	-	-
	: 1 Hz	CN3	-	-	-
	Counter OFF	COUNT OFF	-	-	-
		CT OFF	-	-	-
		CN OFF	-	-	-
		CNF	-	-	-
	Counter operation mode	-	CTMD?	FREQ counter: 0	
				MKR counter: 1	
	MKR counter	CTMK	-	-	-
	FREQ counter	CTFR	-	-	-
	Signal track	--	SIG?	ON/OFF	-
		-	SG?	ON/OFF	
Signal track ON	SIG ON	-	-	-	
	SG ON	-	-	-	
	SGN	-	-	-	
Signal track OFF	SIG OFF	-	-	-	
	SG OFF	-	-	-	
	SGF	-	-	-	
Noise/Hz	NOISE *	NOISE?	0: OFF + Frequency	NI	
	NI *	NI?	1: dBm + Frequency	NI	
			2: dB μ v + Frequency	NI	
			3: dBc + Frequency	NI	
dBm/Hz ON	NIDBM	-	-	-	
	NIM	-	-	-	

	Function	Listener Code	Talker Request			Remarks
			Code	Output Format	Header	
Marker	dB μ V/ \sqrt Hz ON	NIDBU	—	—	—	
		NIU	—	—	—	
	dBc/Hz ON	NIDBC	—	—	—	
	Noise/Hz OFF	NIC	—	—	—	
		NOISE OFF	—	—	—	
		NI OFF	—	—	—	
		NIF	—	—	—	
	Fixed Mkr Peak	FXP	—	—	—	
	dB down					
	X dB down width	MKBW *	MKBW?	Level	XDB	
	X dB down	DBDOWN	—	—	—	
		XDB	—	—	—	
	X dB down left	DBLEFT	—	—	—	
		XDL	—	—	—	
	X dB down right	DBRIGHT	—	—	—	
		XDR	—	—	—	
	X dB relative	DBREL	—	—	—	
		DCO	—	—	—	
	X dB abs. left	DBABSL	—	—	—	
		DC1	—	—	—	
	X dB abs. right	DBABSR	—	—	—	
		DC2	—	—	—	
X dB execution state	—	DC?	0: Relative 1: Absolute (Left) 2: Absolute (Right)			

	Function	Listener Code	Talker Request			Remarks
			Code	Output Format	Header	
Marker	Continuous dB down	—	CDB?	ON/OFF	—	
	Continuous dB down ON	CDB ON	—	—	—	
	Continuous dB down OFF	CDB OFF	—	—	—	
	AUTO TUNE	TUNE *	TUNE?	Frequency	TN	
		TN *	TN?	Frequency	TN	
	Pre-selection					
	Auto peaking	PPA	—	—	—	
	Manual peaking	PPM *	PPM?	Integer	—	
	Marker display					
	Relative	MDR	—	—	—	
	Absolute	MDA	—	—	—	
	Marker position					
	Upper right	MDU	—	—	—	
	Lower right	MDL	—	—	—	
Marker OFF	MKR OFF	—	—	—		
	MKOFF	—	—	—		
	MO	—	—	—		
	MF	—	—	—		
Multi Marker	Multi Marker ON	MLT	MLT?	ON/OFF	—	
	Multi Marker OFF	MF or MO	—	—	—	
	Active marker shift	MN* or MK*	—	—	—	
	Multi Marker No.1 ON	MLN1 *	—	—	—	
	Multi Marker No.1 OFF	MLF1	—	—	—	

	Function	Listener Code	Talker Request			Remarks
			Code	Output Format	Header	
Multi Marker	Multi Marker No.2 ON	MLN2 *	-	-	-	
	Multi Marker No.2 OFF	MLF2	-	-	-	
	Multi Marker No.3 ON	MLN3 *	-	-	-	
	Multi Marker No.3 OFF	MLF3	-	-	-	
	Multi Marker No.4 ON	MLN4 *	-	-	-	
	Multi Marker No.4 OFF	MLF4	-	-	-	
	Multi Marker No.5 ON	MLN5 *	-	-	-	
	Multi Marker No.5 OFF	MLF5	-	-	-	
	Multi Marker No.6 ON	MLN6 *	-	-	-	
	Multi Marker No.6 OFF	MLF6	-	-	-	
	Multi Marker No.7 ON	MLN7 *	-	-	-	
	Multi Marker No.7 OFF	MLF7	-	-	-	
	Multi Marker No.8 ON	MLN8 *	-	-	-	
	Multi Marker No.8 OFF	MLF8	-	-	-	

Function		Listener Code	Talker Request			Remarks
			Code	Output Format	Header	
Multi Marker	Active marker frequency	-	MF?	Frequency	MF	
	Active marker level	-	ML?	Level	Unit : Header dB : MLD dBm : MLB dBmV : MLM dB _μ V : MLU dB _μ V _{emf} : MLE dBpW : MLP V : MLV W : MLW dBm/Hz : MLH dB _μ V/Hz : MLL dBc/Hz : MLC	
	Frequency + Level	-	MFL?	Frequency + Level	Same as MF, ML	
	Multi Marker frequency	-	MLSF?	Frequency	Same as MF	8 items + ΔMKR
	Multi Marker all level	-	MLSL?	Level	Same as ML	8 items + ΔMKR

Function	Listener Code	Talker Request			Remarks	
		Code	Output Format	Header		
Peak Search	Peak Search	PWAK	-	-	-	
		MKPK	-	-	-	
		MKPK HI	-	-	-	
		PS	-	-	-	
	NEXT peak	NXPEAK	-	-	-	
		NKPK NH	-	-	-	
		NXP	-	-	-	
	Next peak left	NXLEFT	-	-	-	
		MKPK NL	-	-	-	
		NXL	-	-	-	
	Next peak right	NXRIGHT	-	-	-	
		MKPK NR	-	-	-	
		NXR	-	-	-	
	NEXT peak MAX/MIN	NXMAXMIN	-	-	-	
		NMM	-	-	-	
	MIN search	MIN	-	-	-	
		MIS	-	-	-	
	NEXT MIN	NXMIN	-	-	-	
		NXM	-	-	-	
	Continuous peak	-	CP?	ON/OFF	-	
	Continuous peak ON	CP ON	-	-	-	
		CPN	-	-	-	

Function	Listener Code	Talker Request			Remarks	
		Code	Output Format	Header		
Peak Search	Continuous peak OFF	CP OFF	-	-	-	
		CPF	-	-	-	
	ΔX	DX *	DX?	Integer (1 to 700)	DX	
	ΔY	DY *	DY?	Integer (1 to 400)	DY	
	Peak range					
	Normal	PSN	-	-	-	
	Upper	PSU	-	-	-	
	Lower	PSL	-	-	-	
	Peak list	-	PLS?	ON/OFF	-	
	Peak list ON	PLS ON	-	-	-	
Peak list OFF	PLS OFF	-	-	-		
Alternated Modulating Distortion Measurement	PKTHIRD	-	-	-		
MKR \uparrow	MKR \rightarrow	MG	-	-	-	
	MKR \rightarrow CF	MKCF	-	-	-	
		MC	-	-	-	
	MKR \rightarrow REF	MKRL	-	-	-	
		MR	-	-	-	
	Δ MKR \rightarrow SPAN	MTSP	-	-	-	
		DS	-	-	-	
	MKR \rightarrow CF step	MKCS	-	-	-	
		MO	-	-	-	
	Δ MKR \rightarrow CF step	MTCS	-	-	-	
	M1	-	-	-		

Function	Listener Code	Talker Request			Remarks	
		Code	Output Format	Header		
MKR ↑	ΔMKR → CF	MTCF	—	—	—	
	MKR → MKR step	MKMKS	—	—	—	
		M2	—	—	—	
	ΔMKR → MKR step	MTMKS	—	—	—	
		M3	—	—	—	
	MKR step size	MKS *	MKS?	Frequency	MKS	
		MPM *	MPM?	Frequency	MKS	
MKR step AUTO	MKSAUTO	MKSAUTO?	AUTO/MANUAL	—		
	MPA	MPA?	AUTO/MANUAL	—		
Measurement Window	Measurement Window	WD0	WD0?	ON/OFF	—	
		SH0	SH0?	ON/OFF	—	
		—	WN?	ON/OFF	—	
	Window ON	WDO ON	—	—	—	
		WN	—	—	—	
	Window OFF	WDO OFF	—	—	—	
		WF	—	—	—	
	Center position : X	WDOLX*	WDOLX?	Integer (0 to 700)	WLX	
		WLX*	WLX?	Integer (0 to 700)	WLX	
		Center position : Y	—	WDOLY?	Integer (0 to 400)	WLY
			—	WLY?	Integer (0 to 400)	WLY
	Window width	WDODX*	WDODX?	Integer (0 to 700)	WDX	
		WDX*	WDX?	Integer (0 to 700)	WDX	
Window height	—	WDODY?	Integer (0 to 400)	WDY		
	—	WDY?	Integer (0 to 400)	WDY		

Function	Listener Code	Talker Request			Remarks	
		Code	Output Format	Header		
Measurement Window	Start frequency	WDOSRT *	WDOSRT?	Frequency	WTF	
		WTF *	WTF?	Frequency	WTF	
	Stop frequency	WDOSTP *	WDOSTP?	Frequency	WPF	
		WPF *	WPF?	Frequency	WPF	
	Upper limit level	WDOUP *	WDOUP?	Level	WUL	
		WUL *	WUL?	Level	WUL	
	Lower limit level	WDOLOW *	WDOLOW?	Level	WLL	
		WLL *	WLL?	Level	WLL	
	GO/NO GO decision	—	CM?	NG: 0 OK: 1	—	
	GO/NO GO decision A execution	CMA	—	—	—	
GO/NO GO decision B execution	CMB	—	—	—		
EMC	EMC	EMC	—	—	—	
		SH1	—	—	—	
	Antenna type	—	ANT?	0: OFF 1: Dipole 2: Log peri 3: TR17203	—	
	Antenna select					
	Dipole	ANT0	—	—	—	
		AN0	—	—	—	
	Log peri	ANT1	—	—	—	
	AN1	—	—	—		
TR17203	ANT2	—	—	—		
	AN2	—	—	—		

Function	Listener Code	Talker Request			Remarks	
		Code	Output Format	Header		
EMC	Antenna OFF	ANT OFF	-	-	-	
		AF	-	-	-	
	Antenna correction table	-	ANCORR?	ON/OFF	-	
		-	CR?	ON/OFF	-	
	Antenna correction table ON	ANCORR ON	-	-	-	
		CR ON	-	-	-	
		CRN	-	-	-	
	Antenna correction table OFF	ANCORR OFF	-	-	-	
		CR OFF	-	-	-	
		CRF	-	-	-	
	Antenna correction table entry	CRIN *	-	-	-	
	Antenna correction table delete	CRDEL	-	-	-	
	Level correction	-	LVCORR?	ON/OFF	-	
	Level correction ON	LVCORR ON	-	-	-	
	Level correction OFF	LVCORR OFF	-	-	-	
	EMC Trace detection	-	EMCDET?	0: NORMAL 1: QP 2: MEAN 3: PEAK		
		: QP	EMCDET QP			
		: MEAN	EMCDET MEAN			
		: PEAK	EMCDET PEAK			
		: NORMAL	EMCDET NRM			

Function	Listener Code	Talker Request			Remarks
		Code	Output Format	Header	
QP	—	QP?	ON/OFF	—	
QP ON	QP ON	—	—	—	
	QN	—	—	—	
QP OFF	QP OFF	—	—	—	
	QF	—	—	—	
QP BW AUTO	QPAUTO	QPAUTO?	0: AUTO	—	
	QA	QA?	1: 200 Hz	—	
		—	2: 9 kHz	—	
		—	3: 120 kHz	—	
		—	4: 1 MHz	—	
QP BW					
200 Hz	QP0	—	—	—	
9 kHz	QP1	—	—	—	
120 kHz	QP2	—	—	—	
1 MHz	QP3	—	—	—	At PEAK only
Select the limit line type	—	LIMTYP?	0 : FREQ 1 : TIME	— —	
Limit line type selection					
Frequency domain	LIMTYP FREQ	—	—	—	
Time domain	LIMTYP TIME	—	—	—	
Limit line frequency or time					
ABS/REL?	—	LIMPOS?	0 : ABS 1 : REL	— —	
ABS	LIMPOS ABS	—	—	—	
REL	LIMPOS REL	—	—	—	

EMC

Function	Listener Code	Talker Request			Remarks
		Code	Output Format	Header	
Limit line level					
ABS/REL?	-	LIMAPOS?	0 : ABS 1 : REL	-	
ABS	LIMAPOS ABS	-	-	-	
REL	LIMAPOS REL	-	-	-	
Limit line frequency or time shift	LIMSFT	LIMSFT?	frequency or time	SFT	
Limit line level shift	LIMASFT	LIMASFT?	level	SFTA	
Limit line 1	-	LMTA?	ON/OFF	-	
Limit line 1 ON	LMTA ON	-	-	-	
	LAN	-	-	-	
Limit line 1 OFF	LMTA OFF	-	-	-	
	LAF	-	-	-	
Limit line 1 table entry	LMTAIN *	-	-	-	
Limit line 1 table delete	LMTADEL	-	-	-	
Limit line 2	-	LMTB?	ON/OFF	-	
Limit line 2 ON	LMTB ON	-	-	-	
	LBN	-	-	-	
Limit line 2 OFF	LMTB OFF	-	-	-	
	LBF	-	-	-	
Limit line 2 table entry	LMTBIN *	-	-	-	
Limit line 2 table delete	LMTBDEL	-	-	-	
Limit line type selection	-	LIMTYP?	0: Frequency domain 1: Time domain	-	
: Frequency domain	LIMTYP FREQ	-	-	-	
: Time domain	LIMTYP TIME	-	-	-	

Function	Listener Code	Talker Request			Remarks	
		Code	Output Format	Header		
EMC	Limit line horizontal position	—	LIMPOS?	0: Absolute position 1: Relative position	—	
	: Absolute toward X axis	LIMPOS ABS	—	—	—	
	: Relative toward X axis	LIMPOS REL	—	—	—	
	Limit line vertical position	—	LIMAPOS	0: Absolute position 1: Relative position	—	
	: Absolute toward X axis	LIMAPOS ABS	—	—	—	
	: Relative toward X axis	LIMAPOS REL	—	—	—	
	Limit horizontal shift	LIMSFT *	LIMSFT?	Frequency or time	SFT	
	Limit vertical shift	LIMASFT *	LIMASFT?	Level	SFTA	
Calibration	Calibration	CAL	—	—	—	
		SH7	—	—	—	
	CAL ALL	CLALL	—	—	—	
		CLA	—	—	—	
	Total gain calibration	CLTOTAL	—	—	—	
		CLG	—	—	—	
	Input ATT calibration	CLATT	—	—	—	
		IT0	—	—	—	
	IF step AMP calibration	CLSTEP	—	—	—	
		IT1	—	—	—	
	RBW switch calibration	CLRBW	—	—	—	
		IT2	—	—	—	
	Log linearity calibration	CLLOG	—	—	—	
		IT3	—	—	—	
	AMPTD MAG calibration	CLMAG	—	—	—	
		IT4	—	—	—	

Function	Listener Code	Talker Request			Remarks	
		Code	Output Format	Header		
Calibration	PBW calibration	CLPBW	-	-	-	
		IT6	-	-	-	
	Calibration level	CL *	CL?	Level	Unit : Header dBm : CLB dBmV : CLM dB μ V : CLU dB μ Vemf : CLE dBpW : CLP V : CLV W : CLW	
		CLN *	-	-	-	
	Calibration REF	CLREF *	-	-	-	Knob alone
	f characteristics correction?	-	FRCORR?	ON/OFF	-	
		-	FC?	ON/OFF	-	
	f characteristics correction ON	FRCORR ON	-	-	-	
		FC ON	-	-	-	
		FCN	-	-	-	
	f characteristics correction OFF	FRCORR OFF	-	-	-	
		FC OFF	-	-	-	
		FCF	-	-	-	
	CAL correction?	-	CLCORR?	ON/OFF	-	
	-	CC?	ON/OFF	-		

Function	Listener Code	Talker Request			Remarks	
		Code	Output Format	Header		
Calibration	CAL correction ON	CLCORR ON	-	-	-	
		CC ON	-	-	-	
		CCN	-	-	-	
	CAL correction OFF	CLCORR OFF	-	-	-	
		CC OFF	-	-	-	
		CCF	-	-	-	
Plotter	Plotter	SH8	-	-	-	
	Type					
	R9833	PLTYPEA	-	-	-	
	HP7470	PLTYPEB	-	-	-	
	HP7475	PLTYPEC	-	-	-	
	HP7440	PLTYPED	-	-	-	
	HP7550	PLTYPEE	-	-	-	
	Data					
	All information	PLALL	-	-	-	
	Waveform alone	PLTRACE	-	-	-	
	Characters alone	PLCHAR	-	-	-	
	Grid alone	PLGRAT	-	-	-	
	Marker, DL, WDO	PLMKR	-	-	-	
	Multi Marker List	PLMULTI	-	-	-	
	Antenna table	PLANT	-	-	-	
Limit 1 table	PLLMTA	-	-	-		
Limit 2 table	PLLMTB	-	-	-		
Loss table	PLLOSS	-	-	-		
Paper						
A4	PLA4	-	-	-		
A3	PLA3	-	-	-		

Function	Listener Code	Talker Request			Remarks
		Code	Output Format	Header	
Plotter	Division size				
	Single	PLPIC1	-	-	-
	Division into 2	PLPIC2	-	-	-
	Division into 4	PLPIC4	-	-	-
	Print position				
	Center	PLMID	-	-	-
	Left	PLLEFT	-	-	-
	Right	PLRIGHT	-	-	-
	Upper left	PLUPLLEFT	-	-	-
	Upper right	PLUPRIGHT	-	-	-
	Lower left	PLLOWLEFT	-	-	-
	Lower right	PLLOWRIGHT	-	-	-
	Number of pens				
	1 pen	PLPEN1	-	-	-
	2 pens	PLPEN2	-	-	-
	4 pens	PLPEN4	-	-	-
	6 pens	PLPEN6	-	-	-
	8 pens	PLPEN8	-	-	-
	Print position shift				
	AUTO	PLAUTO	-	-	-
Manual	PLMAN	-	-	-	
Execution					
	PLOT	-	-	-	
	PLT	-	-	-	

Function	Listener Code	Talker Request			Remarks	
		Code	Output Format	Header		
Utility	Utility	SH3	-	-	-	
	OBW	OBW *	OBW?	Percentage + Calculated value	OBW, MF	(See Note below)
	ADJ	ADJ	ADH?	Calculated value	Same as ML	(See Note below)
	ADK GRAPH	ADG	-	-	-	
	ADJ GRAPH OFF	ADG OFF	-	-	-	
	ADJ Ch space	ADCH *	ADCH?	Frequency	ADC	
	ADJ specified BW	ADBS *	ADBS?	Frequency	ADB	
	ADJ2	ADJ2	ADJ2	Calculated value	Same as ML	(See Note below)
Memory Card	Memory card	CARD	-	-	-	
		SH4	-	-	-	
	Card initialization	MCINIT	-	-	-	
		MMI	-	-	-	
	Soft menu read-in	MCLOAD	-	-	-	
		MML	-	-	-	
Soft menu write-in	MCSTORE	-	-	-		
	MMS	-	-	-		
Label	Label	-	LB?	Character string	-	Up to 30 characters
		-	SH9?	Character string	-	
	Label ON	LB ON/**/	-	-	-	Enclose the characters with /
		LON/**/	-	-	-	
	Label delete	LB OFF	-	-	-	
	LOF	-	-	-		

Note: The two calculation results are output continuously.

IF OBW: Frequency + Frequency

If ADJ: Level + Level

Function	Listener Code	Talker Request			Remarks
		Code	Output Format	Header	
Softkey		-	-	-	
Softkey No. 1	SF1	-	-	-	
Softkey No. 2	SF2	-	-	-	
Softkey No. 3	SF3	-	-	-	
Softkey No. 4	SF4	-	-	-	
Softkey No. 5	SF5	-	-	-	
Softkey No. 6	SF6	-	-	-	
Softkey No. 7	SF7	-	-	-	
Data entry					
0 to 9	0 to 9	-	-	-	
. (decimal point)	.	-	-	-	
BK SP	BS	-	-	-	
↑ (step up)	UP	-	-	-	
↓ (step down)	DN	-	-	-	
Knob up (coarse)	CU	-	-	-	
(fine)	FU	-	-	-	
Knob down (coarse)	CD	-	-	-	
(fine)	FD	-	-	-	
GHz	GZ	-	-	-	
MHz	MZ	-	-	-	
kHz	KZ	-	-	-	
Hz	HZ	-	-	-	
mV	MV	-	-	-	
mW	MW	-	-	-	
dB	DB	-	-	-	
mA	MA	-	-	-	

Function		Listener Code	Talker Request			Remarks
			Code	Output Format	Header	
Softkey	sec	SC	—	—	—	
	msec	MS	—	—	—	
	μ sec	US	—	—	—	
	ENTER	ENT	—	—	—	
Trace Data Input/output			TP?	0: 0 to 400 mode 1: 448 to 3648 mode		
Trace data	Accuracy					
	401 points	TPC	—	—	—	
	3201 points	TPF	—	—	—	
	Memory A output (ASCII)	—	TAA?	4 bytes + delimiter	—	1-point data
	(Binary)	—	TBA?	2 bytes x 700 points	—	EOI signal
	Memory B output (ASCII)	—	TAB?	4 bytes + delimiter	—	1-point data
	(Binary)	—	TBB?	2 bytes x 700 points	—	EOI signal
	Memory A input (ASCII)	TAA	—	—	—	1-point data
	(Binary)	TBA	—	—	—	EOI signal
	Memory B input (ASCII)	TAB	—	—	—	1-point data
(Binary)	TBB	—	—	—	EOI signal	

Function	Listener Code	Talker Request			Remarks
		Code	Output Format	Header	
Power Measurement	Power Measurement				
	Average times	PWTM*	PWTM?	Integer (1 to 1000)	—
	Average power ON	PWAVG ON	—	—	—
	Average power OFF	PWAVG OFF	—	—	—
	Average power value?	—	PWAVG?	Level	Unit : Header
	Total power ON	PWTOTAL ON	—	—	dBm : PWB
	Total power OFF	PWTOTAL OFF	—	—	dBmV : PWM
Total power value?	—	PWTOTAL?	Level	dBuV : PWU dBuVemf : PWE dBpW : PWP V : PWV W : PWW	
Tracking Generator	Tracking generator				R3365A/ 3371A only
	TG : ON	TG	TG?	OFF/ON	—
	: OFF	TGF			—
TG output level	TGL	TGL?	Level	Unit : Header dBm : TGB dBmV : TGM dBuV : TGU dBuVemf : TGE dBpW : TGP V : TGV W : TGW	

Function	Listener Code	Talker Request			Remarks
		Code	Output Format	Header	
Tracking generator	Power sweep : ON	PSWP ON	PSWP?	OFF/ON	—
	: OFF	PSWP OFF			—
	Start level	FA *	FA?	Level	FAB
	Stop level	FB *	FB?	Level	FBB
	Sweep time	SW *	SW?	Time	SW
	Smoothing : ON	SMTH ON *	SMTH?	OFF/ON, count	SMTH
	: OFF	SMTH OFF			
	: Count	SMTH *	SMTH?	OFF/ON, count	SMTH
	Reference line : ON	RLIN ON	RLIN?	OFF/ON	—
	: OFF	RLIN OFF			—
	Reference line offset	RLOFS *	RLOFS?	Level	RLOFS
	Reference line slope	XYR *	XYR?	Ratio	XYR
	PxdB marker : Execute	PSDB	—	—	—
	: Normal	PXDB NRM	PXDB?	Normal/Continue, level 0: Normal mode 1: Continue mode	PXDB
	: Continue	PXDB CONT	PXDB?	Normal/Continue, level	PXDB
: Level	PXDB *	PXDB?	Normal/Continue, level	PXDB	

	Function	Listener Code	Talker Request			Remarks	
			Code	Output Format	Header		
Tracking generator	Through correct : ON	FNRM ON	FNRM?	OFF/ON	-		
		: OFF					FNRM OFF
	Level calibration	LCAL	LCAL?	OFF/ON	-		
		: ON					LCAL ON
		: OFF					LCAL OFF
	Power lineality cal	PCAL	PCAL?	OFF/ON	-		
		: ON					PCAL ON
		: OFF					PCAL OFF
	f calibration	FCAL	FCAL?	AUTO/MANUAL	-		
		: Auto					FCAL AUTO
							TGA
		: Manual					FCAL MNL
							TGM

Function	Listener Code	Talker Request			Remarks
		Code	Output Format	Header	
Misc					
Header OFF	HD0	—	—	—	
Header ON	HD1	—	—	—	☆
Delimiter					
CR LF (EOI)	DL0	—	—	—	
LF	DL1	—	—	—	
(EOI)	DL2	—	—	—	
CR LF	DL3	—	—	—	☆
LF (EOI)	DL4	—	—	—	
Service request					
Interrupt ON	S0	—	—	—	
Interrupt OFF	S1	—	—	—	☆
Status clear	S2	—	—	—	
Service request mask	—	RQS?	Decimal notation equal to SRQ bit	—	
Soft menu display	—	MND?	ON/OFF	—	
Soft menu display ON	MND ON	—	—	—	
Soft menu display OFF	MND OFF	—	—	—	
Device type	—	VER?	0:R3265 1:R3271	—	
Device type (character string)	—	TYPE?	Character string + Delimiter	—	
	—	TYP?	Character string + Delimiter	—	
Revision output	—	REV?	Character string + Delimiter	—	
Screen data output	—	GPL?	64 characters x 24 lines	—	

	Function	Listener Code	Talker Request			Remarks
			Code	Output Format	Header	
Gated Sweep	Gated sweep					
	EXT trigger signal source					
	: EXT	EXT GT	-	-	-	
	: GATE IN	GTEXT	-	-	-	
	INT trigger signal source	GTINT				
	: VIDEO	VIDEO GT	-	-	-	
	: TV-V	TVV GT	-	-	-	
	: IF DET THRU LPF	IFDET THRU IFDET LPF	-	-	-	
	: IF monitor ON OFF	IFMONI ON IFMONI OFF	-	-	-	
	Trigger					
	Slope					
	: +	TRIGSLP GT +	-	-	-	
	: -	TRIGSLP GT -	-	-	-	
	Gate position	GTPOS*				
	Gate width	GTWID*				
Gated sweep						
: ON	GTSWP ON	-	-	-		
: OFF	GTSWP OFF	-	-	-		
Gated mode off	GTOFF	-	-	-		
Delay Sweep	Delay sweep					
	Trigger signal					
	Source					
	: video	VIDEO DLY	-	-	-	
	: tv-v	TVV DLY	-	-	-	
	: ext	EXT DLY	-	-	-	
Trigger slope						
: +	TRIGSLP DLY +	-	-	-		
: -	TRIGSLP DLY -	-	-	-		

Function	Listener Code	Talker Request			Remarks	
		Code	Output Format	Header		
Delay Sweep	Delay time	DLYTIM*				
	Delay sweep Time	DLYSWTIM*				
	Delay sweep : ON	DLYSWP ON	—	—	—	
	Delay sweep : OFF	DLYSWP OFF	—	—	—	
	Delay step size : Auto	DLYSTEP AUTO	—	—	—	
	Delay step size : Manual	DLYSTEP MAN*	—	—	—	
	Delay mode off	DLYOFF	—	—	—	
	Simulated Analog Display	Simulated Analog Display				
		Simulated analog display ON	ANLG ON	—	—	—
Simulated analog display OFF		ANLG OFF	—	—	—	
Display density		ANLG* (See Note below)	—	—	—	
ON/OFF + Display density		—	ANLG?	OFF/ON + Integer (1 to 30)	—	
CONT		ANLG CONT	—	—	—	
PAUSE		ANLG PAUSE	—	—	—	
Marker frequency		MKX*	MKX?	Frequency	—	
Marker level		MKY* (See Note below)	MKY?	Level	—	
Maker ON		MKX ON	—	—	—	
Maker OFF	MKX OFF	—	—	—		

Note : Specify the data of 1 to 30.

Function	Listener Code	Talker Request			Remarks
		Code	Output Format	Header	
Simulated Analog Display	X Cursor	CSRX*	CSRX?	Frequency	—
	ΔX Cursor	CSRDX*	CSRDX?	Frequency	—
	X Cursor ON	CSRX ON	—	—	—
	ΔX Cursor ON	CSRDX ON	—	—	—
	X Cursor OFF	CSRX OFF	—	—	—
	Y Cursor	CSRY*	CSRY?	Level	—
	ΔY Cursor	CSRDY*	CSRDY?	Level	—
	Y Cursor ON	CSRY ON	—	—	—
	ΔY Cursor ON	CSRDY ON	—	—	—
	Y Cursor OFF	CSRY OFF	—	—	—
	Read out total waveform data	—	OPANLG?	—	—
PASS/FAIL Decision	PASS/FAIL Decision				
	Consecutive mode?	—	PFC?	OFF/ON	—
	Consecutive mode ON	PFC ON	—	—	—
	Consecutive mode OFF	PFC OFF	—	—	—
	Judgment result?		PFJ?	0 : FAIL 1 : PASS	—
	Trace A judgment	PFJ A			
	Trace B judgment	PFJ B			
Judgment result (details)	—	OPF?	0 : PASS 1 : UPPER 2 : LOWER 3 : UPPER&LOWER 4 : ERROR		
Upper FAIL point binary output	—	FPU?	FAIL point counter (2byte) + FAIL point (2byte) *FAIL point counter	—	EOI Signal
Lower FAIL point binary output	—	FPL?	FAIL point counter (2byte) + FAIL point (2byte) *FAIL point counter	—	EOI Signal

Function	Listener Code	Talker Request			Remarks
		Code	Output Format	Header	
Root Nyquist Filter	Root Nyquist Filter				
	√ Nyquist F, ON	NQST ON	—	—	
	√ Nyquist F, OFF	NQST OFF	—	—	
		—	NQST?	OFF/ON	—
	JDC mode	NQST JDC	—	—	—
	NADC mode	NQST NADC	—	—	—
	Symbol rate Role factor	BRATE* RFCT*	BRATE? RFCT?	Frequency 0.01 to 0.99	— —
Split-Screen	Split-Screen				
	A/B mode	MLTSCR AB	—	—	—
	ZOOM mode	MLTSCR ZOOM	—	—	—
	Normal screen	MLTSCR OFF	—	—	—
	Split-Screen mode?	—	MLTSCR?	0: Normal screen 1: A/B 2: ZOOM	
	Zoom window position	ZOOM POS *	ZOOM POS ?	Frequency	—
	Zoom window width	ZOOM WID *	ZOOM WID ?	Frequency	—
	Peak window	ZOOM HI	—	—	—
	NEXT window	ZOOM NH	—	—	—
	NEXT RIGHT window	ZOOM NR	—	—	—
	NEXT LEFT window	ZOOM NL	—	—	—
	Trace A active	TA	—	—	—
Trace B active	TB	—	—	—	

Table 6-6 Examples of Data Entry (GPIB codes with asterisk)

Command example	Description
CF100MZ	Sets center frequency to 100 MHz.
CS100KZ	Sets frequency step size to 100 kHz.
FON10MZ	Turns frequency offset ON and set it to 10 MHz.
SP500MZ or LS500MZ	Sets frequency span to 500 MHz.
LGA100MZ	Sets log start frequency to 100 MHz.
LGB1000MZ	Sets log stop frequency to 1 GHz.
FA100KZ or FT100KZ	Sets start frequency to 100 kHz.
FB400KZ or FP400KZ	Sets stop frequencies to 400 kHz.
RE-25DB or RL-25DB	Sets reference level to -25 dBm (if units are set to dBm).
DD5DB	Sets 5dB/div.
RON30DB	Turns level offset ON and sets it to 30 dB.
RB300KZ	Sets RBW to 300 kHz.
VB100KZ	Sets VBW to 100 kHz.
SW200MS	Sets Sweep time to 200 msec.
AT20DB	Sets Attenuator to 20 dB.
PUN100MS	Turns Marker pause ON and sets the time to 100 msec.
DLN87DB	Turns THE display line ON and sets to 87 dB μ V (if units are set to μ dB V).
MK1.8GZ	Turns normal marker ON and sets it to 1.8 GHz.
MT2MZ	Turns delta marker ON and sets normal marker 2 MHz from it.
MN100KZ	Sets the active marker(s) at 100 kHz.
NOISE50Hz	Sets noise power noise width to 50 Hz.
XDB6DB	Sets XdB down width to 6 dB. (This can be also set by the XDL and XDR commands.)
DX10GZ	Sets increment X point of the next peak search to 10. (GZ is entry.)
DY50GZ	Sets increment Y point of the next peak search to 50. (GZ is entry.)
MPM100KZ	Sets marker step size to 100 kHz.
AG 200GZ	Sets average A to 200 times and executes. (GZ is entry.)
BG 300GZ	Sets average B to 300 times and executes. (GZ is entry.)
AD8GZ	Sets the analyzer GPIB address to 8. (GZ is entry.)

Command example	Description
WTF1MZ	Sets window start frequency 1 MHz.
WPF2MZ	Sets window stop frequency to 2 MHz.
WUL-20DB	Sets window upper level to -20 dBm (if units are set to dBm).
WLL-40DB	Sets window lower level to -40 dBm (if units are set to dBm).
CLN-25DB	Sets CAL level to -25 dBm (if units are set to dBm).
SV5GZ SF1	Saves channel 5 (SF1 represents softkey No.1).
RC5GZ SF1/RF5	Recalls channel 5 (Normal/Fast mode).

7. SPLIT-SCREEN (2 SECTIONS) FUNCTION

7.1 Outline of Split-Screen (2 Sections) Function

R3265A/3271A Series provide various display modes by dividing a single screen into two screens (top- and bottom-screen) to display two traces, and make an easy operation for analyzing signals.

(1) Display-mode function

A/B

Displays the trace A to the top screen and the trace B to the bottom screen.

This function is used for analyzing the data in the normal frequency domain and the TIME domain.

(Later, the section A or B of the screen is described; "A" for top section of the screen, "B" for bottom section.

ZOOM/F-domain

In each frequency domain of trace A or B, this function enables to display a wide span on the section B and a zoomed window on the section A.

TIME-domain/F-domain

This function enables to display a frequency domain on the section B and a TIME-domain display of cursor position on the section A.

GATED SWEEP/TIME-domain

This function enables to display a TIME-domain waveform on the section B and a GATED SWEEP waveform on the section A.

DELAYED SWEEP/TIME-domain

This function enables to display a TIME-domain waveform on the section B and a DELAYED-SWEEP waveform on the section A.

(2) Softmenu

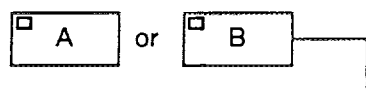

MULTI
SCREEN

During split-screen mode, this menu is display on the following softkeys other than the A or B key so that the screen can be changed easily to the split-screen menu.

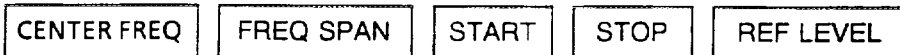

A/B

Use this softkey to enter into the A/B mode.

ZOOM/
F-domain

Use this softkey to enter into the ZOOM/F-domain mode.

T-domain /
F-domain

Use this softkey to enter into the T-domain / F-domain mode.

GATED
SWEEP

Use this softkey to enter into the GATED SWEEP mode.

DELAYED
SWEEP

Use this softkey to enter into the DELAYED SWEEP mode.

MENU LOCK
ON/OFF

Select "ON" or "OFF" to keep the currently displayed menu (ON) or not keep it (OFF) when pressing the trace A or B key.

NORMAL
SCREEN

Use this softkey to cancel the split-screen mode then return to the normal display mode (full screen). In this case, active trace is returned to a full screen

(LED that is lit on the A or B key).

7.2 A/B Mode

This mode enables to individually display the trace A on the top section, and the trace B on the bottom section at the same time.

All the parameters other than the trace modes (WRITE, VIEW, MAX, AVG, etc.) and the detectors (POSI-NEGA, POSI, NEGA, SAMPLE) are commonly used for the section A or B.

The display line and the measuring window are available for the section A only. Marker is displayed on the both sections, however, the number of the marker is same as a full screen and the data is displayed on the section A.

To set up the parameter of the section A, make the section A to be active by pressing the

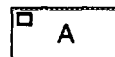

key then perform the normal operation.

Likely, perform the operation for the section B.

In case of A/B mode, only the trace mode and detector mode can be set individually in the section A or B. For marker, an active marker can move between the trace A and the trace B by pressing the A or B key each time.

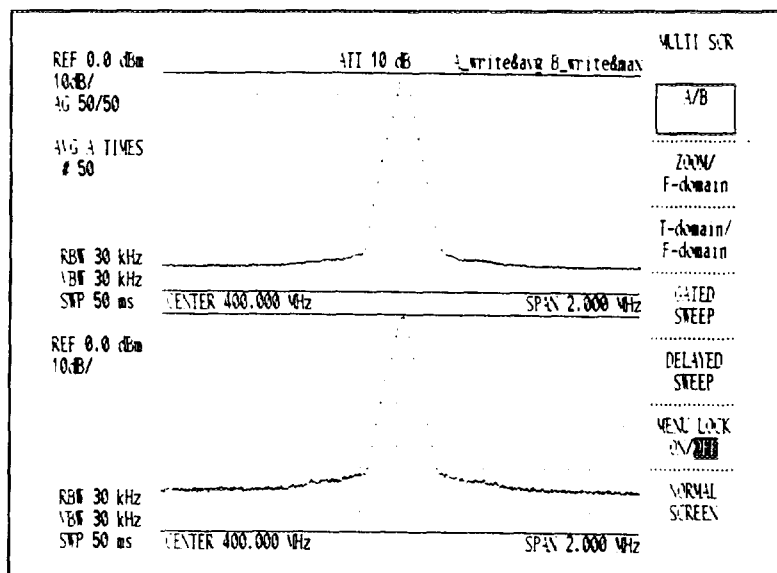

Figure 7 - 1 A/B Mode

(1) Measurement example of A/B mode

Figure 7-2 shows a measurement waveform in a full screen.

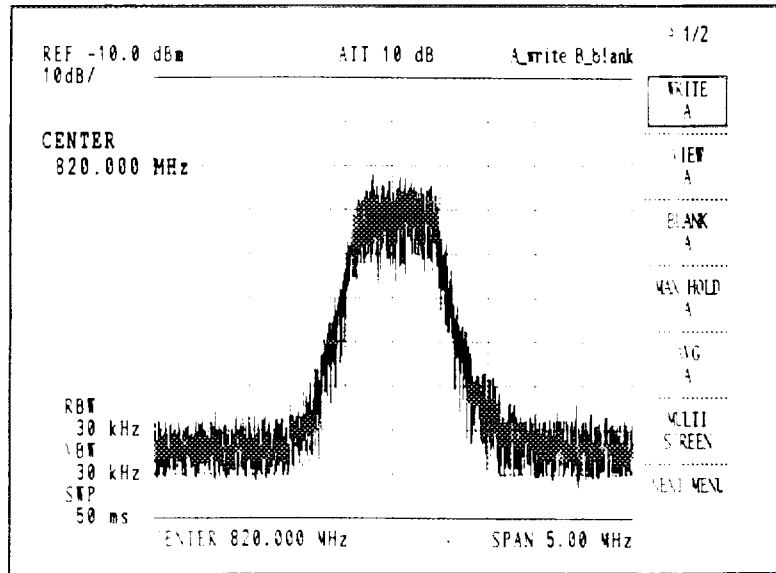

Figure 7 - 2 Full-Screen Display

- ① By pressing the keys in order A, MULTI SCREEN, and A/B, the screen is changed as shown in Figure 7-3.

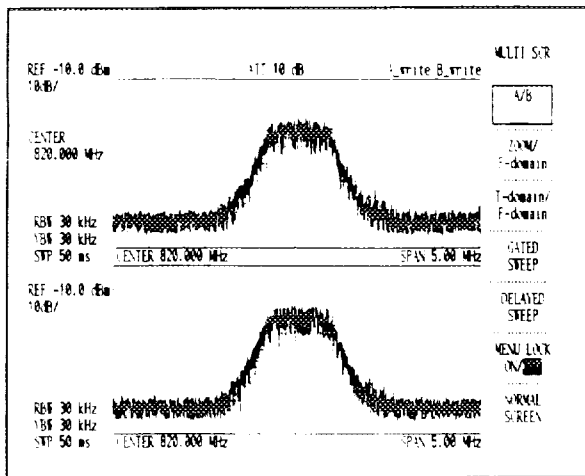

Figure 7 - 3 Split-Screen Display (A/B Mode)

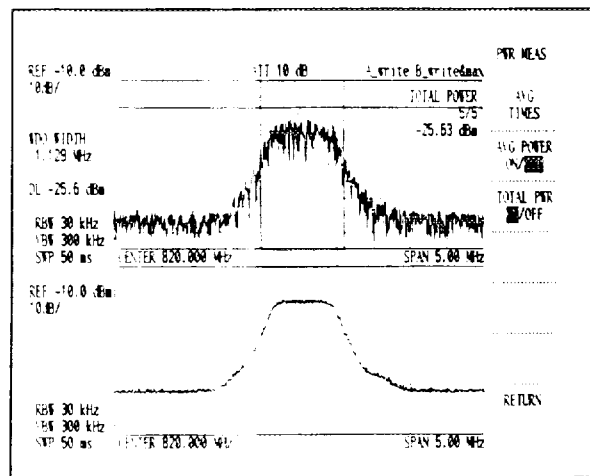
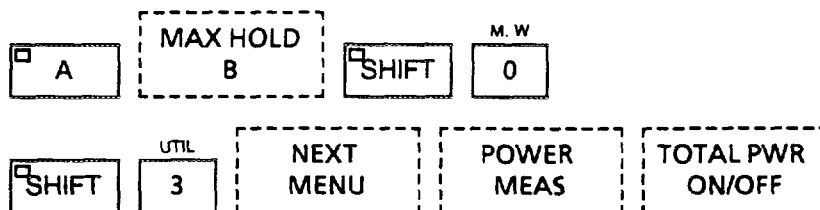

Figure 7 - 4 Measurement Screen in A/B Mode

- ② Press the keys as follows:

(from the screen state of Figure 7-3)



The screen displays the trace B for MAX HOLD, and the trace A for total power measurement as shown in Figure 7-4.

7.3 ZOOM/F-domain Mode

In each frequency domain of trace A or B, this function enables to display a wide span on the section B and a zoomed window on the section A.

By observing a wide frequency range, use this mode to zoom/analyze any signal in that area.

To set up the parameter of the section A, make the section A to be active by pressing the

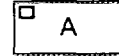

key then perform the normal operation.

Likely, perform the operation for the section B.

In this case, LED on the A or B key lights for an active trace (enable to set).

For the contents of setup parameter and function are commonly used (except the following).

Enable to setup (section A or B individually)

- CENTER, SPAN, and START/STOP frequency
- RBW, VBW, and SWEEP TIME
- REF level, dB/div, LOG/LIN scale, and level unit
- Trace mode, Trigger mode, Detector mode, and QP mode

Enable to setup (section A only)

- Display line and Measuring WINDOW
- Marker and marker related functions (Sound, OBW, ADJ, POWER MEAS, etc.)
- Dummy analog display
- DIGITAL IF

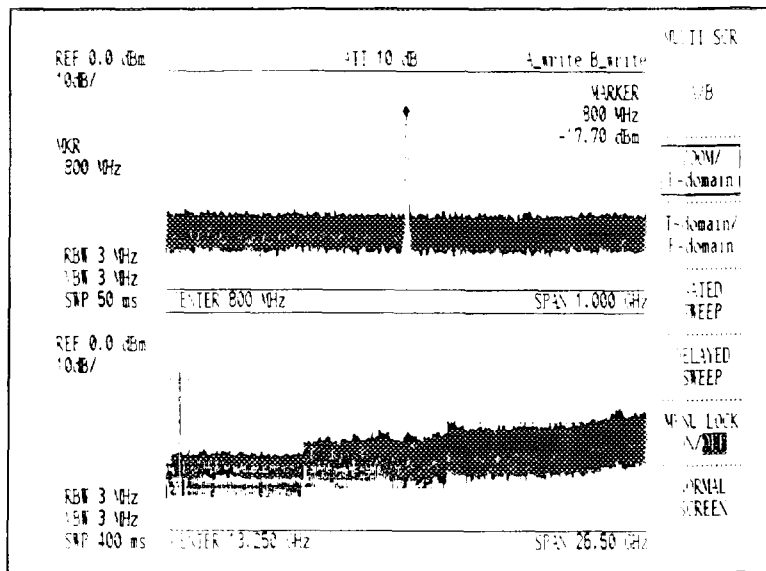
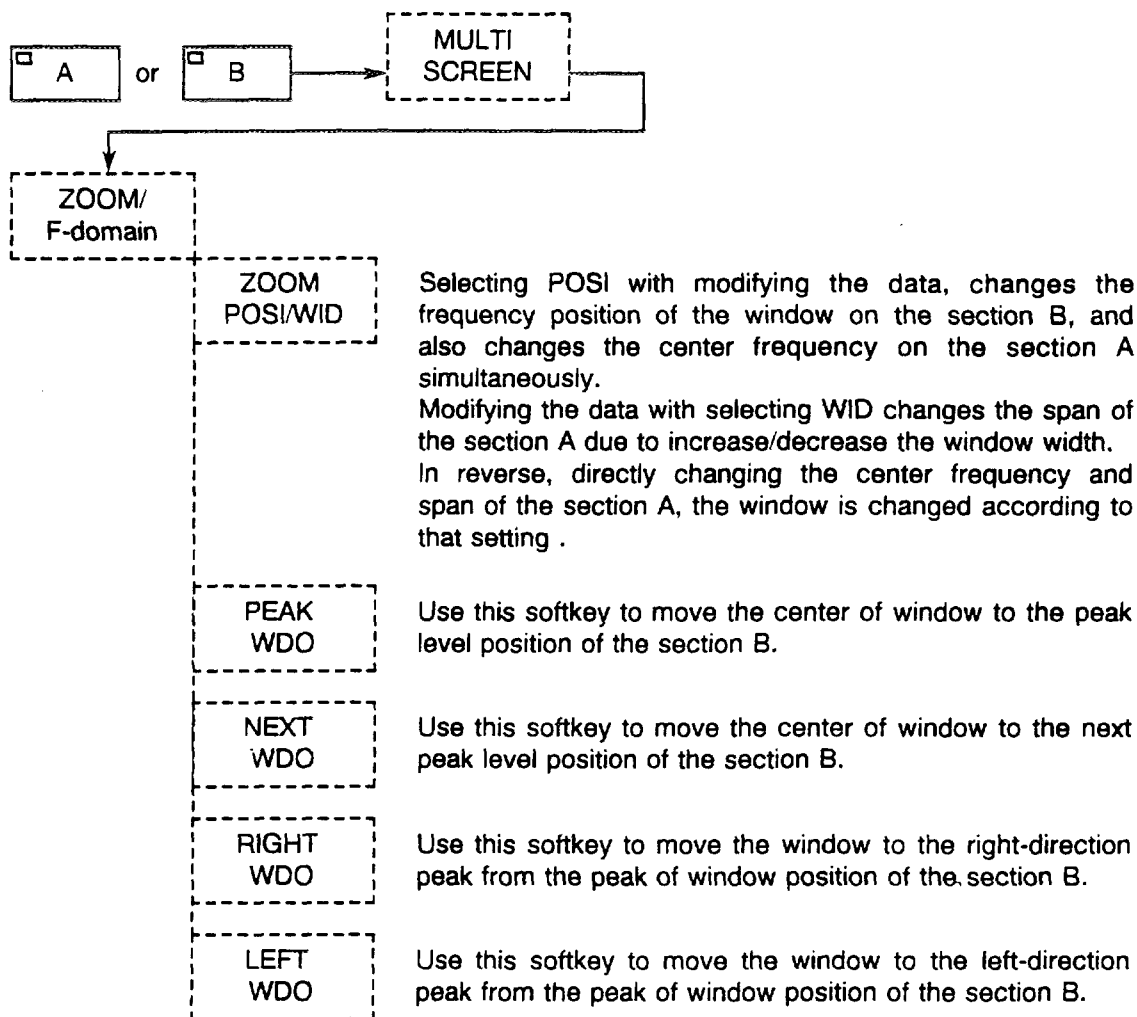

Figure 7 - 5 ZOOM/F-domain Mode

(1) ZOOM/F-domain Softmenu



- When setting the window width to 0 Hz, the R3265A/3271A automatically changes the mode to TIME-domain/F-domain mode. In case of other than 0 Hz, the R3265A/3271A changes the mode to ZOOM/F-domain mode.
- The peak search operation in NEXT WDO/RIGHT WDO/LEFT WDO uses the set value of $\Delta X/\Delta Y$ including NEXT peak function of marker (refer to "(2) $\Delta X/\Delta Y$ Setup" of "5.3.2 Peak Search"). There is no search condition other than $\Delta X/\Delta Y$.
In case of RIGHT or LEFT operation, be sure to reduce the noise width minimum or increase the ΔY setup value maximum (example: 100) due to search the noise.

CAUTION

The following functions cannot be operated in ZOOM/F-domain mode.

- LOG SPAN
- Manual SWEEP and Window SWEEP
- ADJ graph
- GMDSS measurement
- Modulation accuracy measurement (R3541)

(1) Measurement example of ZOOM/F-domain mode

Figure 7-6 shows a measurement waveform example in a full screen.

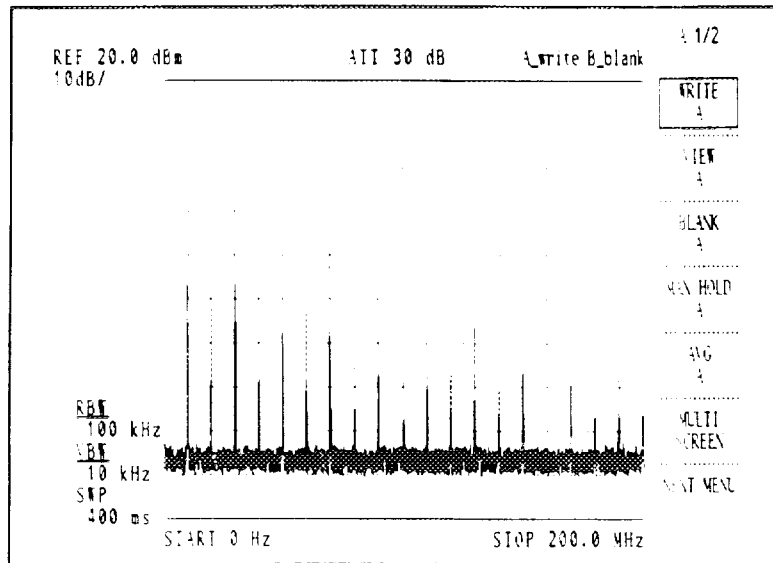

Figure 7 - 6 Full-Screen Display (ZOOM/F-domain Mode)

- ① Press the keys A MULTI SCREEN ZOOM/F-domain in that order to change the screen (see Figure 7-7).

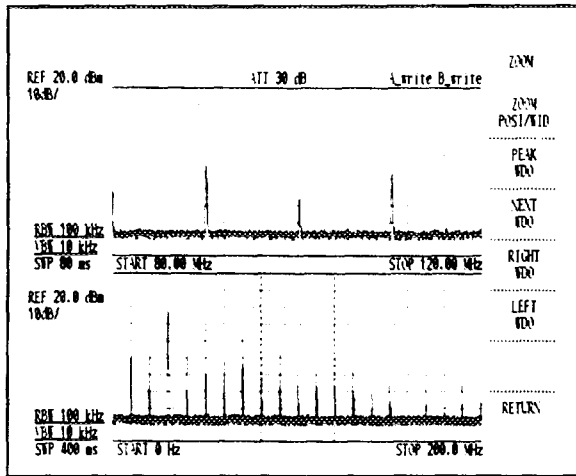

Figure 7 - 7 Split-Screen Display
(ZOOM/F-domain Mode)

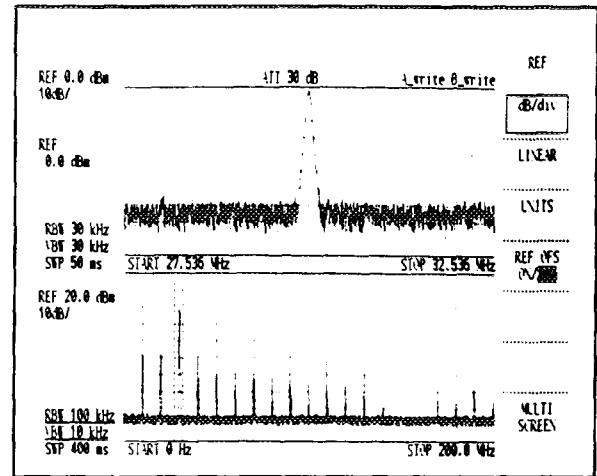

Figure 7 - 8 Measurement Screen in
ZOOM/F-domain Mode

② From the screen state of Figure 7-7

Press the keys: ZOOM
POSI/WID 5 MHz in that order to set the window width.

③ Press the keys PEAK
WDO RIGHT
WDO RIGHT
WDO in that order to move the window position.

④ Press the keys in the following order:

A CPL ALL AUTO REF LEVEL 0 dBm

and then the screen is changed (see Figure 7-8).

Press the B key to make the section B to be active, and then press the

NORMAL
SCREEN to return to the normal screen (see Figure 7-6).

7.4 TIME-domain/F-domain Mode

This function enables to display a frequency domain on the section B and a TIME-domain display of cursor position on the section A.

By observing a wide frequency range, use this mode to analyze any time-axis in that area. The cursor displayed in the section B indicates that the the window width is set to 0 Hz in the ZOOM/F-domain mode.

Parameter setup condition, restriction, and operation method of window are all the same as ZOOM/F-domain mode.

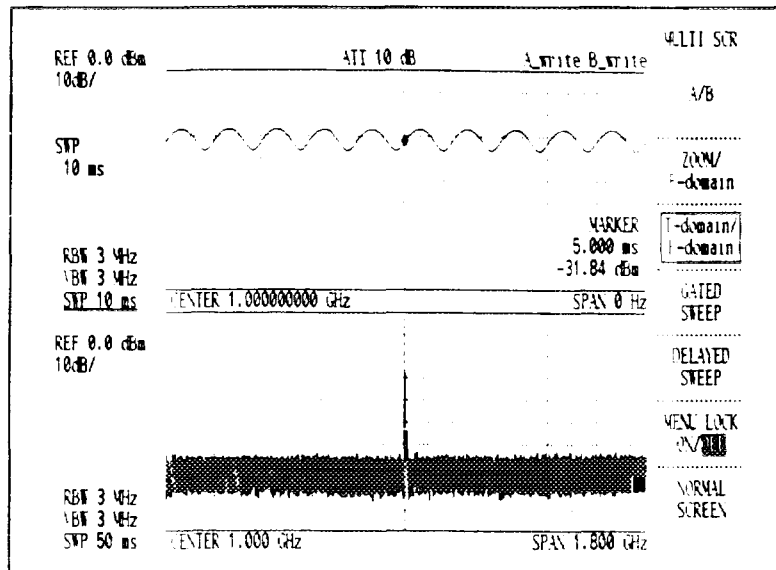

Figure 7 - 9 TIME-domain/F-domain Mode

(1) Measurement example of TIME-domain/F-domain mode

Figure 7-10 shows a measurement waveform example in a full screen.

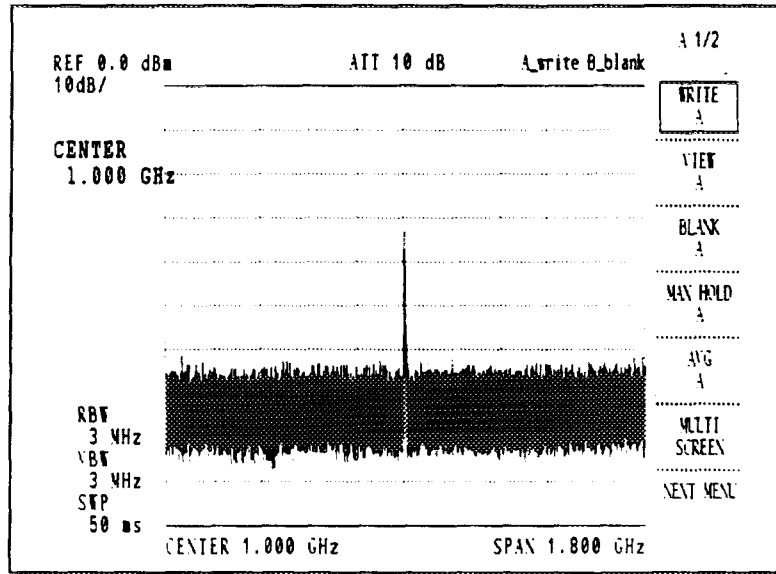

Figure 7 - 10 Full-Screen Display
(TIME-domain/F-domain Mode)

- ① Press the keys A MULTI SCREEN T-domain/F-domain in that order to change the screen (see Figure 7-7).

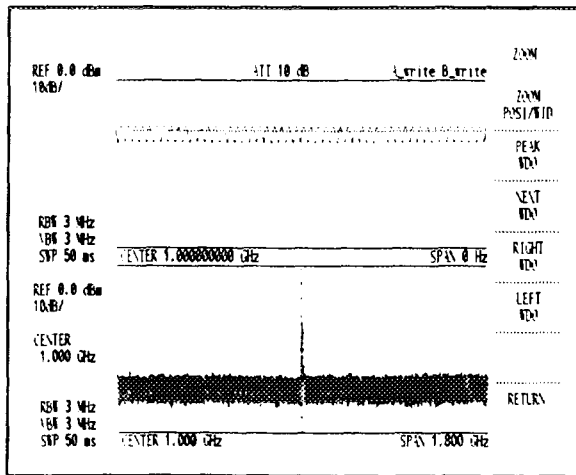

Figure 7 - 11 Split-Screen Display
(TIME-domain/F-domain Mode)

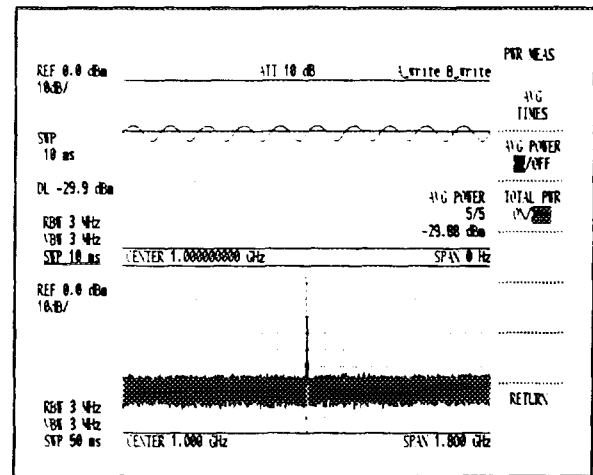
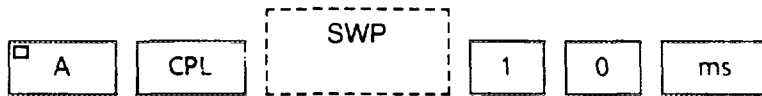

Figure 7 - 12 Measurement Screen in
TIME-domain/F-domain Mode

- ② From the screen state of Figure 7-11

Press the keys in the following order:



and then press the keys in the following order:

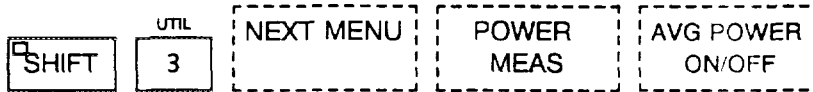

An averaging power measurement can be performed on the section A by observing the frequency domain.

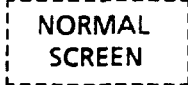
Set the averaging power measurement to OFF, and press the  key to make the section B to be active, and then press the  to return to the normal screen (see Figure 7-10).

7.5 GATED/TIME-domain Mode

This function enables to display a TIME-domain waveform on the section B and a GATED SWEEP on the section A.

The GATED SWEEP waveform can be observed simultaneously with TIME domain waveform so that the burst waveform analysis can be performed effectively.

To set up the parameter of the section A, make the section A to be active by pressing the

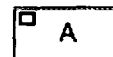

key then perform the normal operation.

Likely, perform the operation for the section B.

In this case, LED on the A or B key lights for an active trace (enable to set).

The following indicates the restriction of parameter setup condition.

Enable to setup (section A or B individually)

- CENTER, SPAN, and START/STOP frequency
- SWEEP TIME
- REF level, dB/div, LOG/LIN scale, and level unit
- Trace mode, Trigger mode, Detector mode, and QP mode

Enable to setup (section A only)

- Display line and Measuring WINDOW
- Marker and marker related functions

Enable to setup (section A or B commonly)

- RBW, VBW and other than above

(1) GATED SWEEP function

GATED SWEEP can be generated with generating any gate signal from the trigger signal source internally.

The trigger signal source in the frequency domain analysis uses the external trigger input, the gate input, and the IF DETECTOR trigger. In case of TIME domain, uses the external trigger input, the gate input, the VIDEO trigger, the TV-V trigger, and the IF DETECTOR.

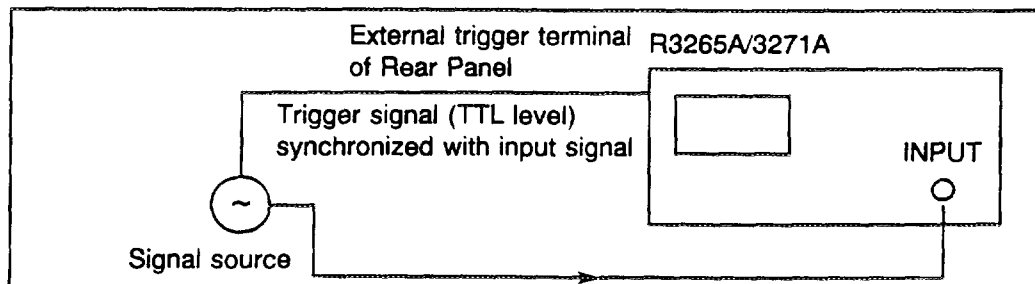

Figure 7 - 13 Connecting the GATED SWEEP

Figure 7-14 (full-screen mode) shows the waveform measured on the normal full-screen mode without GATED SWEEP.

Figure 7-15 (split-screen mode) shows the TIME domain waveform on the section B, the normal waveform on the section A (GATED SWEEP OFF).

The window is displayed on the TIME domain waveform of the section B. Move the window to the destination area to be gated and then select the trigger source by SOURCE EXT/INT.

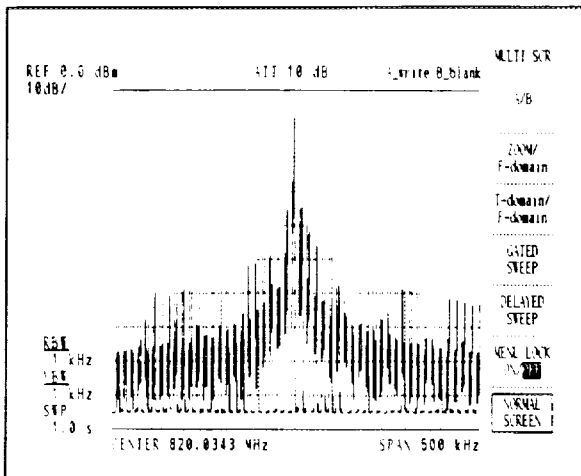

Figure 7 - 14 Full-Screen Display
(GATED SWEEP OFF)

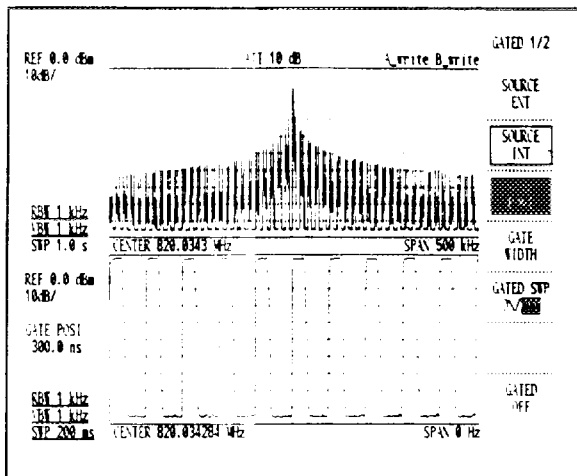

Figure 7 - 15 Split-Screen Display
(GATED SWEEP OFF)

Figure 7-16 (split-screen mode) shows the TIME domain waveform on the section B, the normal waveform on the section A.

Figure 7-17 (full-screen mode) shows the waveform displayed on the normal full-screen with GATED SWEEP ON.

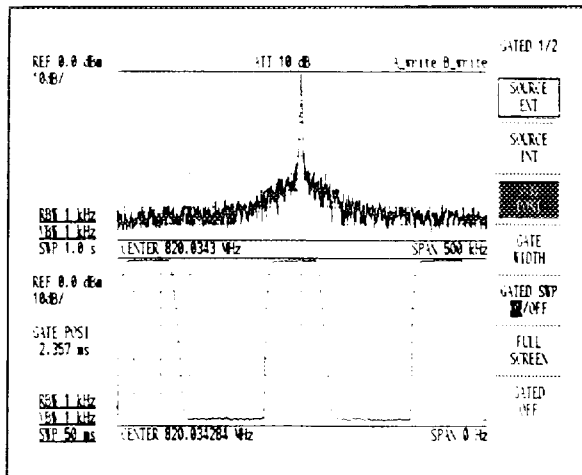

Figure 7 - 16 Split-Screen Display
(GATED SWEEP ON)

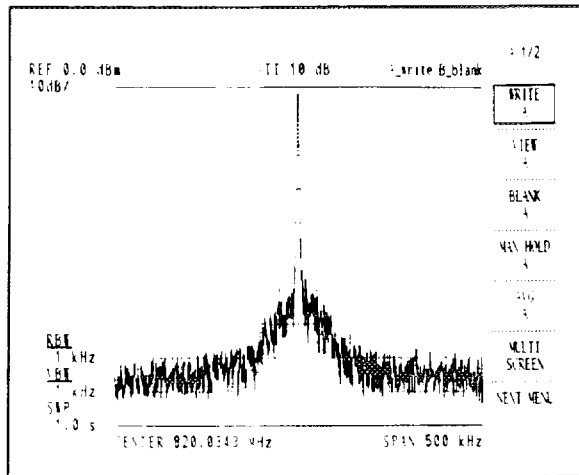
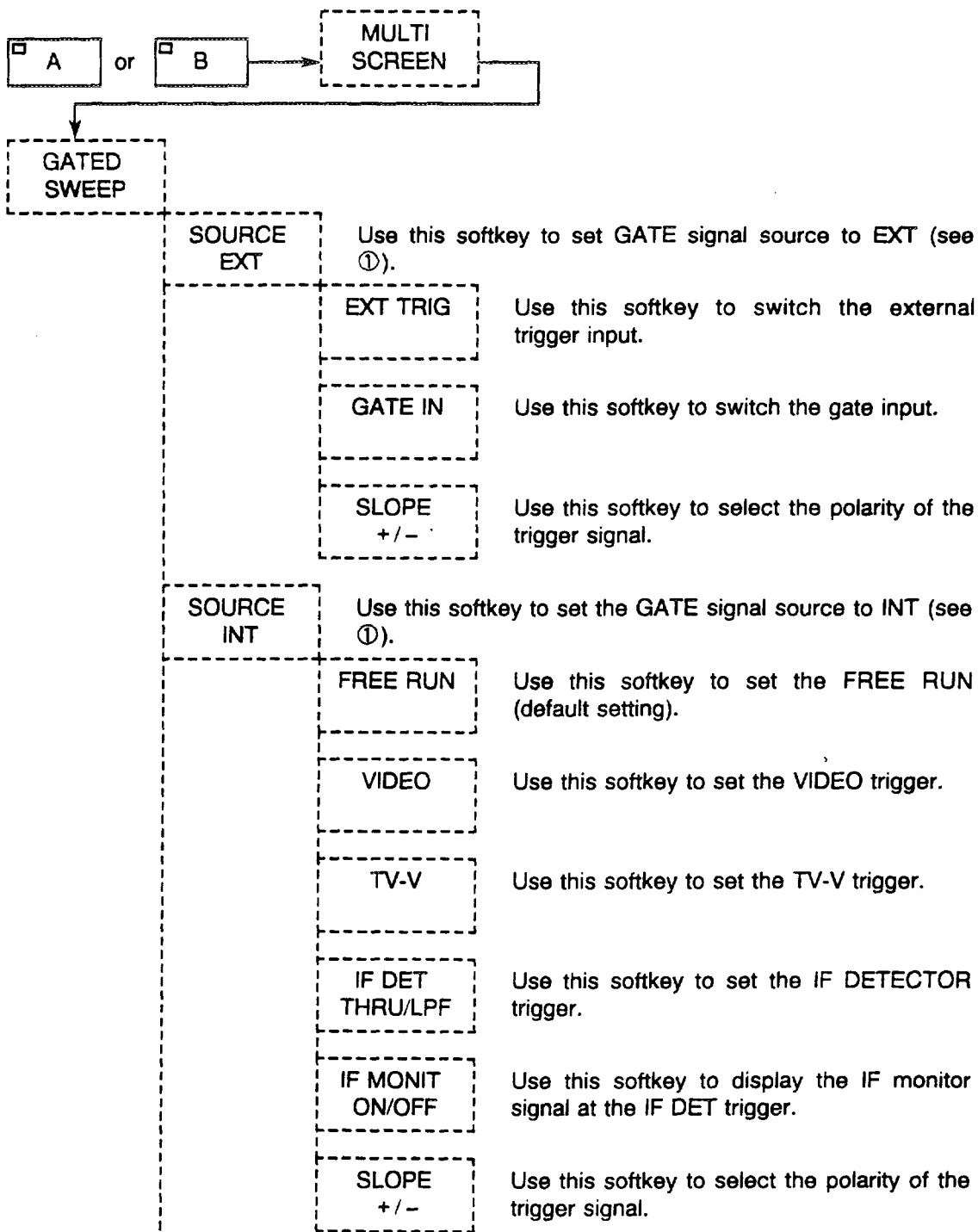

Figure 7 - 17 Full-Screen Display
(GATED SWEEP ON)

(2) GATED SWEEP Softmenu



GATE POSI	Use this softkey to set the window position (see ②).
GATE WIDTH	Use this softkey to set the window width (see ②).
GATED SWP ON/OFF	Use this softkey to switch the GATED SWEEP ON/OFF (see ③).
FULL SCREEN	Use this softkey to display the waveform of the section A (when GATED SWEEP ON) using the full screen.
GATED OFF	Use this softkey to cancel the GATED SWEEP mode and then return to the normal full-screen display.

- ① Press the keys in the order SOURCE
EXT , SOURCE
INT .

Enables to set the GATE signal source for the TIME domain waveform of the trace B.

In case of SOURCE INT, GATE signal is defined as trigger signal (VIDEO trigger signal for VIDEO, TV-V trigger signal for TV-V, and IF monitor signal for IF DET).

Perform each adjustment for the trigger level (left arrow of the screen) and the polarity of the trigger signal (raise: +). However, fix the polarity of GATE input to "+".

LPF is set by IF DET trigger, and the THRU can be set by passing through LOW PASS filter. The LPF can be used if much noise factor is generated.

When the IF MONITOR is set to ON in IF DET trigger, IF monitor signal is displayed.

When the IF MONITOR is set to OFF, the input signal is displayed by IF DET trigger.

- Note:
- Frequency domain cannot be analyzed in VIDEO trigger and TV-V trigger.
 - SPAN 5 MHz or more cannot be used for analyzing the frequency domain in IF DET trigger.
 - Trigger selection by pressing the keys MENU → TRIG , enables to

set for the GATED SWEEP waveform of the trace A.

- ① Press the keys in the order

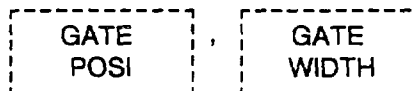

Enables to change the window position and width. Move the window to the destination area to be gated on the TIME domain waveform of trace B. The resolution can be set with a unit of 100 ns according to SWEEP TIME.

GATE POSI

Enables to move the window fixed to left/right direction.

The setting range is from 300 ns to 100 ms. (default value: 300 ns)

GATE WIDTH

Enables to increase/decrease the width from the center of the window position.

The setting range is from 100 ns to 1.5 sec. (default value: 1 us)

Set the TRACE DET to the SAMPLE when using the window width of 10 us or less.

- Note:
- The window can be displayed when the trace B is set to zero span.
 - The setting of data displayed can be performed, even if that data is out of the screen.

- ③ Press the

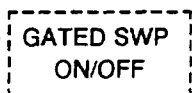

ON : The area that is set by the window is gated and then the GATED SWEEP is set to ON.

During ON condition, the burst waveform of the trace A can be analyzed simultaneously.

The setting of the trigger level (→) and the polarity (+/-) of trigger signal are fixed.

OFF : Sets the GATED SWEEP to OFF.

(3) Measurement example of GATED/TIME-domain mode

Figure 7-18 shows a measurement waveform in a full screen.

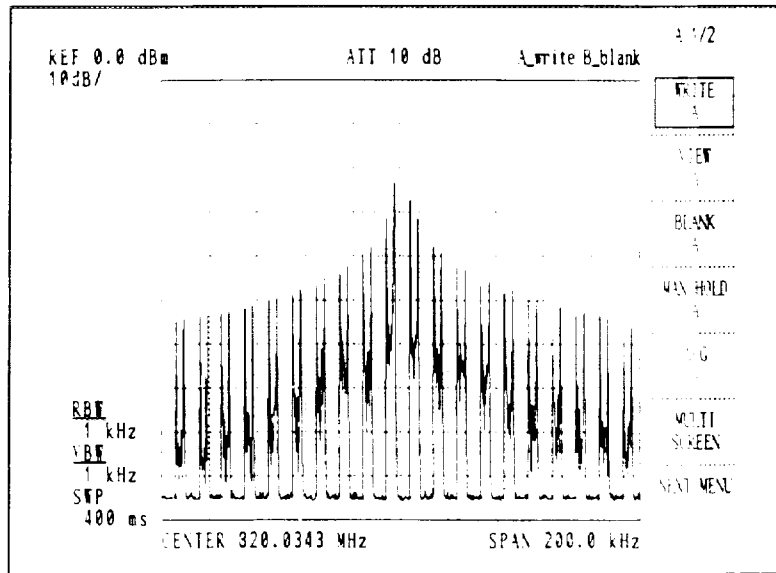
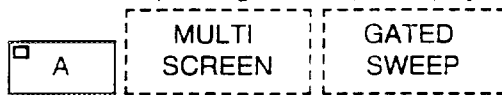

Figure 7 - 18 Full-Screen Display

- ① The screen (see Figure 7-19) is displayed by pressing the keys in order



- ② Press the keys in order SOURCE EXT EXT TRIG from the state (see Figure 7-19), and set to EXT trigger.

- ③ Press the keys as follows:

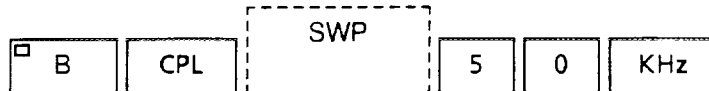

and adjust the GATE POSI and GATE WIDTH .

④ Press the **GATED SWP** /OFF key after moving the window to the destination area to be gated, the screen (see Figure 7-20) will be displayed.

Select the **A** key to make active and then press the **GATE OFF** key, the screen will return to the previous screen (see Figure 7-18).

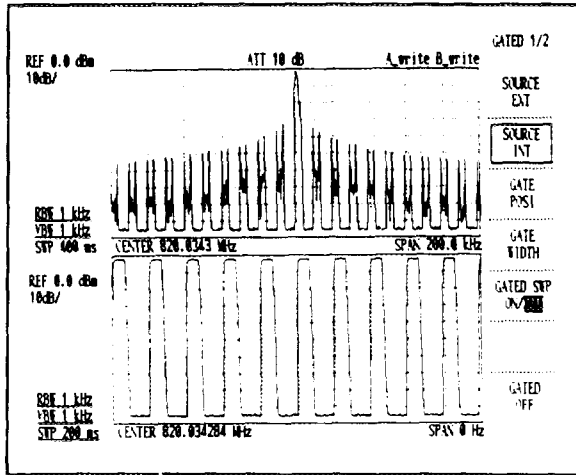

Figure 7 - 19 Split-Screen Display
(GATED/TIME-domain Mode)

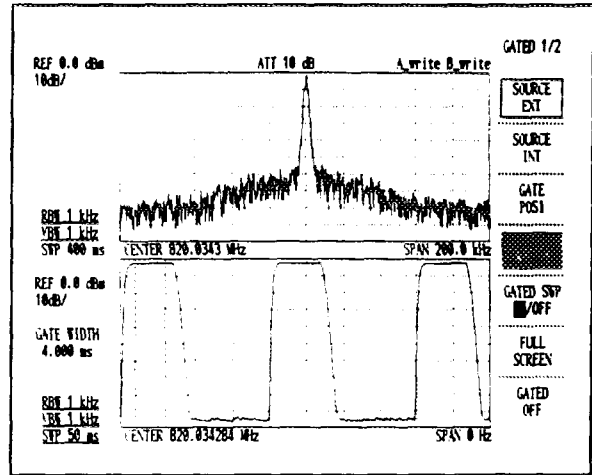

Figure 7 - 20 Measurement Screen in
GATED/TIME-domain Mode

7.6 DELAYED/TIME-domain Mode

This function enables to display a TIME-domain waveform on the section B and a DELAYED SWEEP on the section A.

The DELAYED SWEEP waveform can be observed simultaneously with an original TIME domain waveform. Therefore, it is effectively for analyzing the signal (rise/fall)

To set up the parameter of the section A, make the section A to be active by pressing the

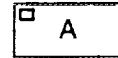

key then perform the normal operation.

Likely, perform the operation for the section B.

In this case, LED on the A or B key lights for an active trace (enable to set).

The following indicates the restriction of parameter setup condition.

Enable to setup (section A or B individually)

- SWEEP TIME
- REF level, dB/div, LOG/LIN scale, and level unit
- Trace mode, Detector mode, and QP mode

Enable to setup (section A only)

- Display line and Measuring WINDOW
- Marker and marker related functions

Enable to setup (section A or B commonly)

- CENTER, SPAN, START/STOP frequency
- RBW, VBW and other than above
- Trigger mode (trigger level, + / -)
- Other than above

(1) GATED SWEEP function

TIME domain waveform can be observed after any time from the trigger signal source.

Trigger signal source uses the VIDEO trigger, the TV-V trigger, and the external trigger input.

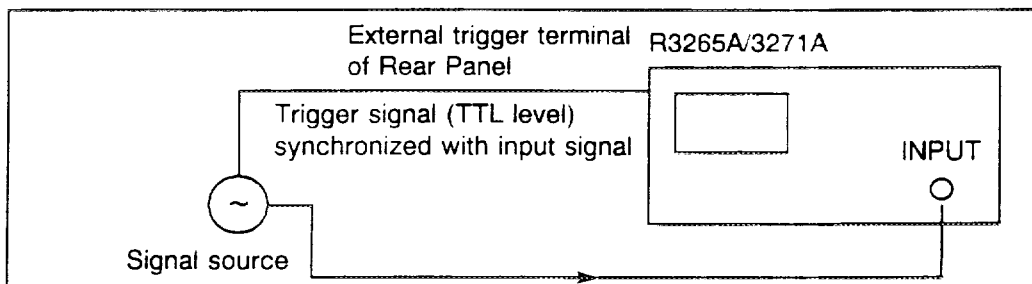

Figure 7 - 21 DELAYED SWEEP Connection Diagram

Figure 7-22 (full-screen mode) shows the waveform measured on the normal full-screen mode without DELAYED SWEEP.

Figure 7-23 (split-screen mode) shows the original TIME domain waveform on the section B, and the waveform (DELAYED SWEEP OFF) on the section A.

The window is displayed on the section B. Move the window to the destination area to be zoomed and then select the trigger source.

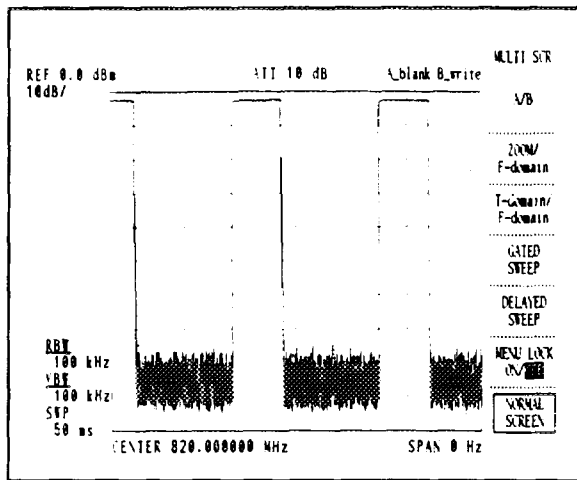

Figure 7 - 22 Full-Screen Display
(DELAYED SWEEP OFF)

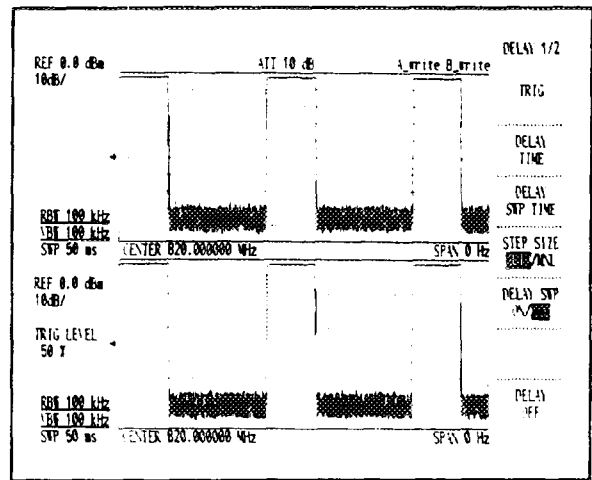

Figure 7 - 23 Split-Screen Display
(DELAYED SWEEP OFF)

Figure 7-24 shows the DELAYED SWEEP ON condition.

The zoomed waveform in the window is displayed on the section A.

Figure 7-25 shows the waveform with the DELAYED SWEEP ON condition on the normal full-screen.

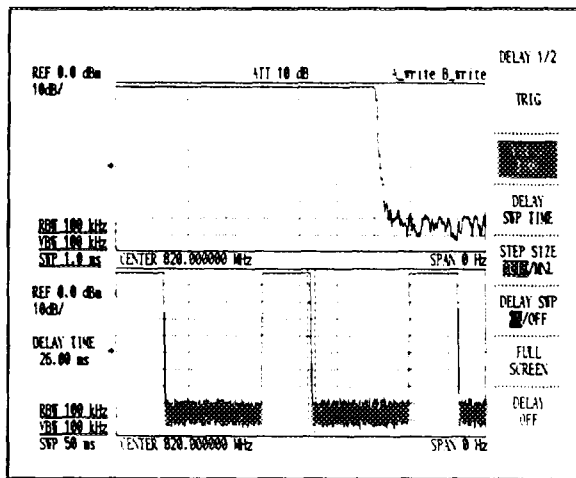

Figure 7 - 24 Split-Screen Display
(DELAYED SWEEP ON)

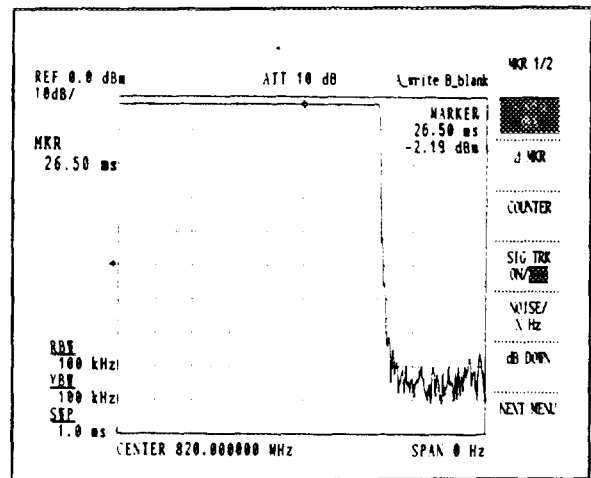
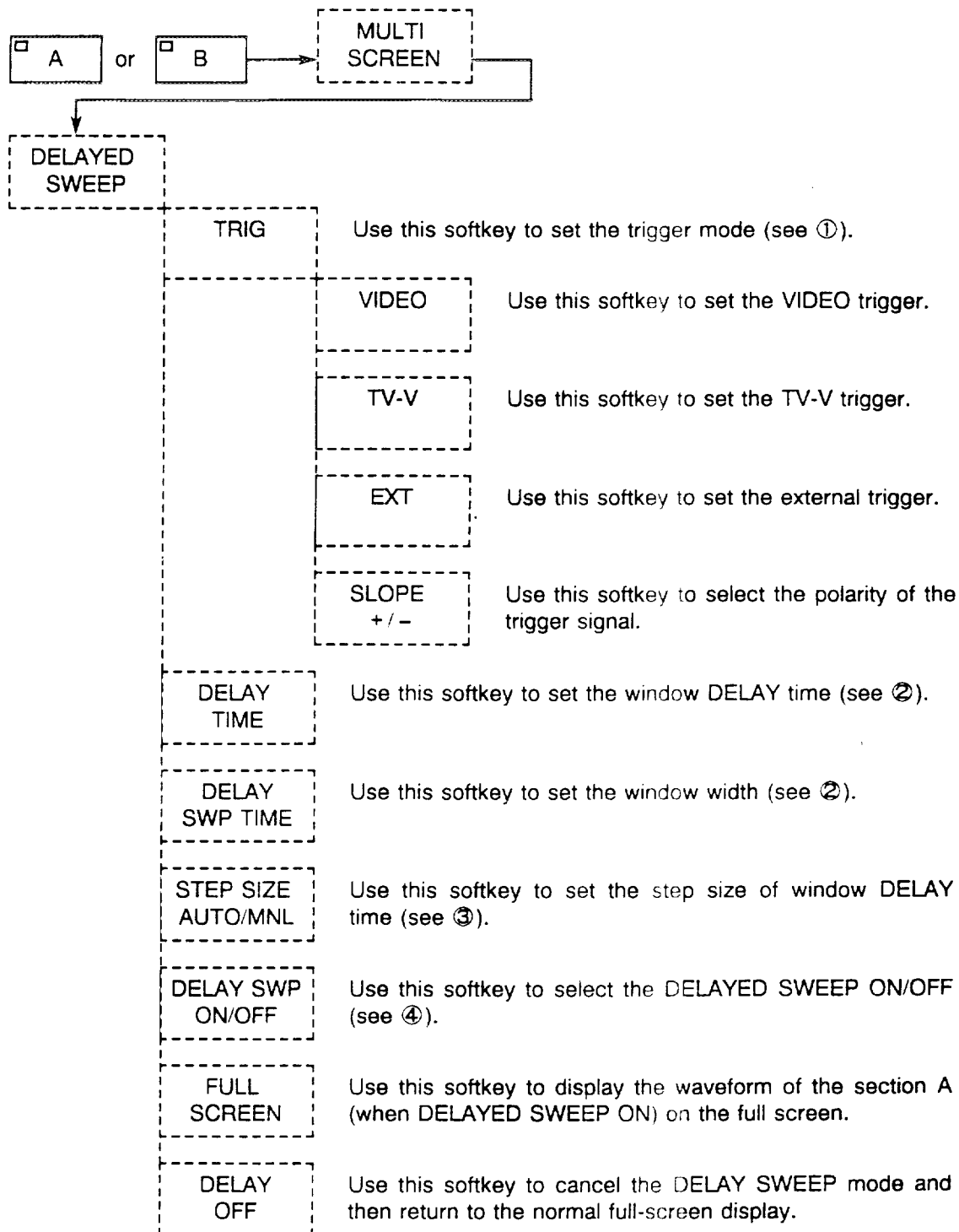

Figure 7 - 25 Full-Screen Display
(DELAYED SWEEP ON)

(2) DELAYED SWEEP Softmenu



- ① Press the TRIG key.

Selects any one of triggers (VIDEO, TV-V, EXT).

Adjusts/triggers the trigger level (upper-left arrow (→) of screen) and the polarity (leading edge: +) of trigger signal. The trigger can be set to the both traces (A, B).

- ② Press the keys in order DELAY
TIME DELAY
SWP TIME

Enables to change the delay time and width of the window. Move the window to the destination area to be zoomed on TIME domain waveform of the trace B.

DELAY TIME

Enables to move the window width fixed to left/right direction.

The setting of resolution according to SWEEP TIME, can be specified up to 100 ns using numeric key.

The setting range is from 200 ns to 1.5 sec. (default value: 200 ns)

DELAY SWP TIME

Enables to increase/decrease the window width (right-side line only) with keeping the DELAY TIME fixed.

Resolution is same as SWEEP TIME.

The setting range is from 50 us to 1000 sec.

- Note:
- The window can be displayed when the trace B is set to zero span.
 - The setting of data displayed can be performed, even if that data is out of the screen.

- ③ Press the STEP SIZE
AUTO/MNL key.

Enables to set the step size when moving the DELAY TIME of window using the step key.

AUTO: 1/10 (one-tenth) of SWEEP TIME automatically

MNL : Manual setting from 100 ns to 1 sec.

- ④ Press the DELAY SWP
ON/OFF

ON : Triggers from DELAY TIME of window, and the window width is set to SWEEP TIME to display the waveform zoomed of the window on the trace A.

When "ON" is selected, enables to simultaneously analyze the DELAYED SWEEP waveform on the trace A with changing the window setting.

OFF : Sets the DELAYED SWEEP to OFF.

(3) Measurement example of DELAYED/TIME-domain mode

Figure 7-26 shows a measurement waveform in full-screen display.

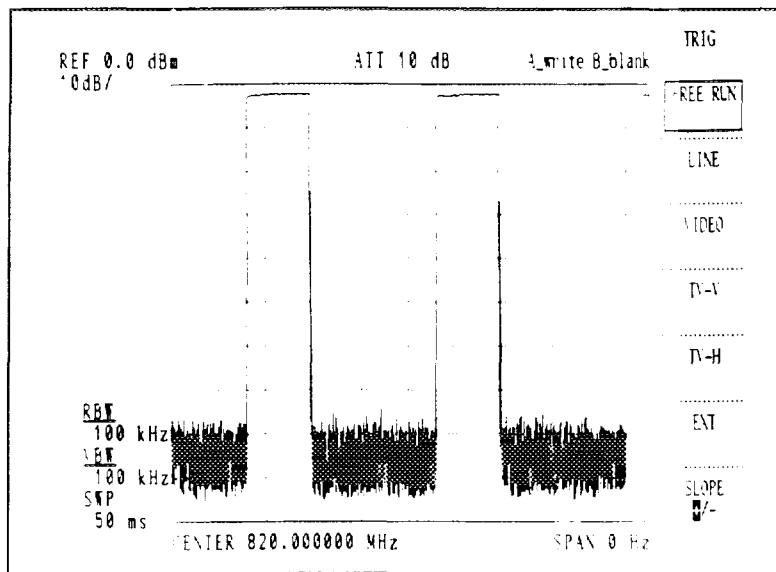
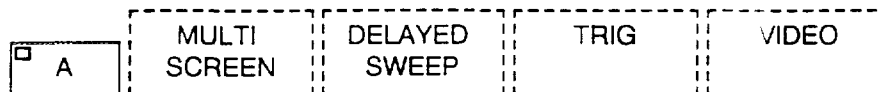

Figure 7 - 26 Full-Screen Display

- ① Press the keys in the following order:



and then the screen (see Figure 7-27) will be displayed. (In this case, adjust the trigger level.)

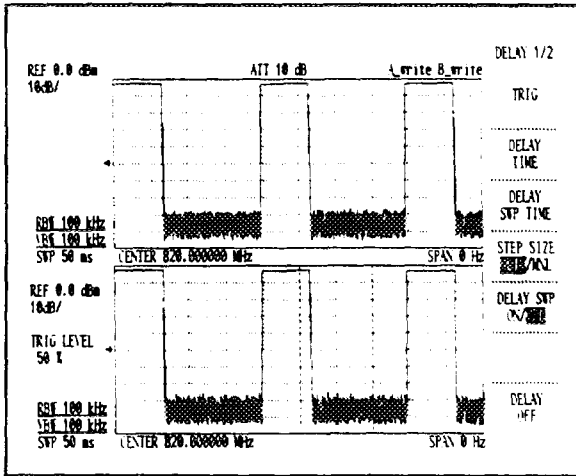

Figure 7 - 27 Split-Screen Display
(DELAYED/TIME-domain Mode)

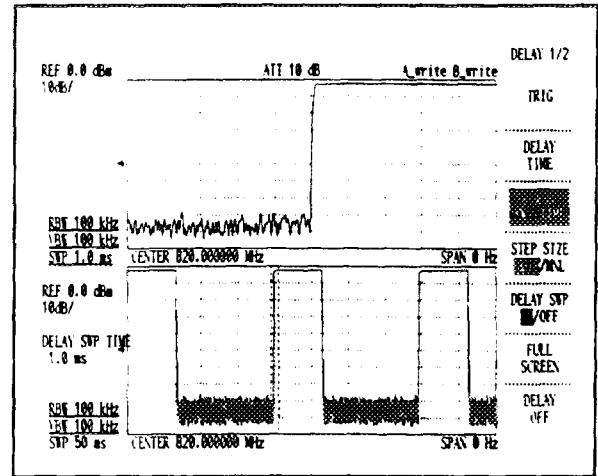

Figure 7 - 28 Measurement Screen in
DELAYED/TIME-domain Mode

② Press the keys in order DELAY TIME DELAY SWP TIME from the screen state (see Figure 7-27) to adjust the data, and move the window to the destination area to be zoomed, then press the DELAY SWP ON /OFF key to select "ON". The screen (see Figure 7-28) will be displayed.

The window can be moved when DELAY SWEEP is set to ON, therefore, fine adjustment can be performed.

Press the B key to make the section B to be active, and then press the

DELAY OFF key to return to the normal screen (see Figure 7-26).

7.7 GPIB Programming Examples(HP300 Series)

(1) A/B Mode

10 OUTPUT 708;"CF800MZ; SP10MZ"	' Sets the CENTER and SPAN.
20 OUTPUT 708;"MLTSCR AB"	' Sets the A/B mode.
30 OUTPUT 708;"BMAX; AAVG"	' Selects the MAX HOLD for the trace B.and the AVG for the trace B.
40 END	

(2) ZOOM/F-domain Mode

10 OUTPUT 708;"FA0MZ; FB200MZ; RB100KZ; VB10KZ"	' Sets the start/stop frequencise,and RBM.
20 OUTPUT 708;"MLTSCR ZOOM"	' Sets the ZOOM mode.
30 OUTPUT 708;"ZOOM WID 5MZ"	' Sets the window width.
40 OUTPUT 708;"ZOOM HI; ZOOM NR; ZOOM NR"	' Moves the window to the PEAK,RIGHT,RIGHT in order.
50 OUTPUT 708;"TA; AL; RE-20DB"	' Selects the ALL AUTO (CPL of the section A),then sets the REF level.
60 OUTPUT 708;"TS"	' Executes the single SWEEP once.
70 OUTPUT 708;"PS; CNO"	' Executes the peak search,then sets the counter ON.
80 END	

(3)ZOOM/TIME-domain Mode

10 OUTPUT 708;"CF1GZ; SP1.8GZ"	' Sets the CENTER and SPAN.
20 OUTPUT 708;"MLTSCR ZOOM"	' Sets the ZOOM mode.
30 OUTPUT 708;"ZOOM WID 0HZ"	' Sets the windou width to 0 HZ
40 OUTPUT 708;"ZOOM HI"	' Moves the window to the PEAK.
50 OUTPUT 708;"TA; SW10MS"	' Sets the SWEEP time of the section A.
60 OUTPUT 708;"PWAvg ON"	' Sets the averaging power measurement to ON.
70 END	

(4) GATED/TIME-domain Mode(See Note below)

10 OUTPUT 708;"CF820MZ; SP200KZ; RB1KZ; VB1KZ"	' Sets the CENTER,SPAN,RBW,and VBW.
20 OUTPUT 708;"EXT GT"	' Sets the GATE signal source to EXT(external).
30 OUTPUT 708;"TB; SW50MS"	' Sets the SWEEP time of the section B.
40 OUTPUT 708;"GTWID 4MS; GTPos 2MS"	' Sets the GATE width and position.
50 OUTPUT 708;"GTSWP ON"	' Sets the GATED SWEEP to ON.
60 END	

Note: For the sample programs (4),the full-screen display is set during a GPIB operation.

(5) DELAYED/TIME-domain Mode(See Note below)

10 OUTPUT 708;"CF820MZ; SPOKZ; RB10KZ; VB10KZ"	' Sets the CENTER,SPAN,RBW,and VBW.
20 OUTPUT 708;"VIDEO DLY"	' Select the VIDEO trigger.
30 OUTPUT 708;"TR80HZ"	' Sets the trigger level to 80%.
40 OUTPUT 708;"DLYTIM 7MS; DLYSWTIM 1MS"	' Sets the DELAY time and width.
50 OUTPUT 708;"DLYSWP ON"	' Sets the DELAYED SWEEP to ON.
60 END	

Note: For the sample programs (5),the full-screen display is set during a GPIB operation.

8. TROUBLESHOOTING

This chapter to diagnose and solve any problems you may have with your analyzer.



8.1 Inspection and Diagnosis

If you have problems with your analyzer, use the table below to find the problem and possible solution. If the solutions don't solve the problem, contact ATCE or the nearest dealer or the sales and support offices. The addresses and telephone numbers are listed at the end of this manual. You will be charged for all repairs done by our engineers.

Condition	Possible Cause	Solution
The system cannot be powered up.	The power cable is not properly inserted in the connector.	Turn the power switch off and connect the power cable properly.
	The power fuse is blown.	Replace the power fuse. (See paragraph 1.2.4-(2).)
The sweep LED lamp is lit but no waveform is displayed on the screen.	The intensity volume is set too low.	Adjust the intensity using the volume knob.
	The input cable or connector is not properly connected.	Connect the input cable and connector properly.
The analyzer will not sweep.	The trigger is set to Single mode.	Press the menu key and select FREE RUN.
	The LED lamp corresponding to key A or B is not lit.	Press the key A or B of TRACE and select WRITE.
The signal level is inaccurate.	The AMPTD CAL has not been adjusted.	Perform calibration (See section 5.8).
The keys do not function.	The system is set to the GPIB remote control mode.	If a program is being executed, halt it and press the LCL key.

9. THEORY OF OPERATION

This section explains at the block level how the R3265A/3271A spectrum analyzer works.



9.1 Block Descriptions

The R3265A/3271A mixes the input signal with a 21.4 MHz intermediate frequency (IF) signal. (The input signal must be in the range from 100 Hz to 8 GHz for the R3265A, and in the range from 100 Hz to 26.5 GHz for the R3271A.) The signal is then filtered with a variable-resolution bandwidth 21.4 MHz IF filter. The detector detects the signal, and the signal is digitized and displayed on the screen.

(1) Mixer Section

Input Frequencies from 100 Hz to 3.6 GHz

In the range from 100 Hz to 3.6 GHz, the input signal is fed through the input attenuator (which can attenuate 0 to 70 dB in 10 dB steps) and into the first mixer. The signal then mixes with the partial oscillation signal, which is synthesized by the YIG tuning oscillator operating at 4.2 GHz to 7.8 GHz. This creates the first IF signal with a frequency of 4231.4 MHz.

The first IF signal passes through the low noise amplifier (LNA), then to the band pass filter (BPF) to eliminate spurious signals generated by the first and second mixers. (Note that the R3271A does not use the LNA.)

From the band pass filter, the signal passes to the second mixer. There it mixes with a 3810 MHz signal from a phase-locked second partial oscillator, and converts into the second IF signal with a frequency of 421.4 MHz.

Input Frequencies 3.5 GHz and Above

In the range of 3.5 GHz and above, the signal passes through the input attenuator to the tracking filter (a YIG tuning filter), which operates synchronously with the spectrum analyzer tuning frequency. This eliminates images and multiple response from the signal before the signal is fed into the first mixer.

The signal then passes into the first mixer and mixes with the synthesized partial oscillation signal of 3.9 GHz to 8 GHz. This creates the 421.4 MHz IF signal.

This 421.4 MHz IF signal then passes through a bandpass filter (to eliminate the image generated by the third mixer) and on to the third mixer, where it mixes with the partial oscillation signal of 400 MHz to create the IF signal of 21.4 MHz. (The third partial oscillation signal of 400 MHz is generated by doubling the signal from the 200 MHz oscillator, which is phase-locked to the 10 MHz reference oscillator.)

(2) IF Section

The 21.4 MHz signal from the mixer section is fed into the IF filter, which has a variable resolution bandwidth from 10 Hz to 3 MHz. The IF section contains a step amplifier (with a 0.1 dB step) to determine the reference level.

The bandwidth filter consists of four stages of 21.4 MHz LC filters, and has a resolution of 300 kHz to 3 MHz. In the range from 100 kHz to 10 Hz, the 21.4 MHz signal is converted to a frequency of 3.58 MHz and fed through the next IF filter. (The 1 kHz to 10 Hz IF filter consists of four stages of crystal oscillators.) The signal is then converted back to a frequency of 21.4 MHz.

(3) LOG A/D Section

After the IF section determines the signal's resolution bandwidth, the signal is fed through the logarithmic (LOG) amplifier, which provides a 100-dB dynamic range if the level is displayed in decibels. If the level is to be displayed linearly, the signal passes through the linear amplifier and on to the detector (DEC). After detection, the signal is digitized by the A/D converter. The digital signal is then manipulated by a CPU and displayed on the screen.

9.2 Block Diagram

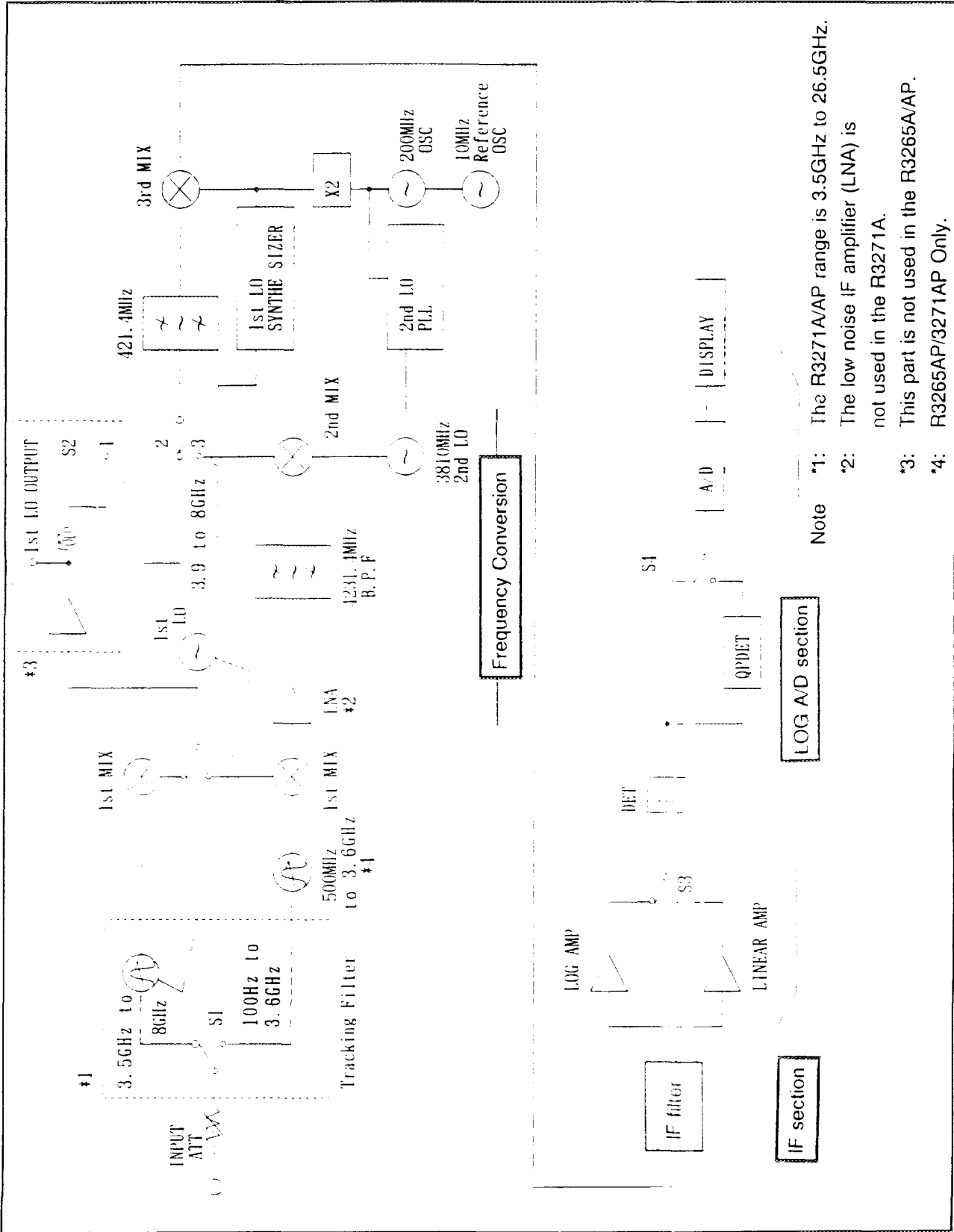

10. SPECIFICATIONS

This chapter describes the specifications and accessories for the R3265A/3271A SERIES.

10.1 R3265A/3365A Specifications

(1) Frequency Characteristics

● Frequency range	100Hz to 8GHz Frequency band 100Hz to 3.6GHz 3.5GHz to 7.5GHz 7.4GHz to 8GHz	Harmonic mode (n) 1 1 1															
● Frequency read accuracy (Start, Stop, Center frequency, Marker frequency)	$\pm (\text{Frequency reading} \times \text{Frequency reference accuracy} + \text{Span} \times \text{Span accuracy} + 0.15 \times \text{Resolution bandwidth} + 10\text{Hz})$ Span accuracy (Span > 2MHz) $\pm 3\%$ (Span \leq 2MHz) $\pm 5\%$																
● Marker frequency counter Resolution Accuracy (S/N $\geq 25\text{dB}$) Delta counter accuracy	1Hz to 1kHz $\pm (\text{Marker frequency} \times \text{Frequency reference accuracy} + 5\text{Hz} + 1\text{LSD})$ $\pm (\Delta\text{frequency} \times \text{Frequency reference accuracy} + 10\text{Hz} + 2\text{LSD})$																
● Frequency reference accuracy	$\pm 2 \times 10^{-8}$ /Day $\pm 1 \times 10^{-7}$ /Year																
● Frequency stability Residual FM (Zero span) Drift (After 1 hour warm-up)	$< 3\text{Hz} \times N_{p.p} / 0.1\text{sec}$ $50\text{kHz} < \text{Span} \leq 2\text{MHz}, < 2.5\text{kHz} \times \text{Sweep speed (min.)} \times N$ $\text{Span} \leq 50\text{kHz}, < 60\text{Hz} \times \text{Sweep speed (min.)} \times N$																
● Signal purity noise side band	<table border="1"> <thead> <tr> <th>Offset</th> <th>f $\leq 2.6\text{GHz}$</th> <th>f > 2.6GHz</th> </tr> </thead> <tbody> <tr> <td>1kHz</td> <td>< -100dBc/Hz</td> <td>< -95dBc/Hz</td> </tr> <tr> <td>10kHz</td> <td>< -110dBc/Hz</td> <td>< -108dBc/Hz</td> </tr> <tr> <td>20kHz</td> <td>< -110dBc/Hz</td> <td>< -108dBc/Hz</td> </tr> <tr> <td>100kHz</td> <td>< -114dBc/Hz</td> <td>< -110dBc/Hz</td> </tr> </tbody> </table>		Offset	f $\leq 2.6\text{GHz}$	f > 2.6GHz	1kHz	< -100dBc/Hz	< -95dBc/Hz	10kHz	< -110dBc/Hz	< -108dBc/Hz	20kHz	< -110dBc/Hz	< -108dBc/Hz	100kHz	< -114dBc/Hz	< -110dBc/Hz
Offset	f $\leq 2.6\text{GHz}$	f > 2.6GHz															
1kHz	< -100dBc/Hz	< -95dBc/Hz															
10kHz	< -110dBc/Hz	< -108dBc/Hz															
20kHz	< -110dBc/Hz	< -108dBc/Hz															
100kHz	< -114dBc/Hz	< -110dBc/Hz															

● Frequency span	Linear span	Range Accuracy	200Hz to 8GHz, Zero span $\pm 3\%$ (Span > 2MHz), $\pm 5\%$ (Span \leq 2MHz)
	Logarithmic span	Range Accuracy	1kHz to 1GHz (1, 2, or 3 decades can be selected) $\pm (10\% + \text{Stop frequency} \times 0.1\%)$
● Resolution bandwidth (-3dB)	Range		10Hz to 3MHz, 1, 3, 10 sequence
	Accuracy		$\pm 50\%$ (Resolution bandwidth 10 to 100Hz, Digital IF) $\pm 15\%$ (Resolution bandwidth 100Hz to 1MHz) $\pm 25\%$ (Resolution bandwidth 3MHz, 30Hz)
	Selectivity		Note: 30Hz at 25°C $\pm 10^\circ\text{C}$ < 15:1 (100Hz to 3MHz) < 20:1 (30Hz) 5:1 (10 to 100Hz, Digital IF) Nominal
	Bandwidth (6dB)		200Hz, 9kHz, 120kHz (based on the CISPR specification)
● Video bandwidth	Range		1Hz to 3MHz, 1, 3, 10 sequence

(2) Amplitude Range

● Measurement range		+ 30dBm to Average indicated noise level
● Maximum safe input		$\pm 30\text{dBm}$ (1W)
Average continuous power (Input ATT $\geq 10\text{dB}$)		0 [V]
DC input		
● Display range		10 \times 10 div
Logarithmic		10, 5, 2, 1, 0.5, 0.2, 0.1 dB/div
Linear		(10% of the reference level)/div
QP logarithm		40dB (5dB/div)
● Reference level range		-140dBm to + 60dBm (0.1dB increments)
Logarithmic		2.2 μV to 223V (approx. 1% step of the full scale)
Linear		
● Input attenuator range		0 to 70dB (10dB step)

(3) Dynamic Range

<p>● Maximum dynamic range 1dB gain compression level to noise level</p> <p>Signal to Distortion</p> <p>Harmonic</p> <p>100MHz to 3.6GHz</p> <p>10MHz to 3.6GHz</p> <p>> 3.5GHz</p> <p>Third-Order intermodulation</p> <p>> 200MHz</p> <p>> 10MHz</p>	<p>200MHz to 3.6GHz : 135dB - 1.55 × f(GHz)dB</p> <p>10MHz to 3.6GHz : 130dB - 1.55 × f(GHz)dB</p> <p>87dB</p> <p>82.5dB</p> <p>112dB</p> <p>93dB</p> <p>90dB</p>
<p>● Average display noise level (Resolution bandwidth 10Hz, Digital IF, Input attenuator 0dB, Average 20 times)</p> <p>Frequency range</p> <p>1kHz</p> <p>10kHz</p> <p>100kHz</p> <p>1MHz</p> <p>10MHz to 3.6GHz</p> <p>3.5GHz to 8GHz</p>	<p>-100dBm</p> <p>-110dBm</p> <p>-111dBm</p> <p>-135dBm</p> <p>-{140 - 1.55 × f (GHz)}dBm</p> <p>-{145 - 1.55 × f (GHz)}dBm (Low noise mode)</p> <p>-135dBm</p>
<p>● 1dB gain compression</p> <p>> 200MHz</p> <p>> 10MHz</p>	<p>-5dBm (Mixer input level)</p> <p>-10dBm (Mixer input level)</p>
<p>● Spurious response</p> <p>Second harmonic distortion</p> <p>Frequency range</p> <p>100MHz to 3.6GHz</p> <p>10MHz to 3.6GHz</p> <p>> 3.5GHz</p> <p>Third-Order intermodulation distortion</p> <p>Frequency range</p> <p>200MHz to 3.6GHz</p> <p>10MHz to 3.6GHz</p> <p>> 3.5GHz</p> <p>Image/Multiple/Out-of-Band response</p> <p>10MHz to 8GHz</p>	<p>Mixer level</p> <p>-30dBm < -70dBc</p> <p>-30dBm < -60dBc</p> <p>-10dBm < -100dBc</p> <p>Mixer level</p> <p>-30dBm < -70dBc</p> <p>-30dBm < -60dBc</p> <p>-30dBm < -75dBc</p> <p>< -70dBc</p>

Residual response (No input signal, Input ATT 0dB, 50Ω terminate) 1MHz to 3.6GHz 300kHz to 8GHz	< -100dBm < -90dBm
---	-----------------------

(4) Amplitude Accuracy

<ul style="list-style-type: none"> ● Frequency response Flatness within the band (Input ATT 10dB) 100Hz to 3.6GHz : ± 1.5dB 50MHz to 2.6GHz : ± 1.0dB 3.5GHz to 7.5GHz : ± 1.5dB 7.4GHz to 8GHz : ± 1.5dB Additional error due to band switching : ± 0.5dB Calibration signal as the reference (Input ATT 10dB) : ± 3dB (100Hz to 8GHz) 	
<ul style="list-style-type: none"> ● Calibration signal accuracy : -10dBm ± 0.3dB 	
<ul style="list-style-type: none"> ● IF gain error (After self- calibration) 0dBm to -50dBm : ± 0.5dB 0dBm to -80dBm : ± 0.7dB ● Scale indication accuracy (After self calibration) Logarithmic : ± 0.2dB/1dB : ± 1dB/10dB : ± 1.5dB/90dB Linear : ± 5% of reference level QP mode logarithmic : ± 1.0dB/30dB, ± 2dB/40dB : ± 1.0dB/40dB at 25°C ± 10°C 	
<ul style="list-style-type: none"> ● Input attenuator switching error (10dB as the reference; at 20 to 70 dB) Frequency range 0 to 8 GHz : ± 1.1dB/10dB step, Maximum 2.0dB 	
<ul style="list-style-type: none"> ● Resolution bandwidth switching error (Resolution bandwidth: 300kHz reference; after self-calibration) 	100Hz to 3MHz : ± 0.3dB 30Hz : ± 1dB 10Hz to 100Hz (Digital IF) : ± 1.5dB

<ul style="list-style-type: none"> ● Pulse quantization error (In pulse measurement mode, PRF > 700/Sweep time) Peak to peak <li style="padding-left: 20px;">Logarithmic <li style="padding-left: 20px;">Linear 	<p>1.2dB (Resolution bandwidth ≤ 1MHz) 3dB (Resolution bandwidth = 3MHz) 4% of the reference level (Resolution bandwidth ≤ 1MHz) 12% of the reference level (Resolution bandwidth = 3MHz)</p>
---	---

(5) Sweep

<ul style="list-style-type: none"> ● Sweep time <li style="padding-left: 20px;">Zero span <li style="padding-left: 20px;">Span ≥ 200Hz <li style="padding-left: 20px;">Accuracy 	<p>50μs to 1000s, manual sweep 20ms to 1000s, manual sweep ± 3%</p>
<ul style="list-style-type: none"> ● Trigger 	<p>Free run, Line, Single, Video, TV-H, TV-V, External</p>

(6) Demodulation

<ul style="list-style-type: none"> ● Spectrum demodulation <li style="padding-left: 20px;">Modulation type <li style="padding-left: 20px;">Audio output <li style="padding-left: 20px;">Demodulation duration 	<p>AM, FM Internal speaker, earphone jack, sound volume adjustable 100ms to 1000s</p>
---	---

(7) Input/Output

<ul style="list-style-type: none"> ● RF input <li style="padding-left: 20px;">Connector <li style="padding-left: 20px;">Impedance <li style="padding-left: 20px;">VSWR <li style="padding-left: 20px;">(Frequency setting input ATT ≥ 10 dB) <li style="padding-left: 20px;">LO radiation (average) 	<p>N-type female 50Ω (nominal) < 1.5 : 1 (≤ 3.6GHz) (nominal) < 2.0 : 1 (> 3.6GHz) (nominal) < - 80dBm typical (Frequency setting 0 to 8 GHz , input attenuation 10dB)</p>
---	--

<ul style="list-style-type: none"> ● Calibration signal output <ul style="list-style-type: none"> Connector Frequency Impedance Amplitude 	BNC female, Front panel 25MHz × (1 ± Frequency reference accuracy) 50Ω (nominal) - 10dBm ± 0.3dB									
<ul style="list-style-type: none"> ● 10MHz frequency reference input/output <ul style="list-style-type: none"> Connector Impedance Frequency range Amplitude Input range 	BNC female, Rear panel 50Ω (nominal) 10MHz × Frequency reference accuracy 0dBm ± 3dB -5dBm to +5dBm									
<ul style="list-style-type: none"> ● 21.4MHz IF output <ul style="list-style-type: none"> Connector Impedance Amplitude 3dB bandwidth 	BNC female, Rear panel 50Ω (nominal) 0dBm (Typ) in full scale = Resolution bandwidth									
<ul style="list-style-type: none"> ● 421MHz IF output <ul style="list-style-type: none"> Connector Impedance Gain, Noise factor, 3dB bandwidth Frequency range 1MHz to 3.6GHz 3.5GHz to 8GHz 	BNC female, Rear panel 50Ω (nominal) <table border="1" style="margin-left: auto; margin-right: auto;"> <thead> <tr> <th>3dB bandwidth (nominal)</th> <th>Noise factor (nominal)</th> <th>Gain (nominal)</th> </tr> </thead> <tbody> <tr> <td>> 15MHz</td> <td>17dB</td> <td>+ 6dB</td> </tr> <tr> <td>> 30MHz</td> <td>24dB</td> <td>-9dB</td> </tr> </tbody> </table>	3dB bandwidth (nominal)	Noise factor (nominal)	Gain (nominal)	> 15MHz	17dB	+ 6dB	> 30MHz	24dB	-9dB
3dB bandwidth (nominal)	Noise factor (nominal)	Gain (nominal)								
> 15MHz	17dB	+ 6dB								
> 30MHz	24dB	-9dB								
<ul style="list-style-type: none"> ● Video output <ul style="list-style-type: none"> Connector Impedance (AC connection) Amplitude (75Ω terminate) 	BNC female, Rear panel 75Ω (nominal) Approx. 1V _{p-p} (Composite video signal)									
<ul style="list-style-type: none"> ● X axis, 2V/n GHz output <ul style="list-style-type: none"> Connector Impedance X axis output 2V/n GHz 	BNC female, Rear panel 1kΩ (nominal), DC connection approx. -5V to +5V approx. 2V per 1GHz									
<ul style="list-style-type: none"> ● Y axis output <ul style="list-style-type: none"> Connector Impedance Amplitude 	BNC female, Rear panel 220Ω (nominal) approx. 2V in full scale									

<ul style="list-style-type: none"> ● Z axis output Connector Amplitude During sweep Retrace interval 	<ul style="list-style-type: none"> BNC female, Rear panel TTL level High level Low level
<ul style="list-style-type: none"> ● External trigger input Connector Impedance Trigger level 	<ul style="list-style-type: none"> BNC female, Rear panel 10kΩ (nominal), DC connection TTL level
<ul style="list-style-type: none"> ● Gate input Connector Impedance Sweep stop Sweep 	<ul style="list-style-type: none"> BNC female, Rear panel 10 kΩ (nominal) During low mode at TTL level During high mode at TTL level
<ul style="list-style-type: none"> ● Probe power Voltage Current 	<ul style="list-style-type: none"> 4-pin connector, Front panel +15V, -15V Max.150mA each
<ul style="list-style-type: none"> ● Voice output (Demodulation audio) Connector Power output 	<ul style="list-style-type: none"> Small-size monophonic jack, Front panel Maximum 0.2W, 8Ω (nominal)
<ul style="list-style-type: none"> ● GPIB Plotters 	<ul style="list-style-type: none"> IEEE-488 bus connector R9833, HP7470A, HP7475A, HP7440A, HP7550A

(8) Delay Sweep and Gated Sweep Functions

<p>● DELAY SWEEP</p> <p>Trigger Signal Source</p> <p>DELAY TIME</p> <p>DELAY SWEEP TIME</p>	<p>External trigger input (Enabled to switching the TTL level and rise/fall slope)</p> <p>VIDEO trigger (Enabled to switching the rise/fall slope)</p> <p>TV-V trigger (Enabled to switching the rise/fall slope)</p> <p>200ns to 1.5s Resolution 100ns</p> <p>50μs to 1000s</p>
<p>● GATED SWEEP</p> <p>Trigger Signal Source</p> <p>GATE position</p> <p>GATE width</p>	<p>< F domain analysis ></p> <p>Output trigger input (Enabled to switching the TTL level and rise/fall slope)</p> <p>Gate input (TTL level and rise slope)</p> <p>IF DET trigger (Enabled to switching the rise/fall slope, slew/low-pass filter)</p> <p>Trigger level variable on IF DET monitor</p> <p>The following ranges can be used.</p> <p>Span : 7MHz or less</p> <p>Input pulse width : 100μs or more</p> <p>< TIME domain analysis ></p> <p>External trigger input (Enabled to switching the TTL level and rise/fall slope)</p> <p>Gate input (TTL level and rise slope)</p> <p>IF DET trigger (Enabled to switching the rise/fall slope, slew/low-pass filter)</p> <p>Trigger level variable on IF DET monitor</p> <p>The following ranges can be used.</p> <p>Input pulse width : 100μs or more</p> <p>300ns to 100ms Resolution 100ns</p> <p>1μs to 1.5s Resolution 100ns</p>

(9) General Specifications

● Temperature and humidity During operation When stored Relative Humidity	0°C to 50°C -20°C to 60°C 85% or below
● Power source During 100VAC operation Voltage Power consumption Frequency During 220VAC operation Voltage Power consumption Frequency	90V to 132V 400VA at maximum 48Hz to 440Hz 198V to 250V 400VA at maximum 48Hz to 66Hz
● Weight R3265A R3365A	22kg (nominal) (Excluding optional blocks, front cover, and accessories) 23kg (nominal) (Excluding optional blocks, front cover, and accessories)
● Dimensions	Approx. 177mm (Height) × 353mm (Width) × 450mm (Depth) (Excluding the handle, legs and front cover)

(10) Tracking Generator Specifications (R3365A only)

● Frequency range	100kHz to 3.6 GHz
● Output level range	-3dBm to -30dBm
● Output level flatness (25MHz, -10dBm output)	± 3dB (100kHz to 3.6GHz)
● Output level accuracy	± 0.5dB (25MHz, -10dBm, 25°C ± 10°C)
● Burn-in accuracy	± 0.5dB/1dB (25MHz, 25°C ± 10°C)
● Output spurious accuracy : Harmonics : Non harmonics	-15dBc (at -3dBm output) -25dBc (at -3dBm output)
● TG leakage	-110dBm (100kHz to 3GHz) -105dBm (3GHz to 3.6GHz)
● Power Sweep range Setting resolution	30dB 0.1dB

10.2 R3271A/3371A Specifications

(1) Frequency Characteristics

● Frequency range	100Hz to 26.5GHz 18GHz to 60GHz (Using an external mixer; Tuning available up to 325GHz) Frequency band 100Hz to 3.6GHz 3.5GHz to 7.5GHz 7.4GHz to 15.4GHz 15.2GHz to 23.3GHz 23GHz to 26.5GHz	Harmonic mode (n) 1 1 2 3 4															
● Frequency read accuracy (Start, Stop, Center frequency, Marker frequency)	$\pm (\text{Frequency read} \times \text{Frequency reference accuracy} + \text{Span} \times \text{Span accuracy} + 0.15 \times \text{Resolution bandwidth} + 10\text{Hz})$ Span accuracy (Span > 2MHz) $\pm 3\%$ (Span \leq 2MHz) $\pm 5\%$																
● Marker frequency counter Resolution Accuracy (S/N \geq 25dB) Delta counter accuracy	1Hz to 1kHz $\pm (\text{Marker frequency} \times \text{Frequency reference accuracy} + 5\text{Hz} \times N + 1\text{LSD})$ $\pm (\text{Delta frequency} \times \text{Frequency reference accuracy} + 10\text{Hz} \times N + 2\text{LSD})$																
● Frequency reference accuracy	$\pm 2 \times 10^{-8}$ /Day $\pm 1 \times 10^{-7}$ /Year																
● Frequency stability Residual FM (Zero span) Drift (After 1 hour warm-up)	$< 3\text{Hz} \times N_{p.p} / 0.1 \text{ sec}$ $50\text{kHz} < \text{Span} \leq 2\text{MHz}; < 2.5\text{kHz} \times \text{Sweep speed (min)} \times N$ $\text{Span} \leq 50\text{kHz}; < 60\text{Hz} \times \text{Sweep speed (min)} \times N$																
● Signal purity noise side band	<table border="1"> <thead> <tr> <th>Offset</th> <th>f \leq 2.6GHz</th> <th>f > 2.6GHz</th> </tr> </thead> <tbody> <tr> <td>1kHz</td> <td>< -100dBc/Hz</td> <td>< (-95 + 20logN)dBc/Hz</td> </tr> <tr> <td>10kHz</td> <td>< -110dBc/Hz</td> <td>< (-108 + 20logN)dBc/Hz</td> </tr> <tr> <td>20kHz</td> <td>< -110dBc/Hz</td> <td>< (-108 + 20logN)dBc/Hz</td> </tr> <tr> <td>100kHz</td> <td>< -114dBc/Hz</td> <td>< (-110 + 20logN)dBc/Hz</td> </tr> </tbody> </table>		Offset	f \leq 2.6GHz	f > 2.6GHz	1kHz	< -100dBc/Hz	< (-95 + 20logN)dBc/Hz	10kHz	< -110dBc/Hz	< (-108 + 20logN)dBc/Hz	20kHz	< -110dBc/Hz	< (-108 + 20logN)dBc/Hz	100kHz	< -114dBc/Hz	< (-110 + 20logN)dBc/Hz
Offset	f \leq 2.6GHz	f > 2.6GHz															
1kHz	< -100dBc/Hz	< (-95 + 20logN)dBc/Hz															
10kHz	< -110dBc/Hz	< (-108 + 20logN)dBc/Hz															
20kHz	< -110dBc/Hz	< (-108 + 20logN)dBc/Hz															
100kHz	< -114dBc/Hz	< (-110 + 20logN)dBc/Hz															

(2) Amplitude Bandwidth

<ul style="list-style-type: none"> ● Frequency span Linear span Range Accuracy Logarithmic span Range Accuracy 	<p>200Hz to 20.5GHz, Zero span $\pm 3\%$ (Span > 2MHz) $\pm 5\%$ (Span \leq 2MHz)</p> <p>1kHz to 1GHz (1, 2, or 3 decades can be selected) $\pm (10\% + \text{Stop frequency} \times 0.1\%)$</p>
<ul style="list-style-type: none"> ● Resolution bandwidth (-3dB) Range Accuracy Selectivity Bandwidth (6dB) 	<p>10Hz to 3MHz; 1, 3, 10 sequence $\pm 50\%$ (Resolution bandwidth 10 to 100Hz, Digital IF) $\pm 15\%$ (Resolution bandwidth 100Hz to 1MHz) $\pm 25\%$ (Resolution bandwidth 3MHz, 30Hz) Note: 30Hz at 25°C \pm 10°C < 15:1 (100Hz to 3MHz) < 20:1 (30Hz) 5:1 (10 to 100Hz, Digital IF) Nominal 200Hz, 9kHz, 120kHz (based on the CISPR specification)</p>
<ul style="list-style-type: none"> ● Video bandwidth Range 	<p>1Hz to 3MHz; 1, 3, 10 sequence</p>

<ul style="list-style-type: none"> ● Measurement range 	<p>+ 30dBm to Average indication noise level</p>
<ul style="list-style-type: none"> ● Maximum safe input Average continuous power (Input ATT \geq 10dB) DC input 	<p>+ 30dBm (1W) 0 [V]</p>
<ul style="list-style-type: none"> ● Display range Logarithmic Linear QP logarithmic 	<p>10 \times 10 div 10, 5, 2, 1, 0.5, 0.2, 0.1 dB/div (10% of the reference level) /div 40dB (5dB/div)</p>
<ul style="list-style-type: none"> ● Reference level range Logarithmic Linear 	<p>-140dBm to +60dBm (0.1dB step) 2.2μV to 223V (approx. 1% step of the full scale)</p>
<ul style="list-style-type: none"> ● Input attenuator range 	<p>0 to 70 dB (10dB step)</p>

(3) Dynamic Range

<ul style="list-style-type: none"> ● Maximum dynamic range 1dB gain compression level to noise level Signal to Distortion Harmonic 10MHz to 3.6GHz > 3.5GHz Third-Order intermodulation > 10MHz 	<p>10MHz to 3.6GHz: $130\text{dB} - 1.55 \times f(\text{GHz}) \text{ dB}$</p> <p>85dB 110dB 90dB</p>
<ul style="list-style-type: none"> ● Average display noise level (Resolution bandwidth 10Hz, Digital IF, Input attenuator 0dB, Average 20 times) Frequency range 1kHz 10kHz 100kHz 1MHz to 3.6GHz 3.5GHz to 7.5GHz 7.5GHz to 15.4GHz 15.2GHz to 23.3GHz 23GHz to 26.5GHz 	<p>-100dBm -110dBm -111dBm $-\{135 - 1.55 \times f(\text{GHz})\}\text{dBm}$ -130dBm -123dBm -116dBm -110dBm</p>
<ul style="list-style-type: none"> ● 1dB gain compression > 10MHz 	<p>-5dBm (Mixer input level)</p>
<ul style="list-style-type: none"> ● Spurious response Second harmonic distortion Frequency range 10MHz to 3.6GHz > 3.5GHz Third-Order intermodulation distortion Frequency range 10MHz to 3.6GHz > 3.5GHz Image/Multiple/Out-of-Band response 10MHz to 18GHz 10MHz to 23GHz 10MHz to 26.5Hz 	<p>Mixer level -30dBm < -70dBc -10dBm < -100dBc</p> <p>Mixer level -30dBm < -70dBc -30dBm < -75dBc</p> <p>< -70dBc < -60dBc < -50dBc</p>

Residual response (No input signal, Input ATT 0dB, 50 Ω terminate) 1MHz to 3.6GHz 300kHz to 26.5GHz	< -100dBm < -90dBm
--	-----------------------

(4) Amplitude Accuracy

<ul style="list-style-type: none"> ● Frequency response Flatness within the band (Input ATT 10dB) 100Hz to 3.6GHz ± 1.5dB 50MHz to 2.6GHz ± 1.0dB 3.5GHz to 7.5GHz ± 1.5dB 7.4GHz to 15.4GHz ± 3.5dB 15.4GHz to 23.3GHz ± 4.0dB 23GHz to 26.5GHz ± 4.0dB Additional error due to band switching ± 0.5dB When the calibration signal is used as the reference (Input ATT 10dB) ± 5dB (100Hz to 26.5GHz) 	
<ul style="list-style-type: none"> ● Calibration signal accuracy 	-10dBm ± 0.3 dB
<ul style="list-style-type: none"> ● IF gain error (After self- calibration) 0dBm to -50dBm ± 0.5dB 0dBm to -80dBm ± 0.7dB ● Scale indication accuracy (after self-calibration) Logarithmic ± 0.2dB/1dB ± 1dB/10dB ± 1.5dB/90dB Linear $\pm 5\%$ of the reference level QP mode logarithmic ± 1.0dB/30dB, ± 2dB/40dB ± 1.0dB/40dB at 25°C ± 10°C 	
<ul style="list-style-type: none"> ● Input attenuator switching error (Based on 10dB; in the range of 20 to 70 dB) Frequency range 0 to 12.4 GHz ± 1.1dB/10dB step; Maximum 2.0dB 12.4 to 18 GHz ± 1.3dB/10dB step; Maximum 2.5dB 18 to 26.5 GHz ± 1.8dB/10dB step; Maximum 3.5dB 	
<ul style="list-style-type: none"> ● Resolution bandwidth switching error (Resolution bandwidth: 300kHz reference; after self-calibration) 	100Hz to 3MHz : ± 0.3 dB 30Hz, 10Hz : ± 1 dB 10 to 100 Hz (Digital IF) : ± 1.5 dB

<ul style="list-style-type: none"> ● Pulse quantization error (In pulse measurement mode: PRF > 700/Sweep time) <li style="padding-left: 20px;">Peak to peak <li style="padding-left: 20px;">Logarithmic <li style="padding-left: 20px;">Linear 	<ul style="list-style-type: none"> 1.2dB (Resolution bandwidth ≤ 1MHz) 3dB (Resolution bandwidth = 3MHz) 4% of the reference level (Resolution bandwidth ≤ 1MHz) 12% of the reference level (Resolution bandwidth = 3MHz)
--	---

(5) Sweep

<ul style="list-style-type: none"> ● Sweep time <li style="padding-left: 20px;">Zero span <li style="padding-left: 20px;">Span ≥ 200Hz <li style="padding-left: 20px;">Accuracy 	<ul style="list-style-type: none"> 50μs to 1000s, Manual sweep 20ms to 1000s, Manual sweep ± 3%
<ul style="list-style-type: none"> ● Trigger 	<ul style="list-style-type: none"> Free run, Line, Single, Video, TV-H, TV-V, External

(6) Demodulation

<ul style="list-style-type: none"> ● Spectrum demodulation <li style="padding-left: 20px;">Modulation type <li style="padding-left: 20px;">Audio output <li style="padding-left: 20px;">Demodulation duration 	<ul style="list-style-type: none"> AM, FM Internal speaker, earphone jack, sound volume adjustable 100ms to 1000s
---	--

(7) Input/Output

<ul style="list-style-type: none"> ● RF input <li style="padding-left: 20px;">Connector <li style="padding-left: 20px;">Impedance <li style="padding-left: 20px;">VSWR <li style="padding-left: 20px;">(Input ATT ≥ 10dB, frequency setting) <li style="padding-left: 20px;">LO radiation (average) 	<ul style="list-style-type: none"> N-type, female (can be converted into SMA type) 50Ω (nominal) < 1.5:1 (≤ 3.6GHz) (nominal) < 2.5:1 (> 3.6GHz) (nominal) < -80dBm Typ (Frequency setting 0 to 26.5 GHz, input attenuation 10dB)
<ul style="list-style-type: none"> ● First LO output <li style="padding-left: 20px;">Connector <li style="padding-left: 20px;">Impedance <li style="padding-left: 20px;">Frequency range <li style="padding-left: 20px;">Amplitude 	<ul style="list-style-type: none"> SMA, female, Front panel 50Ω (nominal) 3.921 to 7.921 GHz + 5dBm or above

<ul style="list-style-type: none"> ● Calibration signal output <ul style="list-style-type: none"> Connector Frequency Impedance Amplitude 	BNC female, Front panel 25MHz × (1 ± Frequency reference accuracy) 50Ω (nominal) - 10dBm ± 0.3dB																		
<ul style="list-style-type: none"> ● 10MHz frequency reference input/output <ul style="list-style-type: none"> Connector Impedance Frequency range Amplitude Input range 	BNC female, Rear panel 50Ω (nominal) 10MHz × Frequency reference accuracy 0dBm ± 3dB -5dBm to +5dBm																		
<ul style="list-style-type: none"> ● 21.4MHz IF output <ul style="list-style-type: none"> Connector Impedance Amplitude 3dB bandwidth 	BNC female, Rear panel 50Ω (nominal) 0dBm (Typ) in full scale = Resolution bandwidth																		
<ul style="list-style-type: none"> ● 421MHz IF output <ul style="list-style-type: none"> Connector Impedance Gain, Noise factor, 3dB bandwidth Frequency range 1MHz to 3.6GHz 3.5GHz to 8GHz 7.4GHz to 15.4GHz 15.2GHz to 23.3GHz 23GHz to 26.5GHz 	BNC female, Rear panel 50Ω (nominal) <table border="1" style="margin-left: auto; margin-right: auto;"> <thead> <tr> <th>3dB bandwidth (nominal)</th> <th>Noise factor (nominal)</th> <th>Gain (nominal)</th> </tr> </thead> <tbody> <tr> <td>> 15MHz</td> <td>24dB</td> <td>-5dB</td> </tr> <tr> <td>> 30MHz</td> <td>24dB</td> <td>-4dB</td> </tr> <tr> <td>> 35MHz</td> <td>30dB</td> <td>-10dB</td> </tr> <tr> <td>> 40MHz</td> <td>38dB</td> <td>-18dB</td> </tr> <tr> <td>> 50MHz</td> <td>44dB</td> <td>-24dB</td> </tr> </tbody> </table>	3dB bandwidth (nominal)	Noise factor (nominal)	Gain (nominal)	> 15MHz	24dB	-5dB	> 30MHz	24dB	-4dB	> 35MHz	30dB	-10dB	> 40MHz	38dB	-18dB	> 50MHz	44dB	-24dB
3dB bandwidth (nominal)	Noise factor (nominal)	Gain (nominal)																	
> 15MHz	24dB	-5dB																	
> 30MHz	24dB	-4dB																	
> 35MHz	30dB	-10dB																	
> 40MHz	38dB	-18dB																	
> 50MHz	44dB	-24dB																	
<ul style="list-style-type: none"> ● Video output <ul style="list-style-type: none"> Connector Impedance (AC connection) Amplitude (75Ω terminate) 	BNC female, Rear panel 75Ω (nominal) Approx. 1V _{p,p} (Composite video signal)																		
<ul style="list-style-type: none"> ● X axis, 2V/n GHz output <ul style="list-style-type: none"> Connector Impedance X axis output 2V/n GHz 	BNC female, Rear panel 1kΩ (nominal), DC connection approx. -5V to +5V approx. 2V per 1GHz																		
<ul style="list-style-type: none"> ● Y axis output <ul style="list-style-type: none"> Connector Impedance Amplitude 	BNC female, Rear panel 220Ω (nominal) approx. 2V in full scale																		

<ul style="list-style-type: none"> ● Z axis output <ul style="list-style-type: none"> Connector Amplitude During sweep Retrace interval 	<ul style="list-style-type: none"> BNC female, Rear panel TTL level High level Low level
<ul style="list-style-type: none"> ● External trigger input <ul style="list-style-type: none"> Connector Impedance Trigger level 	<ul style="list-style-type: none"> BNC female, Rear panel 10kΩ (nominal), DC connection Trigger at the TTL level
<ul style="list-style-type: none"> ● Gate input <ul style="list-style-type: none"> Connector Impedance Sweep stop Sweep 	<ul style="list-style-type: none"> BNC female, Rear panel 10kΩ (nominal) During low mode at TTL level During high mode at TTL level
<ul style="list-style-type: none"> ● Probe power <ul style="list-style-type: none"> Voltage Current 	<ul style="list-style-type: none"> 4-pin connector, Front panel + 15V, -15V Max. 150mA each
<ul style="list-style-type: none"> ● Voice output (Demodulation audio) <ul style="list-style-type: none"> Connector Power output 	<ul style="list-style-type: none"> Small-size monophonic jack, Front panel Maximum 0.2W, 8Ω (nominal)
<ul style="list-style-type: none"> ● GPIB <ul style="list-style-type: none"> Plotters 	<ul style="list-style-type: none"> IEEE-488, Bus connector R9833, HP7470A, HP7475A, HP7440A, HP7550A

(8) Delay Sweep and Gated Sweep Functions

<p>● DELAY SWEEP</p> <p>Trigger Signal Source</p> <p>DELAY TIME</p> <p>DELAY SWEEP TIME</p>	<p>External trigger input (Enabled to switching the TTL level and rise/fall slope) VIDEO trigger (Enabled to switching the rise/fall slope) TV-V trigger (Enabled to switching the rise/fall slope)</p> <p>200ns to 1.5s Resolution 100ns</p> <p>50μs to 1000s</p>
<p>● GATED SWEEP</p> <p>Trigger Signal Source</p> <p>GATE position</p> <p>GATE width</p>	<p>< F domain analysis > Output trigger input (Enabled to switching the TTL level and rise/fall slope) Gate input (TTL level and rise slope) IF DET trigger (Enabled to switching the rise/fall slope, slew/low-pass filter) Trigger level variable on IF DET monitor The following ranges can be used. Span : 7MHz or less Input pulse width : 100μs or more</p> <p>< TIME domain analysis > External trigger input (Enabled to switching the TTL level and rise/fall slope) Gate input (TTL level and rise slope) IF DET trigger (Enabled to switching the rise/fall slope, slew/low-pass filter) Trigger level variable on IF DET monitor The following ranges can be used. Input pulse width : 100μs or more</p> <p>300ns to 100ms Resolution 100ns</p> <p>1μs to 1.5s Resolution 100ns</p>

(9) General Specifications

● Temperature and humidity During operation When stored Relative Humidity	0°C to 50°C -20°C to 60°C 85% or below
● Power source During 100VAC operation Voltage Power consumption Frequency During 220VAC operation Voltage Power consumption Frequency	90V to 132V 400VA at maximum 48Hz to 440Hz 198V to 250V 400VA at maximum 48Hz to 66Hz
● Weight R3271A R3371A	22kg (nominal) (Excluding optional blocks, front cover, and accessories) 23kg (nominal) (Excluding optional blocks, front cover, and accessories)
● Dimensions	Approx. 177mm (Height) × 353mm (Width) × 450mm (Depth) (Excluding the handle, legs and front cover)

(10) Tracking Generator Specifications (R3371A only)

● Frequency range	100kHz to 3.6 GHz
● Output level range	-3dBm to -30dBm
● Output level flatness (25MHz, -10dBm output)	± 3dB (100kHz to 3.6GHz)
● Output level accuracy	± 0.5dB (25MHz, -10dBm, 25°C ± 10°C)
● Burn-in accuracy	± 0.5dB/1dB (25MHz, 25°C ± 10°C)
● Output spurious accuracy : Harmonics : Non harmonics	-15dBc (at -3dBm output) -25dBc (at -3dBm output)
● TG leakage	-110dBm (100kHz to 3GHz) -100dBm (3GHz to 3.6GHz)
● Power Sweep range Setting resolution	30dB 0.1dB

(2) Amplitude Range

● Measurement range	+ 30dBm to Average indicated noise level
● Maximum safe input Average continuous power (Input ATT \geq 10dB) DC input	\pm 30dBm (1W) 0 [V]
● Display range Logarithmic Linear QP logarithm	10 \times 10 div 10, 5, 2, 1, 0.5, 0.2, 0.1 dB/div (10% of the reference level)/div 40dB (5dB/div)
● Reference level range Logarithmic Linear	-140dBm to +60dBm (0.1dB increments) 2.2 μ V to 223V (approx. 1% step of the full scale)
● Input attenuator range	0 to 70dB (10dB step)

(3) Dynamic Range

<p>● Maximum dynamic range 1dB gain compression level to noise level</p> <p>Signal to Distortion</p> <p>R3265AP Harmonic</p> <p>10MHz to 600MHz 500MHz ≤ f < 800MHz 800MHz ≤ f < 1.0GHz 1.0GHz to 3.6GHz > 3.5GHz</p> <p>Third-Order intermodulation 10MHz to 250MHz > 250MHz</p> <p>R3271AP Harmonic</p> <p>10MHz to 600MHz 500MHz ≤ f < 800MHz 800MHz ≤ f < 1.0GHz 1.0GHz to 3.6GHz > 3.5GHz</p> <p>Third-Order intermodulation 10MHz to 250MHz > 250MHz</p>	<p>200MHz to 3.6GHz : 129dB - 1.55 × f(GHz)dB 10MHz to 3.6GHz : 126dB - 1.55 × f(GHz)dB</p> <p>83dB 96dB 101dB 104dB 112dB</p> <p>91dB 90dB</p> <p>83dB 96dB 101dB 104dB 110dB</p> <p>91dB 90dB</p>
<p>● Average display noise level (Resolution bandwidth 10Hz, Digital IF, input attenuator 0dB, Average 20 times)</p> <p>Frequency range</p> <p>R3265AP</p> <p>1kHz 10kHz 100kHz 1MHz to 3.6GHz 3.5GHz to 8GHz</p> <p>R3271AP</p> <p>1kHz 10kHz 100kHz 1MHz to 3.6GHz 3.5GHz to 7.5GHz 7.5GHz to 15.4GHz 15.2GHz to 23.3GHz 23GHz to 26.5GHz</p>	<p>-100dBm -110dBm -111dBm -{134 - 1.55 × f (GHz)}dBm -135dBm</p> <p>-100dBm -110dBm -111dBm -{134 - 1.55 × f (GHz)}dBm -130dBm -123dBm -116dBm -110dBm</p>
<p>● 1dB gain compression</p> <p>> 200MHz > 10MHz</p>	<p>-5dBm (Mixer input level) -10dBm (Mixer input level)</p>

<p>● Spurious response</p> <p>Second harmonic distortion</p> <p>Frequency range (Fundamental)</p> <p>10MHz to 300MHz</p> <p>250MHz \leq f < 400MHz</p> <p>400MHz \leq f < 500MHz</p> <p>500MHz to 1.8GHz</p> <p>> 1.75GHz</p> <p>Third-Order intermodulation distortion</p> <p>Frequency range</p> <p>10MHz to 200MHz</p> <p>200MHz to 3.6GHz</p> <p>> 3.5GHz</p> <p>Image/Multiple/Out-of-Band response</p> <p>R3265AP</p> <p>10MHz to 8GHz</p> <p>R3271AP</p> <p>10MHz to 18GHz</p> <p>10MHz to 23GHz</p> <p>10MHz to 26.5GHz</p>	<p>Mixer level</p> <p>-30dBm < -63dBc</p> <p>-10dBm < -70dBc</p> <p>-10dBm < -80dBc</p> <p>-10dBm < -90dBc</p> <p>-10dBm < -100dBc</p> <p>Mixer level</p> <p>-30dBm < -65dBc</p> <p>-30dBm < -70dBc</p> <p>-30dBm < -75dBc</p> <p>< -70dBc</p> <p>< -70dBc</p> <p>< -60dBc</p> <p>< -50dBc</p>
<p>Residual response</p> <p>(No input signal, Input ATT 0dB, 50Ω terminate)</p> <p>R3265AP</p> <p>1MHz to 3.6GHz</p> <p>3.6GHz to 8GHz</p> <p>R3271AP</p> <p>1MHz to 3.6GHz</p> <p>300kHz to 26.5GHz</p>	<p>< -100dBm</p> <p>< -90dBm</p> <p>< -100dBm</p> <p>< -90dBm</p>

(4) Amplitude Accuracy

<p>● Frequency response Flatness within the band (Input ATT 10dB)</p> <p>R3265AP 50MHz to 600MHz 500MHz to 3.6GHz Additional error due to band switching Calibration signal as the reference (Input ATT 10dB)</p> <p>R3271AP 50MHz to 600MHz 500MHz to 3.6GHz 3.5GHz to 7.5GHz 7.4GHz to 15.4GHz 15.4GHz to 23.3GHz 23GHz to 26.5GHz Additional error due to band switching Calibration signal as the reference (Input ATT 10dB)</p>	<p>± 1.0dB ± 1.6dB ± 0.5dB ± 3dB (100Hz to 8GHz)</p> <p>± 1.0dB ± 1.6dB ± 1.5dB ± 3.5dB ± 4.0dB ± 4.0dB ± 0.5dB ± 5dB (100Hz to 26.5GHz)</p>
<p>● Calibration signal accuracy</p>	<p>-10dBm ± 0.3dB</p>
<p>● IF gain error (After self-calibration) 0dBm to -50dBm 0dBm to -80dBm</p> <p>● Scale indication accuracy (After self calibration) Logarithmic</p> <p>Linear QP mode logarithmic</p>	<p>± 0.5dB ± 0.7dB</p> <p>± 0.2dB/1dB ± 1dB/10dB ± 1.5dB/90dB ± 5% of reference level ± 1.0dB/30dB, ± 2dB/40dB ± 1.0dB/40dB at 25°C ± 10°C</p>
<p>● Input attenuator switching error (10dB as the reference; at 20 to 70 dB)</p> <p>Frequency range R3265AP 0 to 8GHz R3271AP 0 to 12.4GHz 12.4 to 18GHz 18 to 26.5GHz</p>	<p>± 1.1dB/10dB Step, Maximum 2.0dB</p> <p>± 1.1dB/10dB Step, Maximum 2.0dB ± 1.3dB/10dB Step, Maximum 2.5dB ± 1.8dB/10dB Step, Maximum 3.5dB</p>

<ul style="list-style-type: none"> ● Resolution bandwidth switching error (Resolution bandwidth: 300kHz reference; after self-calibration) 	100Hz to 3MHz : $\pm 0.3\text{dB}$ 30Hz, 10Hz : $\pm 1\text{dB}$ 10Hz to 100Hz (Digital IF) : $\pm 1.5\text{dB}$
<ul style="list-style-type: none"> ● Pulse quantization error (In pulse measurement mode, PRF > 700/Sweep time) Peak to peak Logarithmic Linear 	1.2dB (Resolution bandwidth $\leq 1\text{MHz}$) 3dB (Resolution bandwidth = 3MHz) 4% of the reference level (Resolution bandwidth $\leq 1\text{MHz}$) 12% of the reference level (Resolution bandwidth = 3MHz)

(5) Sweep

<ul style="list-style-type: none"> ● Sweep time Zero span Span $\geq 200\text{Hz}$ Accuracy 	50 μs to 1000s, manual sweep 20ms to 1000s, manual sweep $\pm 3\%$
<ul style="list-style-type: none"> ● Trigger 	Free run, Line, Single, Video, TV-H, TV-V, External

(6) Demodulation

<ul style="list-style-type: none"> ● Spectrum demodulation Modulation type Audio output Demodulation duration 	AM, FM Internal speaker, earphone jack, sound volume adjustable 100ms to 1000s
--	--

(7) Input/Output

<ul style="list-style-type: none"> ● RF input Connector Impedance VSWR (Frequency setting input ATT $\geq 10\text{ dB}$) LO radiation (average) 	N-type female (Convertible in the SMA type) 50 Ω (nominal) (Frequency setting, input ATT $\geq 10\text{dB}$) < 1.5 : 1 ($\leq 3.6\text{GHz}$) (nominal) < 2.0 : 1 ($> 3.6\text{GHz}$) (nominal) (Frequency setting 0 to 8 GHz , input ATT 10dB) < -80dBm typical
<ul style="list-style-type: none"> ● First LO output (R3271AP Only) Connector Impedance Frequency range Amplitude 	SMA female, Front panel 50 Ω (nominal) 3.921 to 7.921 GHz +5dBm or above

<ul style="list-style-type: none"> ● Calibration signal output <ul style="list-style-type: none"> Connector Frequency Impedance Amplitude 	BNC female, Front panel 25MHz × (1 ± Frequency reference accuracy) 50Ω (nominal) - 10dBm ± 0.3dB																											
<ul style="list-style-type: none"> ● 10MHz frequency reference input/output <ul style="list-style-type: none"> Connector Impedance Frequency range Amplitude Input range 	BNC female, Rear panel 50Ω (nominal) 10MHz × Frequency reference accuracy 0dBm ± 3dBm -5dBm to + 5dBm																											
<ul style="list-style-type: none"> ● 21.4MHz IF output <ul style="list-style-type: none"> Connector Impedance Amplitude 3dB bandwidth 	BNC female, Rear panel 50Ω (nominal) 0dBm (Typ) in full scale = Resolution bandwidth																											
<ul style="list-style-type: none"> ● 421MHz IF output <ul style="list-style-type: none"> Connector Impedance Gain, Noise factor, 3dB bandwidth <p style="margin-left: 40px;">R3265AP</p> <p style="margin-left: 40px;">Frequency range 1MHz to 3.6GHz 3.5GHz to 8GHz</p> <p style="margin-left: 40px;">R3271AP</p> <p style="margin-left: 40px;">Frequency range 1MHz to 3.6GHz 3.5GHz to 8GHz 7.4GHz to 15.4GHz 15.2GHz to 23.3GHz 23GHz to 26.5GHz</p>	BNC female, Rear panel 50Ω (nominal) <table border="1" style="margin-left: auto; margin-right: auto; border-collapse: collapse; text-align: center;"> <thead> <tr> <th>3dB bandwidth (nominal)</th> <th>Noise factor (nominal)</th> <th>Gain (nominal)</th> </tr> </thead> <tbody> <tr> <td>> 14MHz</td> <td>22dB</td> <td>+ 2dB</td> </tr> <tr> <td>> 30MHz</td> <td>24dB</td> <td>-9dB</td> </tr> </tbody> </table> <table border="1" style="margin-left: auto; margin-right: auto; border-collapse: collapse; text-align: center;"> <thead> <tr> <th>3dB bandwidth (nominal)</th> <th>Noise factor (nominal)</th> <th>Gain (nominal)</th> </tr> </thead> <tbody> <tr> <td>> 14MHz</td> <td>22dB</td> <td>+ 2dB</td> </tr> <tr> <td>> 30MHz</td> <td>24dB</td> <td>-4dB</td> </tr> <tr> <td>> 35MHz</td> <td>30dB</td> <td>-10dB</td> </tr> <tr> <td>> 40MHz</td> <td>38dB</td> <td>-18dB</td> </tr> <tr> <td>> 50MHz</td> <td>44dB</td> <td>-24dB</td> </tr> </tbody> </table>	3dB bandwidth (nominal)	Noise factor (nominal)	Gain (nominal)	> 14MHz	22dB	+ 2dB	> 30MHz	24dB	-9dB	3dB bandwidth (nominal)	Noise factor (nominal)	Gain (nominal)	> 14MHz	22dB	+ 2dB	> 30MHz	24dB	-4dB	> 35MHz	30dB	-10dB	> 40MHz	38dB	-18dB	> 50MHz	44dB	-24dB
3dB bandwidth (nominal)	Noise factor (nominal)	Gain (nominal)																										
> 14MHz	22dB	+ 2dB																										
> 30MHz	24dB	-9dB																										
3dB bandwidth (nominal)	Noise factor (nominal)	Gain (nominal)																										
> 14MHz	22dB	+ 2dB																										
> 30MHz	24dB	-4dB																										
> 35MHz	30dB	-10dB																										
> 40MHz	38dB	-18dB																										
> 50MHz	44dB	-24dB																										
<ul style="list-style-type: none"> ● Video output <ul style="list-style-type: none"> Connector Impedance (AC connection) Amplitude (75Ω terminate) 	BNC female, Rear panel 75Ω (nominal) Approx. 1V _{p-p} (Composite video signal)																											

<ul style="list-style-type: none"> ● X axis, 2V/n GHz output <ul style="list-style-type: none"> Connector Impedance X axis output 2V/n GHz 	BNC female, Rear panel 1k Ω (nominal), DC connection approx. -5V to +5V approx. 2V per 1GHz
<ul style="list-style-type: none"> ● Y axis output <ul style="list-style-type: none"> Connector Impedance Amplitude 	BNC female, Rear panel 220 Ω (nominal) approx. 2V in full scale
<ul style="list-style-type: none"> ● Z axis output <ul style="list-style-type: none"> Connector Amplitude During sweep Retrace interval 	BNC female, Rear panel TTL level High level Low level
<ul style="list-style-type: none"> ● External trigger input <ul style="list-style-type: none"> Connector Impedance Trigger level 	BNC female, Rear panel 10k Ω (nominal), DC connection TTL level
<ul style="list-style-type: none"> ● Gate input <ul style="list-style-type: none"> Connector Impedance Sweep stop Sweep 	BNC female, Rear panel 10 k Ω (nominal) During low mode at TTL level During high mode at TTL level
<ul style="list-style-type: none"> ● Probe power <ul style="list-style-type: none"> Voltage Current 	4-pin connector, Front panel + 15V, -15V Max.150mA each
<ul style="list-style-type: none"> ● Voice output (Demodulation audio) <ul style="list-style-type: none"> Connector Power output 	Small-size monophonic jack, Front panel Maximum 0.2W, 8 Ω (nominal)
<ul style="list-style-type: none"> ● GPIB Plotters 	IEEE-488 bus connector R9833, HP7470A, HP7475A, HP7440A, HP7550A

(8) Delay Sweep and Gated Sweep Functions

<p>● DELAY SWEEP</p> <p>Trigger Signal Source</p> <p>DELAY TIME</p> <p>DELAY SWEEP TIME</p>	<p>External trigger input (Enabled to switching the TTL level and rise/fall slope) VIDEO trigger (Enabled to switching the rise/fall slope) TV-V trigger (Enabled to switching the rise/fall slope)</p> <p>200ns to 1.5s Resolution 100ns</p> <p>50μs to 1000s</p>
<p>● GATED SWEEP</p> <p>Trigger Signal Source</p> <p>GATE position</p> <p>GATE width</p>	<p>< F domain analysis > Output trigger input (Enabled to switching the TTL level and rise/fall slope) Gate input (TTL level and rise slope) IF DET trigger (Enabled to switching the rise/fall slope, slew/low-pass filter) Trigger level variable on IF DET monitor The following ranges can be used. Span : 7MHz or less Input pulse width : 100μs or more</p> <p>< TIME domain analysis > External trigger input (Enabled to switching the TTL level and rise/fall slope) Gate input (TTL level and rise slope) IF DET trigger (Enabled to switching the rise/fall slope, slew/low-pass filter) Trigger level variable on IF DET monitor The following ranges can be used. Input pulse width : 100μs or more</p> <p>300ns to 100ms Resolution 100ns</p> <p>1μs to 1.5s Resolution 100ns</p>

(9) General Specifications

<ul style="list-style-type: none"> ● Temperature and humidity <ul style="list-style-type: none"> During operation When stored Relative Humidity 	<ul style="list-style-type: none"> 0°C to 50°C -20°C to 60°C 85% or below
<ul style="list-style-type: none"> ● Power source <ul style="list-style-type: none"> During 100VAC operation <ul style="list-style-type: none"> Voltage Power consumption Frequency During 220VAC operation <ul style="list-style-type: none"> Voltage Power consumption Frequency 	<ul style="list-style-type: none"> 90V to 132V 400VA at maximum 48Hz to 440Hz 198V to 250V 400VA at maximum 48Hz to 66Hz
<ul style="list-style-type: none"> ● Weight 	<ul style="list-style-type: none"> 23kg (nominal) (Excluding optional blocks, front cover, and accessories)
<ul style="list-style-type: none"> ● Dimensions 	<ul style="list-style-type: none"> Approx. 177mm (Height) × 353mm (Width) × 450mm (Depth) (Excluding the handle, legs and front cover)

APPENDIX

A.1 Glossary

IF Bandwidth

The spectrum analyzer uses band pass filter (BPF) to analyze the frequency components contained in the input signal. The 3dB bandwidth of the BPF is called the IF band (See Figure A-1(a)).

The BPF characteristics should be set according to the sweep width and the sweep speed used for the waveform. This spectrum analyzer sets the optimal value according to the sweep width. In general, smaller bandwidths improve resolution. Therefore, the resolution of the spectrum analyzer can be expressed by the narrowest IF bandwidth (See Figure A-1 (b)).

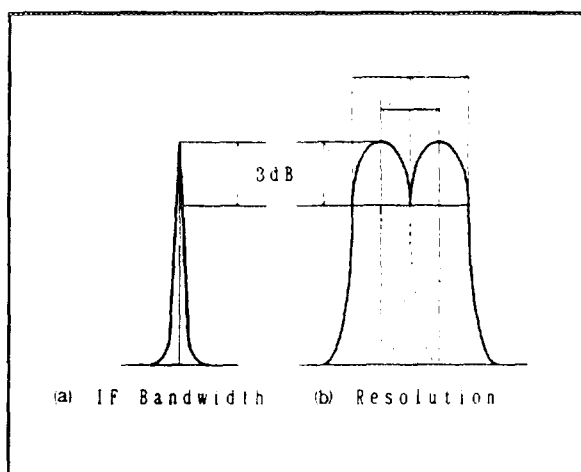

Figure A-1 IF Bandwidth

Electromagnetic compatibility (EMC)

The ability of a system to operate without producing or being affected by electromagnetic interference.

Electromagnetic interference (EMI)

Electromagnetic interference (EMI) is a disturbance in the reception of desired signals caused by unwanted electromagnetic energy, or something. EMI can be caused by any source of EM energy, such as (list a pertinent rev). Modern circuits are designed to produce as little EM energy as possible, but since the EM can not be completely eliminated, the cabinets containing EM-can not equipment are shielded to exclude EMI.

Reference Level Display Accuracy

When reading the absolute level of an input signal on the spectrum analyzer, the level is determined by the distance in dB from the uppermost scale on the screen. The level set for this uppermost scale is called reference level.

The reference level is modified by the IF GAIN key and the input attenuator, and displayed in dBm or dB μ . The absolute accuracy of this display is the reference level accuracy.

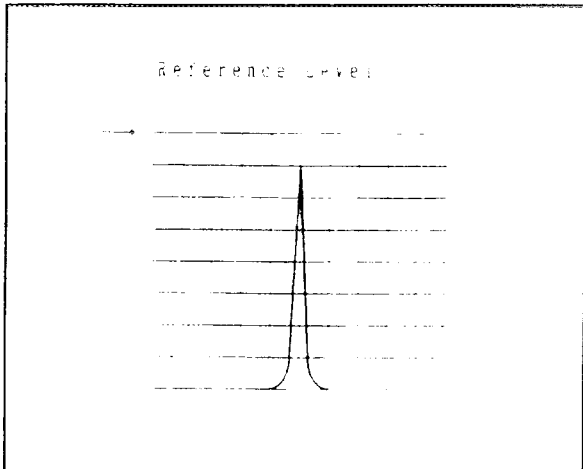

Figure A-2 Reference Level

Gain Compression

If the input signal is greater than a certain value, the correct value is not displayed on the CRT and the input signal appears as if it were compressed. This phenomenon is called gain compression, and it expresses the linearity of the input signal range. Max gain compression is 1dB.

Maximum Input Sensitivity

This is the maximum sensitivity of the spectrum analyzer to detect signals. The sensitivity is affected by the noise generated by the spectrum analyzer itself and depends on the IF bandwidth. The maximum input sensitivity is normally expressed as the average noise level in the minimum IF bandwidth of the spectrum analyzer.

Maximum Input Level

This is the maximum level allowed for the input circuit of the spectrum analyzer. The level can be modified by the input attenuator.

Residual FM

The short-period frequency stability of the local oscillators built in the spectrum analyzer is expressed as residual FM. The frequency width fluctuating per unit time is expressed by p-p. This also determines the measurement limit value when measuring the residual FM of the signal.

Residual Response

Residual response is a measure of how much (in the input level calculation) the spurious signal generated in the spectrum analyzer is suppressed. Residual response is generated by leaks of particular signals such as local oscillation output in the spectrum analyzer. This should be taken into consideration when analyzing a precise input signal.

Quasi-Peak Value Measurements

In radio communication, EMI usually appears as an impulse. To evaluate this interference, the analyzer uses the noise power in proportion to the peak value. The measurement bandwidth and detection constant used for this evaluation are called quasi-peak value measurements, and are determined by JRTC specifications (in Japan) and CISPR specifications (international).

Frequency Response

This term represents amplitude characteristics (frequency characteristics) for a given frequency. In the spectrum analyzer, frequency response means the frequency characteristics (flatness) of input attenuator and mixer for the input frequency, and is given in $\pm \Delta$ dB.

Zero Span

The spectrum analyzer sweeps at any frequency along the horizontal axis as the time axis but will not sweep in zero span mode.

Occupied Bandwidth

Modulation causes the frequency spectrum of an EM signal to spread significantly. The occupied bandwidth is the portion of the signals that contains 99% of the total average power radiated (See Figure A-3).

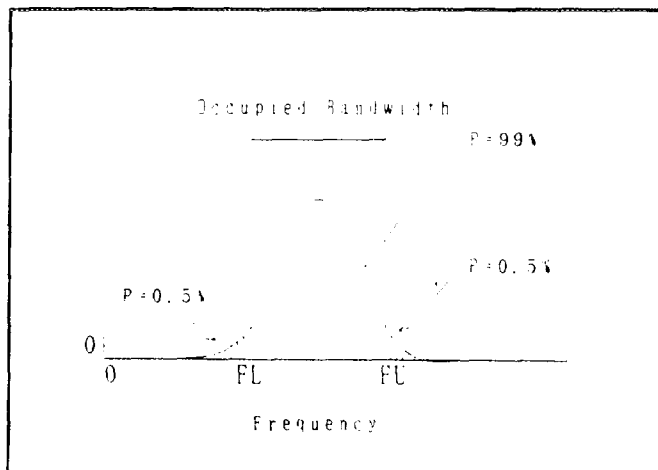

Figure A-3 Occupied Bandwidth

Spurious Signals

Spurious signals are undesired signals that can interfere with the target signal. Spurious signals can be divided into several types as follows:

- Higher Harmonic spurious : This is the higher harmonic level generated by the spectrum analyzer itself (normally in the mixer circuit) when an ideal undistorted signal is fed to the analyzer. This also means the efficiency to measure higher harmonic distortion.
- Adjacent spurious : This is the small spurious signal generated in the vicinity of the spectrum when a pure, single-spectrum signal is fed to the spectrum analyzer.
- Non-higher Harmonic spurious : This is a spurious signal of a certain inherent frequency generated by the spectrum analyzer itself. This is also called residual response.

Spurious Response

This is distortion caused by the higher harmonic spurious signal generated in the input mixer when the signal level is increased. The range that can be used without distortion varies according to the input level of the basic wave. In the example shown Figure A-4, the range is from -30dBm to -70dB. If the input signal level is too great, the input attenuator is used to decrease the signal fed to the mixer so that a proper input level can be obtained.

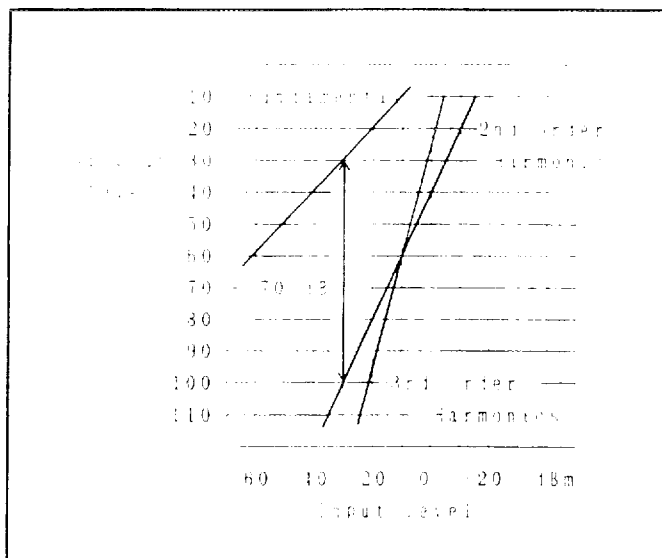

Figure A-4 Spurious Response

Noise Sideband

The spectrum analyzer efficiency is lowered by the noise generated in the local oscillator and phase lock loop of the analyzer itself, which will appear in the vicinity of the spectrum on the CRT. To compensate for this, the sideband of the analyzer itself is defined so that signals out of the sideband can be analyzed in a certain range. This range is called the noise sideband.

The spectrum analyzer's noise sideband characteristics are expressed in the following example.

Example: Suppose the IF bandwidth is 1kHz, -70dB at 20kHz apart from the carrier. The noise level is normally expressed by the energy contained in the 1Hz bandwidth. (See Figure A-5 (b).)

If this is expressed in 1Hz bandwidth: Since the value is -70dB when the bandwidth is 1kHz, the signals within the 1Hz bandwidth will be lower than this by about $10 \log 1\text{Hz}/1\text{kHz}$ [dB], or about 30dB; consequently, it is expressed as -100dB/Hz at 20kHz apart from the carrier when the IF bandwidth is 1kHz.

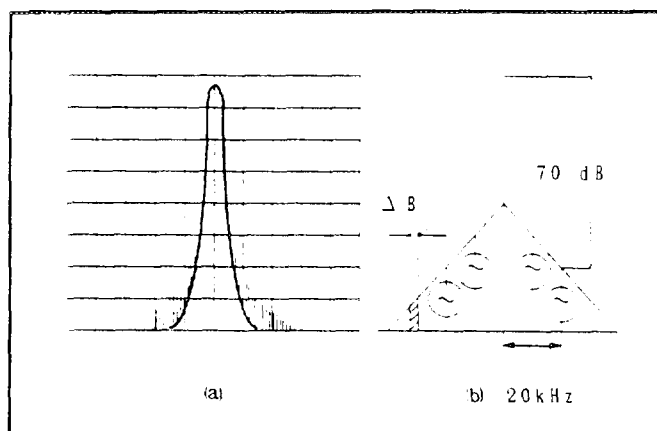

Figure A-5 Noise Sideband

Resolution Bandwidth Selectivity

The band pass filter normally attenuates Gauss distribution instead of so-called rectangular characteristics. Consequently, if two adjacent signals of different sizes are mixed, the smaller signal "hides" at the tail of the larger signal (See Figure A-6). Therefore, the bandwidth at a certain attenuation range (60dB) should also be defined. The ratio between the 3dB width and 60dB width is expressed as the bandwidth selectivity.

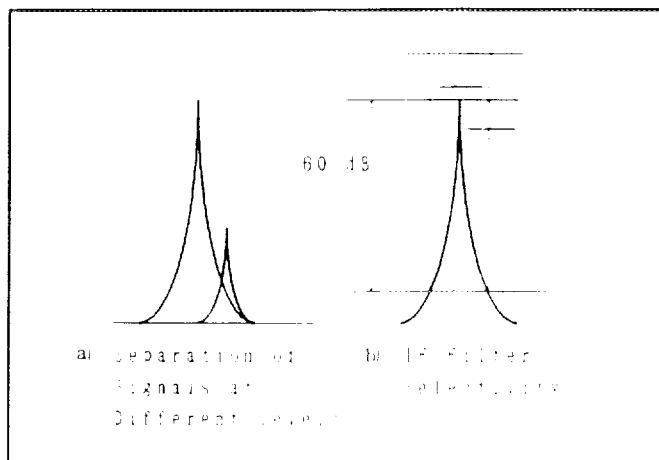

Figure A-6 Bandwidth Selectivity

Bandwidth Accuracy

The bandwidth accuracy of the IF filter is expressed by the deviation from the nominal value of the 3dB-lowered point. This efficiency has almost no effect on measurement of normal signals of continuous level, but it should be taken into consideration when measuring the level of a noise signal.

Bandwidth Switching Accuracy

Several IF filters are used to obtain optimal resolution (in signal spectrum analysis) according to the scan width. When switching from one IF filter to another while measuring one and the same signal, an error is generated for the difference in loss. This error defined as the bandwidth switching accuracy.

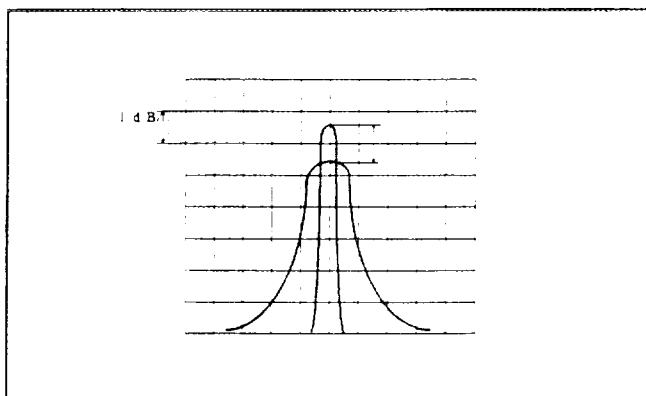

Figure A-7 Bandwidth Switching Accuracy

Voltage Standing Wave Ratio (VSWR)

This is a constant that represents the impedance matching state. It is expressed as the ratio between the maximum and minimum values in the standing wave generated as a combination of progressive wave and reflected wave in the spectrum analyzer loaded against the ideal nominal impedance source. This is a variation of reflection factor and reflection attenuation amount.

In Figure A-8, the value of signal E_1 received at the receiver (spectrum analyzer input) is identical to that of E_0 if E_0 is transmitted to the receiver without impedance mismatching. If the signal is completely reflected due to mismatching of the receiver and returned to the transmitter, the ratio of reflection, i. e., the reflection factor can be expressed as follows, assuming ER as the reflected wave size:

Reflection factor $\Gamma = \text{Reflected wave ER} / \text{Progressive wave } E_0$

Return loss (dB) = $20 \log ER / E_0$ [dB]

$VSWR = (E_0 + ER) / (E_0 - ER)$

The relationship to the reflection factor will be:

$VSWR = (1 + |\Gamma|) / (1 - |\Gamma|)$

The VSWR will be in the range 1 to ∞ . The matching state is improved as the value approaches 1.

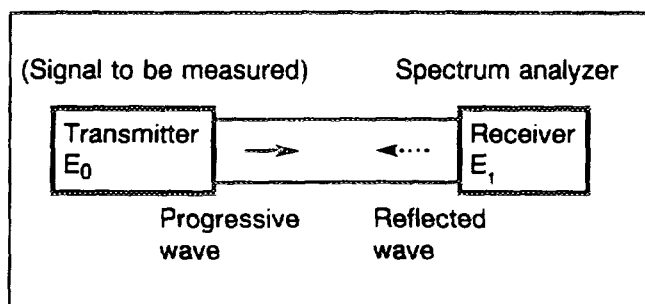

Figure A-8 VSWR

YIG-tuned Oscillator

This was first reported by Griffiths in 1946. Garnet ferrites such as YIG (Yttrium-iron garnet) monocrystal show extremely sharp electron spin resonance in the microwave area, and has a resonance frequency in proportion to the direct-current magnetic field applied over a wide frequency range. Therefore, YIG crystals can be used for wide-range electronic tuning, changing the current exciting the elector magnet that generates direct current magnetic field. YIG crystals are used in the local sweep generator of the spectrum analyzer and in other devices such as auto microwave frequency counters.

A. 2 Level Scalings

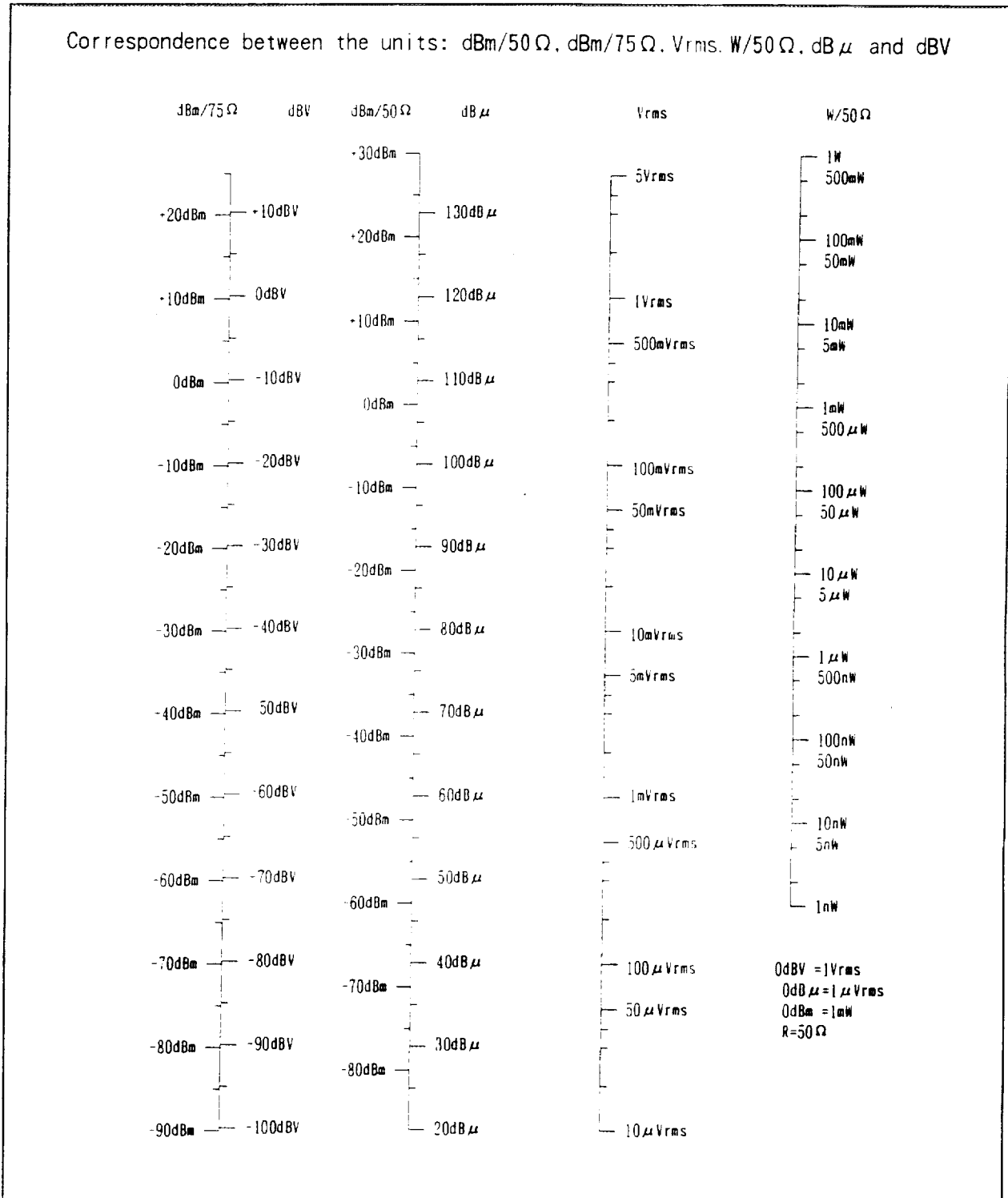
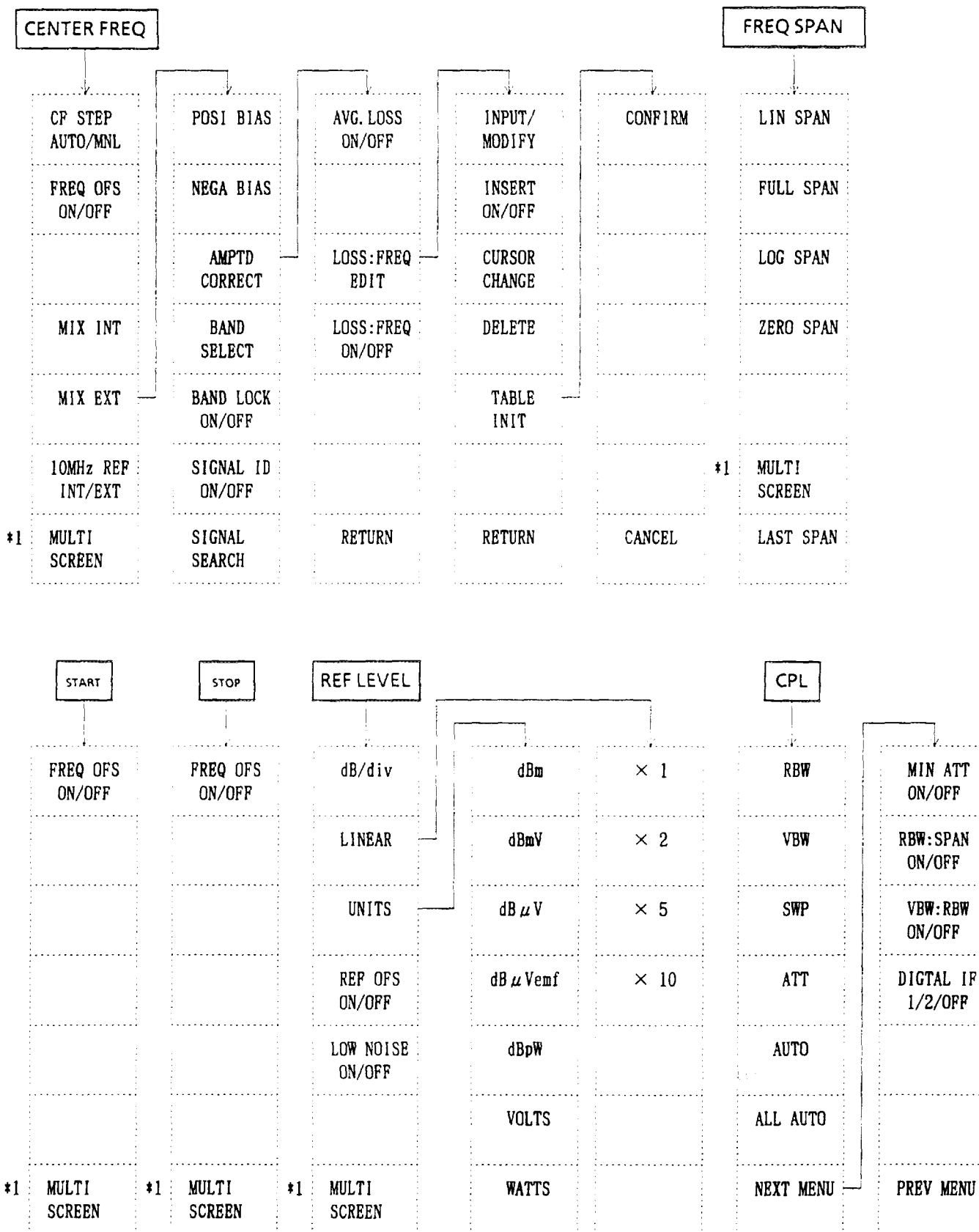

Figure A-9 Level Scalings

A.3 Menu Lists



*1 : MULTI-SCREEN menu is displayed only when the split-screen (2 sections) mode is selected. A-9

MENU					
TRIG	AM/FM	CONT SWP	POSI-NEGA	FREE RUN	ODD FIELD
TRACE DET	VOLUME	MANUAL SWP	POSI	LINE	EVEN FIELD
SWEEP MODE	MKR PAUSE TIME	SINGLE SWP	NEGA	VIDEO	
SOUND	SQUELCH ON/OFF		SAMPLE	TV-V	
DSP LINE ON/OFF	AM AGC ON/OFF	WINDOW SWP		TV-H	
ARTIFICIAL ANALOG		RESET SWP		EXT	
NEXT MENU	SOUND OFF	MKR PAUSE ON/OFF		SLOPE +/-	RETURN

CHAR DSP ON/OFF	X AXIS	ART ANLG ON/OFF	X CURSOR ON/OFF
GRATICULE ON/OFF	LO. SWP 2V/GHz	CONTINUE /PAUSE	X CURSOR NORMAL
FREQ DSP ON/OFF		RATE 20	X CURSOR Δ
INPUT RF/PI		MKR ON/OFF	Y CURSOR ON/OFF
INPUT 50/75 Ω		\longleftrightarrow $\uparrow \downarrow$ 1/20	Y CURSOR NORMAL
REAR PNL OUTPUT		$\Delta X / \Delta Y$ CURSOR	Y CURSOR Δ
PREV MENU	RETURN	PREV MENU	PREV MENU

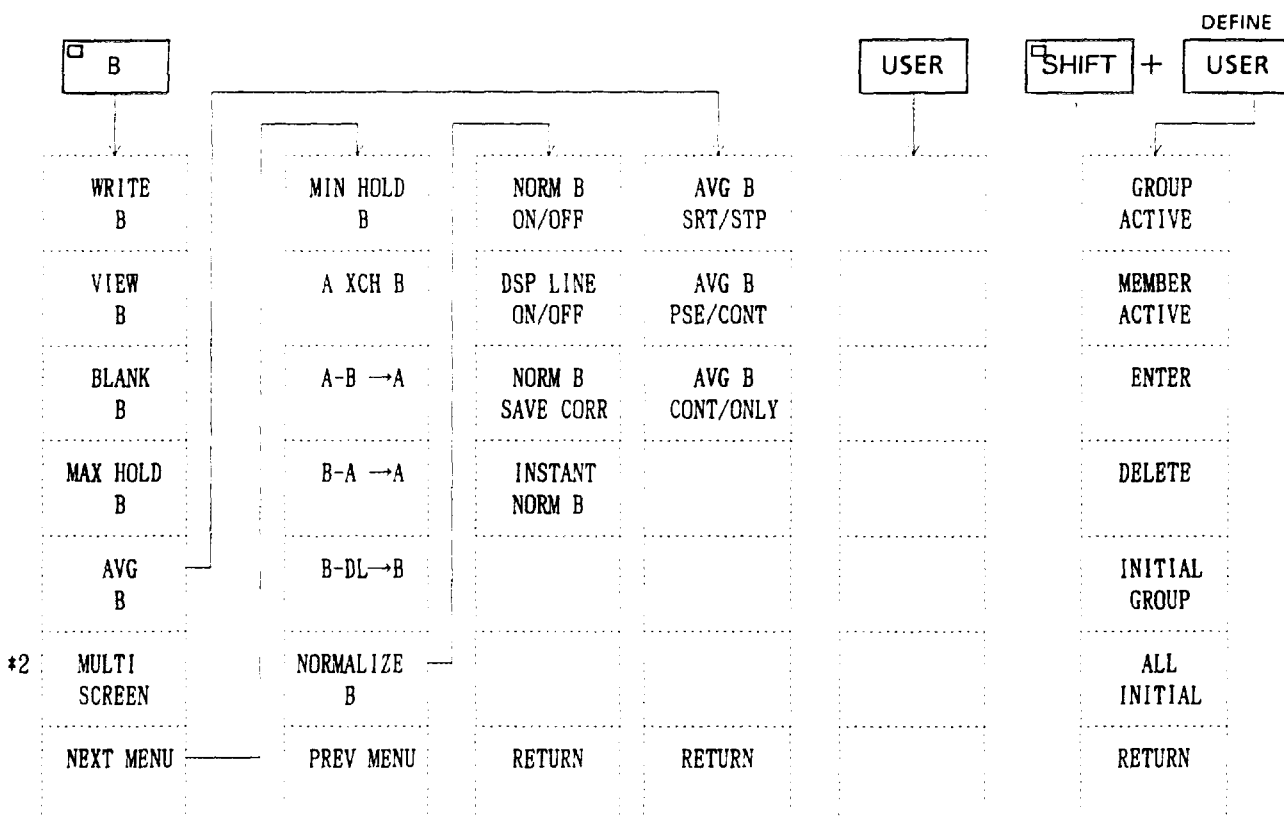
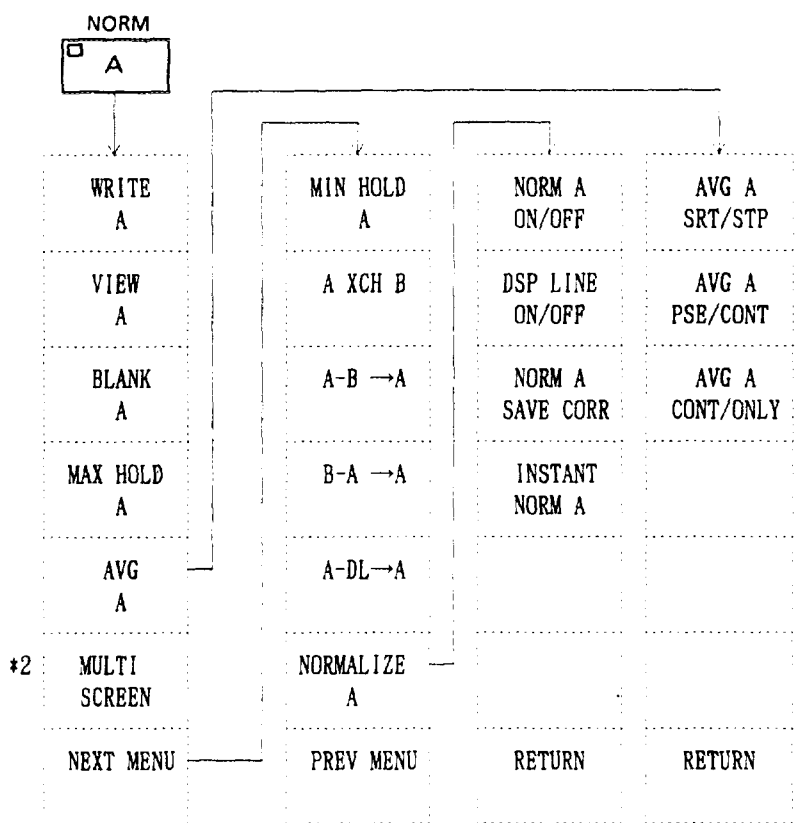

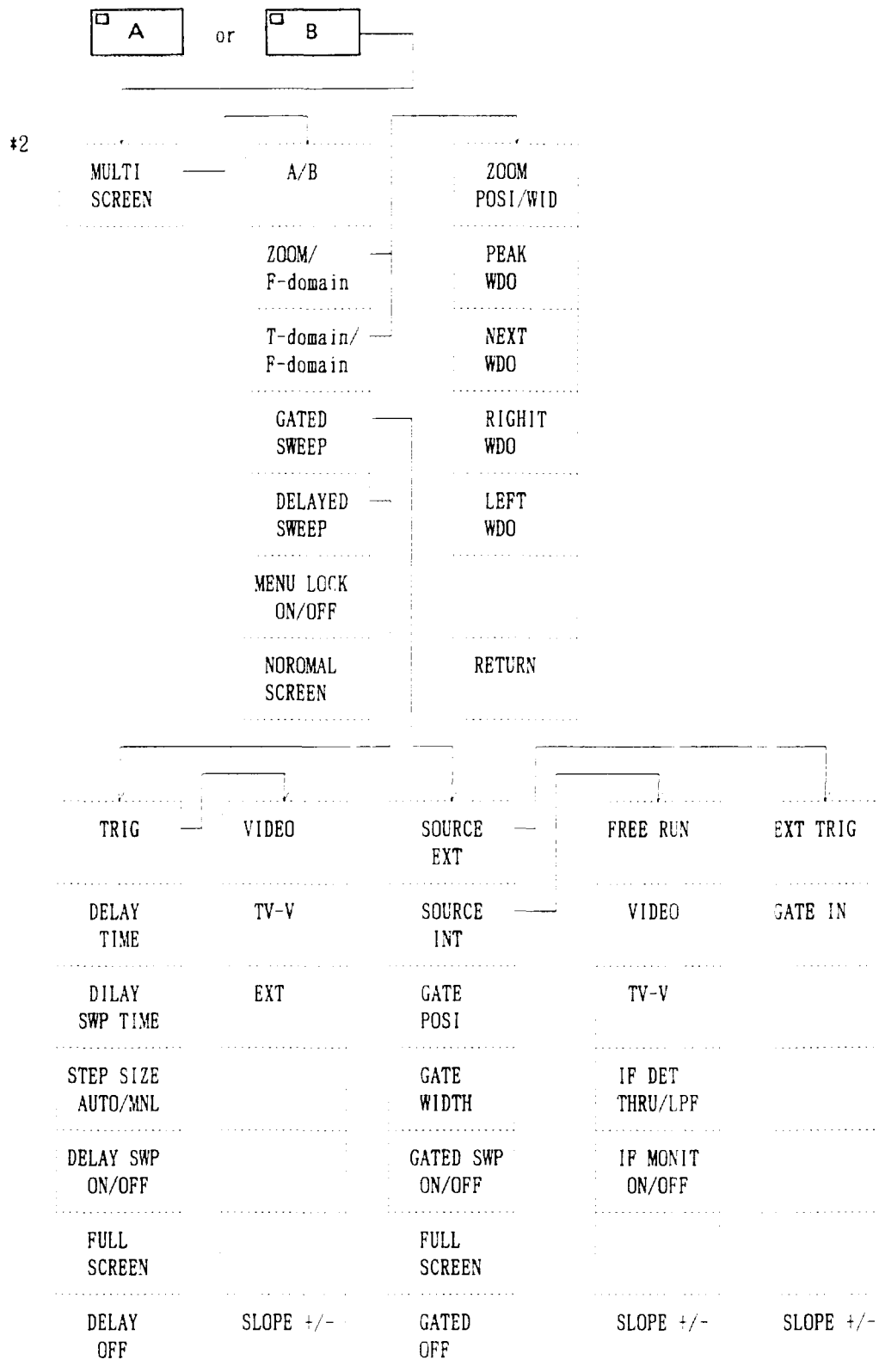

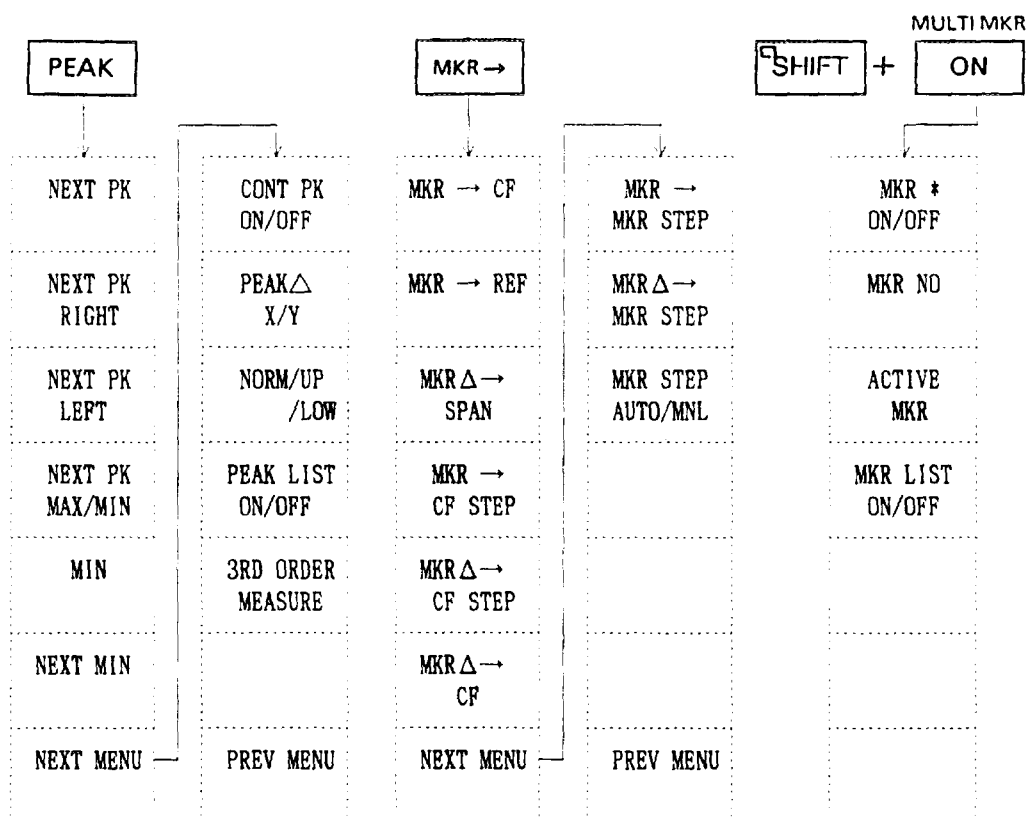
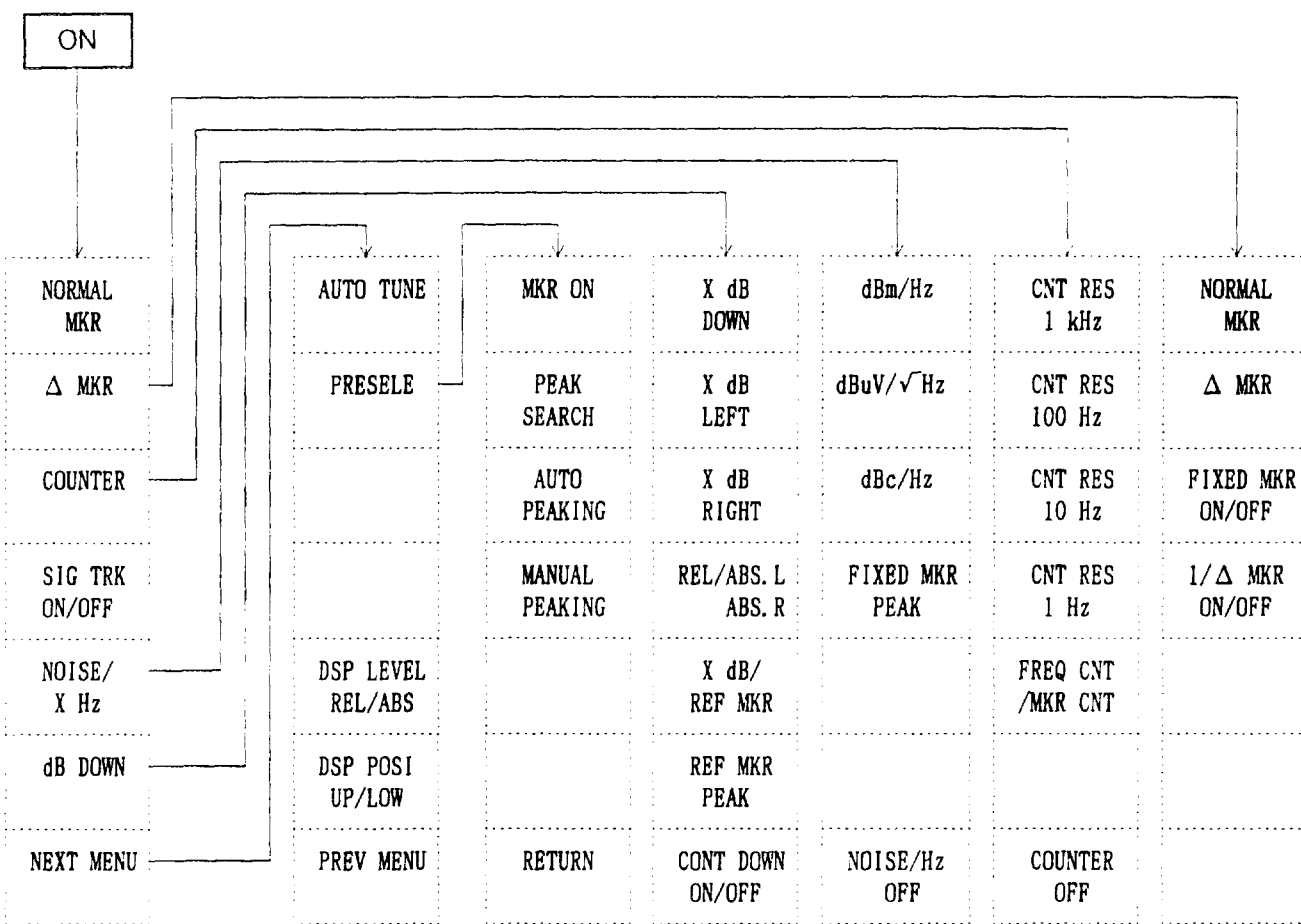

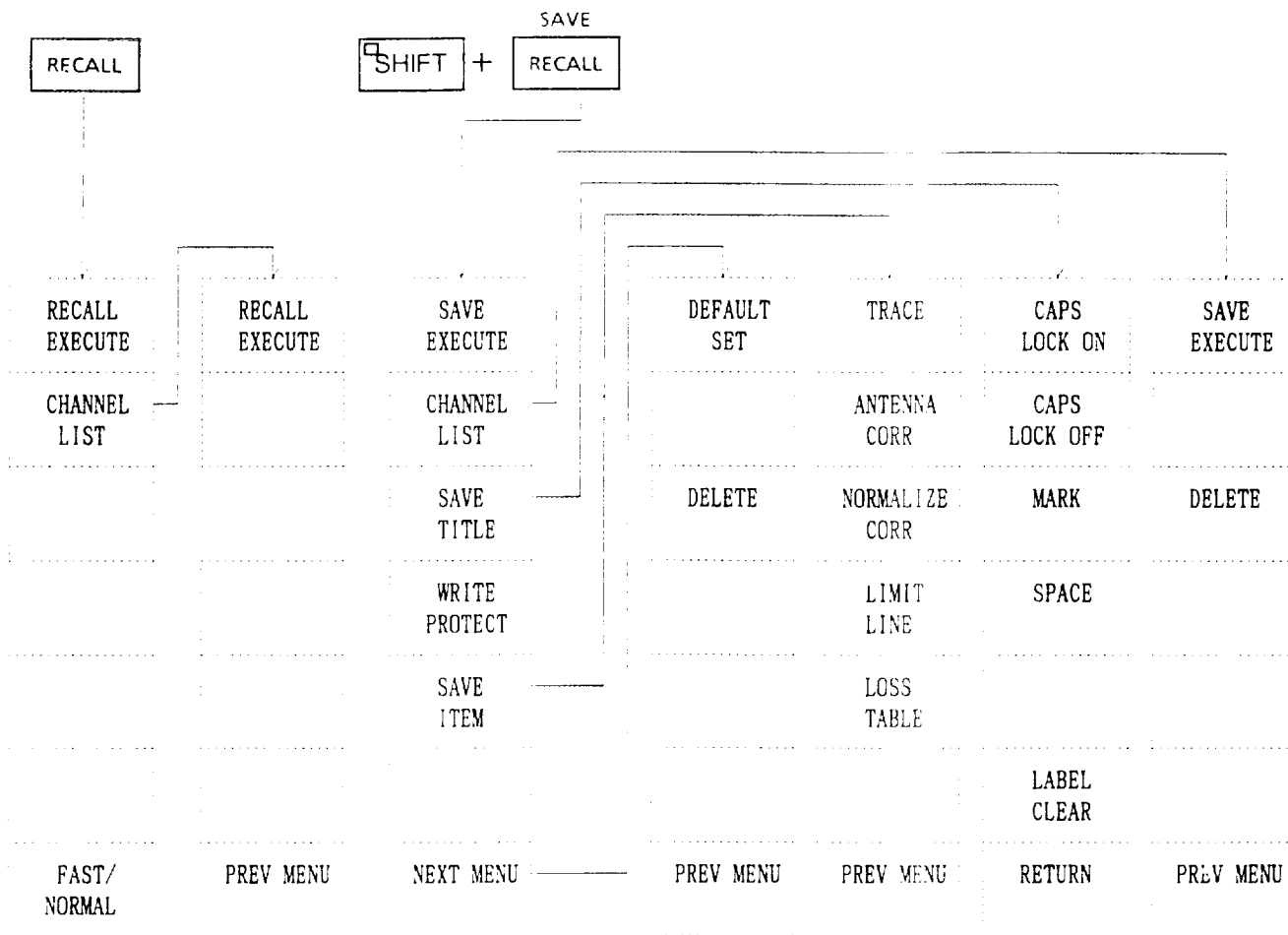

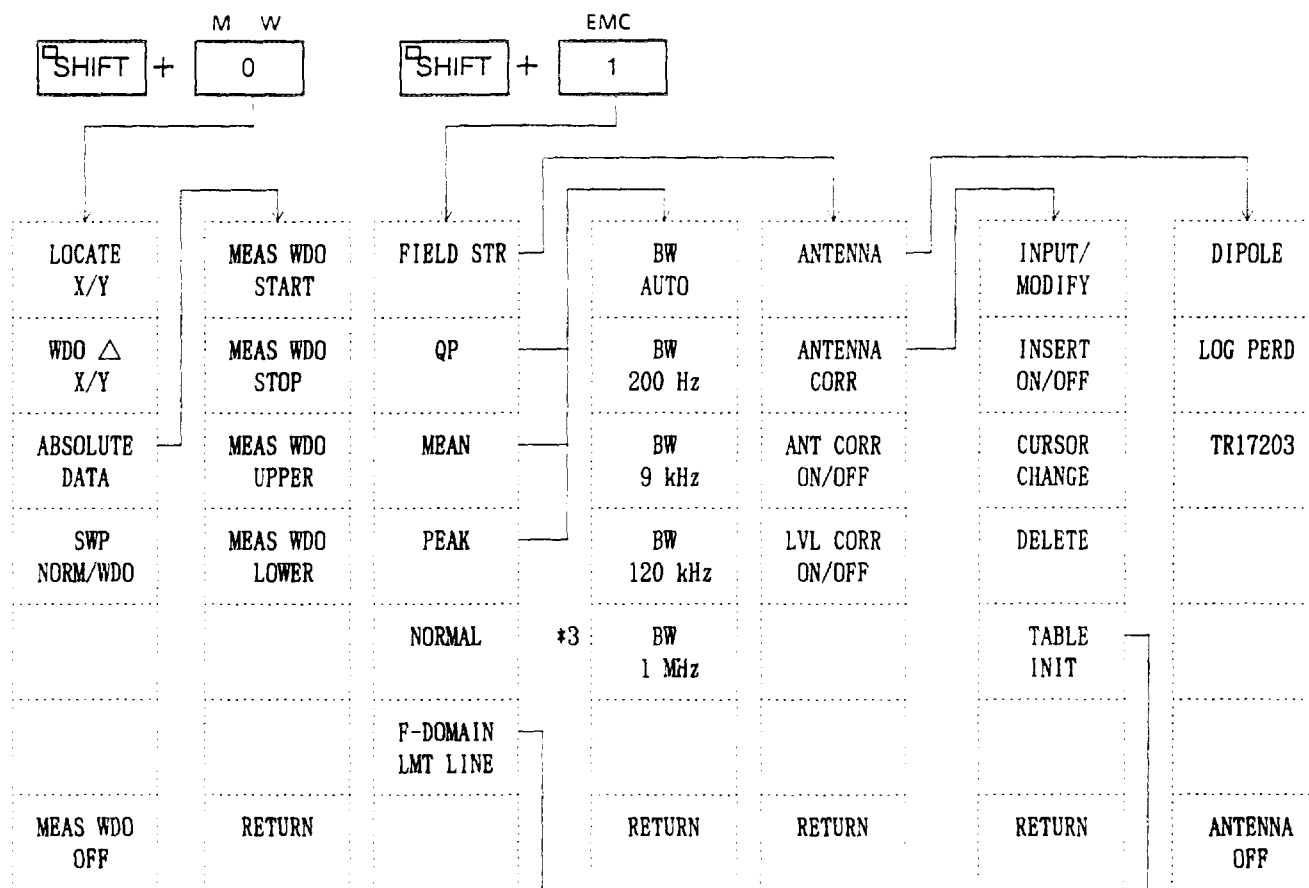

*3: Only when the previous menu is PEAK, BW 1MHz is displayed.

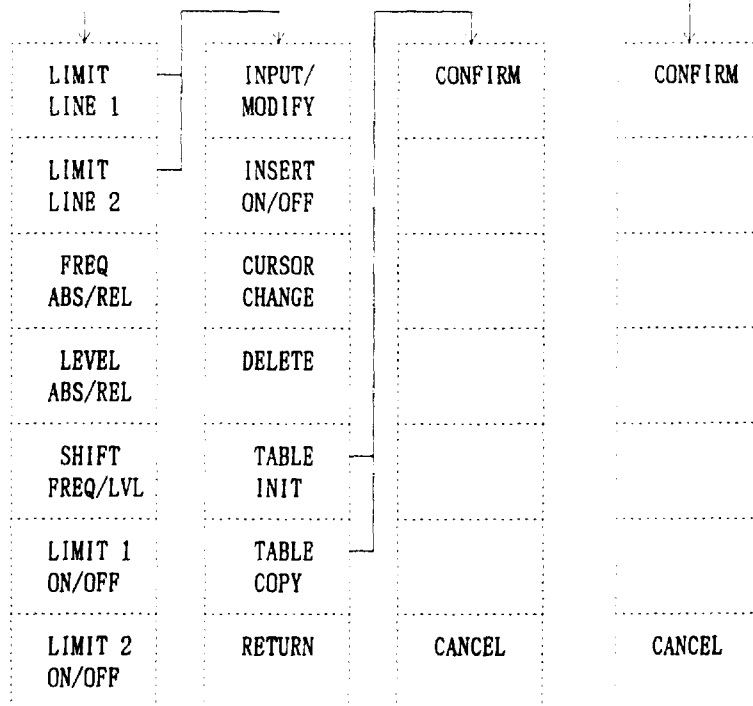

SHIFT + DATE 2 SHIFT + UTIL 3

YEAR	OBW	ADJ 2	LIMIT LINE 1	INPUT/ MODIFY
MONTH	ADJ SETUP CH SP/BS	T-DOMAIN LMT LINE	LIMIT LINE 2	INSERT ON/OFF
DAY	ADJ POINT	POWER MEAS	TIME ABS/REL	CURSOR CHANGE
HOURL	ADJ GRAPH		LEVEL ABS/REL	DELETE
MIN	ADJ GRAPH OFF	LMT LINE PASS/FAIL	SHIFT TIME/LVL	TABLE INIT
SEC ADJ	PEAK	√NQST FLT	LIMIT 1 ON/OFF	TABLE COPY
ON(1/2/3) / OFF	NEXT MENU	PREV MENU	LIMIT 2 ON/OFF	RETURN

SHIFT + MEM CD 4

LOAD MENU	CONFIRM	√NQST FLT ON/OFF	TRACE A/B	AVG TIMES	CONFIRM
STORE MENU		PRESET JDC MODE	CONT P/F ON/OFF	AVG POWER ON/OFF	
		PRESET NADC MODE	PASS/FAIL EXECUTE	TOTAL PWR ON/OFF	
LOAD BACKUP		SYM RATE 1/T			
STORE BACKUP		ROLE FACT <i>α</i>			
CARD FORMAT	CANCEL	RETURN	RETURN	RETURN	CANCEL

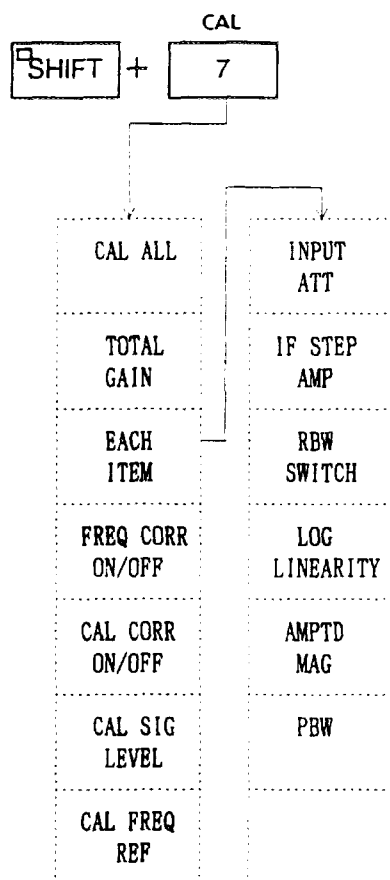
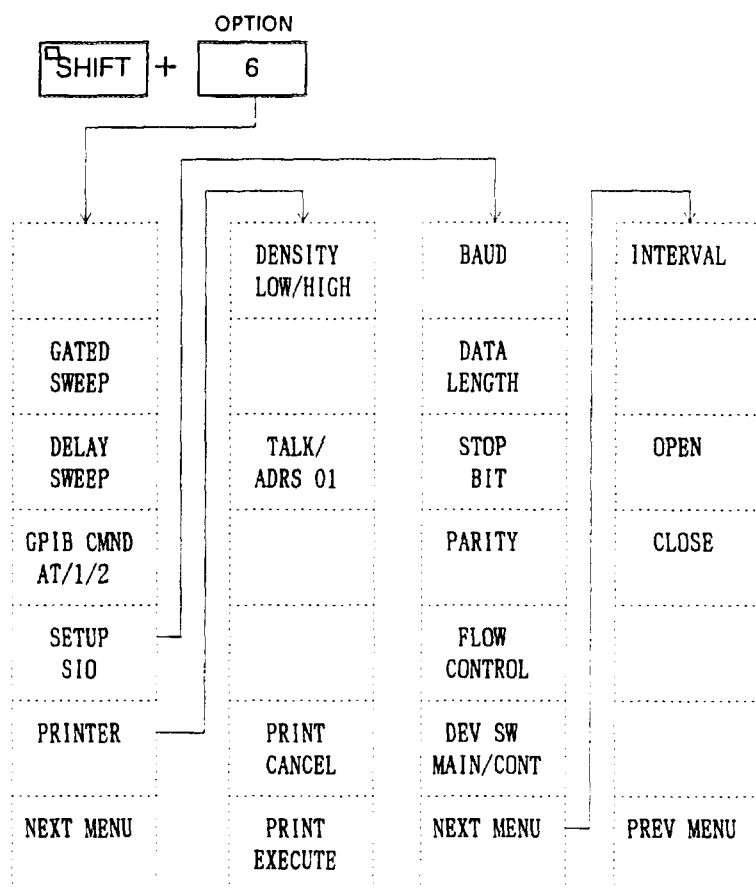

SHIFT + PLOT
8

SHIFT + LABEL
9

PLOTTER TYPE	PAPER SIZE
PLOT MODE	PEN
TABLE	PLOT DIVISION
PLOT FORM	LOCATION
LOCATE AUTO/MNL	
PLOT CANCEL	TAIK/ADRS 05
PLOT EXECUTE	RETURN

CAPS LOCK ON
CAPS LOCK OFF
MARK
SPACE
LABEL CLEAR
RETURN

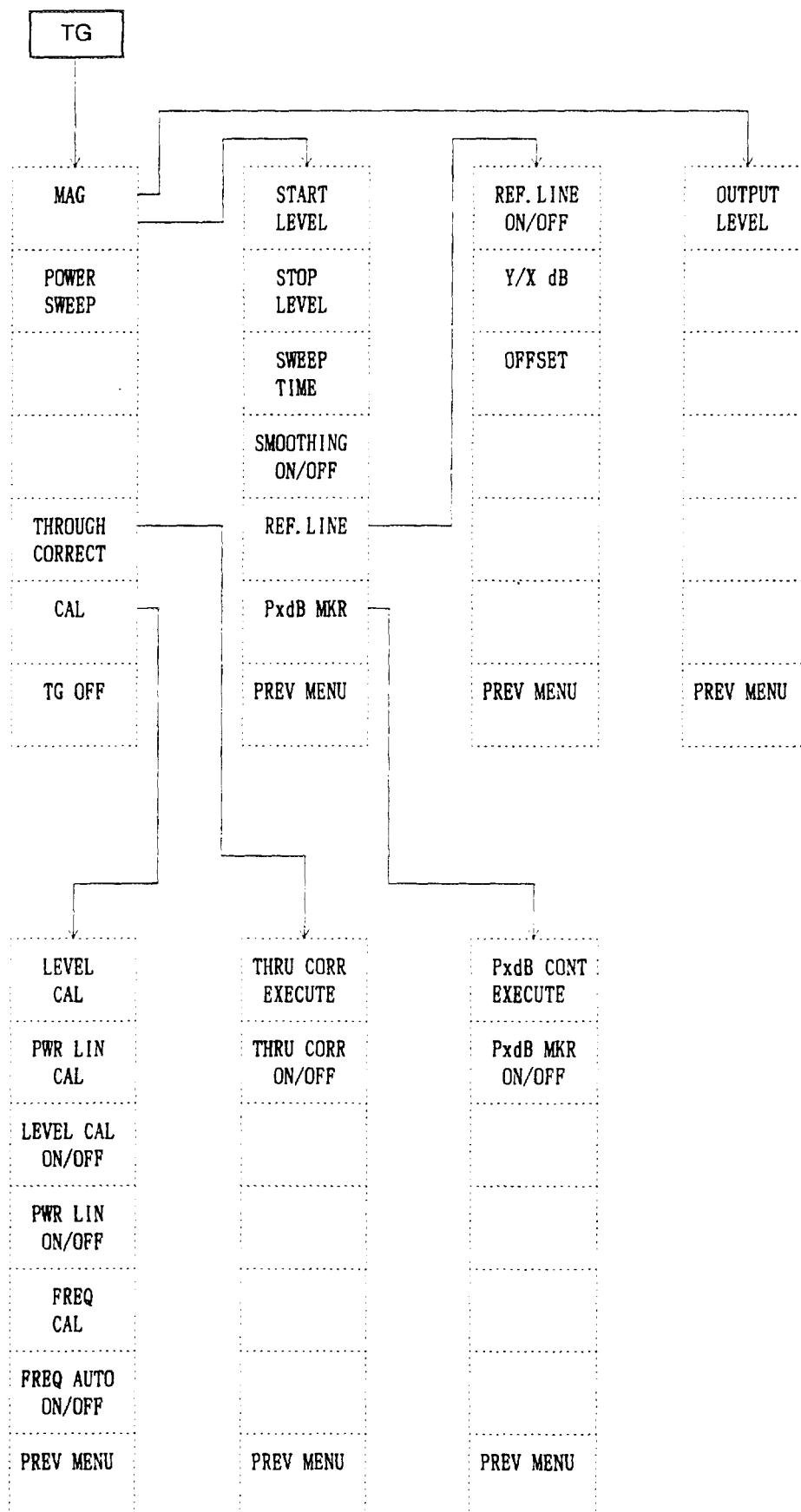

A.4 List of Messages

This appendix lists and explain the messages that may appear on the analyzers screen.

Message	Description
"A/D calibration failure"	A/D calibration failed.
"All copied" (NOTE message)	All items have been copied.
"All deleted" (NOTE message)	All items have been erased.
"Antenna correction mode is OFF"	The antenna correction mode is off.
"Calibration error of AMPTD MAG"	An error was detected in the AMPTD MAG.
"Calibration error of IF STEP AMP"	An error was detected in the IF STEP AMP.
"Calibration error of INPUT ATT"	An error was detected in the INPUT ATT.
"Calibration error of LOG LINEARITY"	An error was detected in the LOG LINEARITY.
"Calibration error of RBW SWITCH"	An error was detected in the RBW SWITCH.
"Calibration error of TOTAL GAIN"	An error was detected in the TOTAL GAIN.
"Calibration signal not detected"	The calibration signal could not be detected.
"Cannot save in this memory area"	The analyzer cannot save in this memory area because the area is write-protected.
"Cannot select Trace B while Limit Line On"	The B trace cannot be selected because limit line 1 or 2 is on.
"Caution!! Freq. & Plug-in corr. data abnormal"	The correction data has been destroyed.
"Completed" (NOTE message)	The default value setting for IP is completed.
"Conversion loss mode is OFF"	The conversion loss mode is off.
"Do you really want to initialize Memory Card?" (REQUEST message)	The system makes sure you really want to initialize the memory card.
"Do you really want to load Backup data?" (REQUEST message)	The system makes sure you really want to load the backup data.

Message	Description
"Do you really want to store backup memory?" (REQUEST message)	The system makes sure you really want to load the backup data to the card.
"File Access completed" (NOTE message)	File access is completed.
"Freq. domain data exists, do you really want to delete it?" (REQUEST message)	The system makes sure you really want to delete the frequency domain.
"Limit line vol. 1 is OFF"	Limit line 1 is off.
"Limit line vol. 2 is OFF"	Limit line 2 is off.
"Marker is inactive"	No marker is active.
"Memory Card Access error (Parameter)"	Access failed due to incorrect internal parameters.
"Memory Card Access error (RAM check)"	Access failed due to memory card RAM error.
"Memory Card Access failed (Antenna data)"	The antenna data cannot be accessed.
"Memory Card Access failed (Limit 1 data)"	The limit line 1 data cannot be accessed.
"Memory Card Access failed (Limit 2 data)"	The limit line 2 data cannot be accessed.
"Memory Card Access failed (Loss data)"	The conversion loss data cannot be accessed.
"Memory Card Access failed (Menu data)"	The menu data cannot be accessed.
"Memory Card Access failed (Norm. A data)"	The Normalize A data cannot be accessed.
"Memory Card Access failed (Norm. B data)"	The Normalize B data cannot be accessed.
"Memory card Access failed (Setting Data)"	The setting data cannot be accessed.
"Memory Card Access failed (Soft Protect)"	Access failed due to soft protect (file attribute, etc.).
"Memory Card Access failed (Sum data)"	The check sum data cannot be accessed.
"Memory Card Access failed (Trance A data)"	The A trace data cannot be accessed.

Message	Description
"Memory Card Access failed (Trace B data)"	The B trace data cannot be accessed.
"Memory Card Card access error (FAT)"	Access failed due to a file area table error.
"Memory Card Card access error (UAT)"	Access failed due to a user area table error.
"Memory Card Data entry overflow"	The saved data exceeds the memory card's capacity.
"Memory Card Deleted" (NOTE message)	The memory card has been cleared.
"Memory Card Deletion error (Parameter)"	The memory card cannot be cleared due to a parameter error.
"Memory Card File Access completed" (NOTE message)	The soft menu or the BACKUP MEMORY data has been stored or loaded.
"Memory Card File not found"	The file specified could not be found.
"Memory Card File type unmatched"	The file type did not match.
"Memory Card Init. error (Card size)"	Initialization failed due to incorrect memory card size.
"Memory Card Init. error (Parameter)"	Initialization failed due to incorrect internal parameters.
"Memory Card Init. error (RAM check)"	Initialization failed due to faulty memory card RAM.
"Memory Card Init. error (System Protect)"	The system card cannot be initialized.
"Memory card Initialized" (NOTE message)	Initialization is complete.
"Memory Card Memory Card full"	The memory card is full.
"Memory card Not enough memory, 64KB is required"	The memory card capacity is insufficient to back-up the storage.
"Memory Card Not Initialized"	The memory card has not been initialized.
"Memory Card Password unmatched"	The password was incorrect.

Message	Description
"Memory Card Product code unmatched"	The product code of the memory is unmatched.
"Memory Card Write failed (Write Protect)"	Write failed due to write protect.
"Memory protected"	The protected file cannot be accessed.
"Memory table full"	The memory table is full.
"Multi marker list or next peak list is ON"	Label cannot be displayed because the multi marker list or next peak list is displayed.
"No multi marker list or no next peak list"	No multi marker list or no next peak list is displayed.
"No peak point"	No peak point can be retrieved.
"Not available in QP, MEAN or PEAK mode"	This function is not available in QP, MEAN, or PEAK mode.
"Not available in A avg or A min mode"	This function is not available in MIN HOLD A or AVG A mode.
"Not available in A max or A avg mode"	This function is not available in MAX HOLD A or AVG A mode.
"Not available in A max or A min mode"	This function is not available in MAX HOLD A or MIN HOLD A mode.
"Not available in B avg or B min mode"	This function is not available in MIN HOLD B or AVG B mode.
"Not available in B max or B avg mode"	This function is not available in MAX HOLD B or AVG B mode.
"Not available in B max or B min mode"	This function is not available in MAX HOLD B or MIN HOLD B mode.
"Not available in Blank Trace"	This function is not available when trace mode is set to BLANK.
"Not available in Cont. dB Down mode"	This function is not available when Continuous dB Down mode is ON.
"Not available in Counter mode"	This function is not available when Counter mode is ON.
"Not available in Diigital IF mode"	This function is not available when the display is set to FFT mode.
"Not available in Ext. Mixer mode"	This function is not available in Ext. Mixer mode.
"Not available in High Speed A/D"	This function is not available in HIGH SPEED A/D mode.

Message	Description
"Not available in Linear scale"	This function is not available in linear scale display mode.
"Not available in Log Span mode"	This function is not available LOG SPAN mode.
"Not available in Manual Sweep mode"	This function is not available in MANUAL SWEEP mode.
"Not available in Noise/Hz mode"	This function is not available in Noise/Hz mode.
"Not available in QP mode"	This function is not available in QP mode.
"Not available in QP or MEAN mode"	This function is not available in QP or MEAN mode.
"Not available in Signal Indent mode"	This function is not available in SIGNAL INDENT mode.
"Not available in Zero Span mode"	This function is not available in ZERO SPAN mode.
"Not available on baseband frequency"	This function is not available while the marker is on the base band.
"Not available while Signal Tracking"	This function is not available during SIGNAL TRACK execution.
"Not available Antenna correction is ON"	This function is not available in ANTENNA CORR mode.
"Plotter is busy or inactive"	The plotter is busy or inactive.
"RAM broken (Backup Memory)"	The backup memory RAM has been destroyed.
"RAM broken (Memory Card)"	The memory card RAM has been destroyed.
"Set up data is insufficient Please enter ADJ set up"	No ADJ SET UP data is set, or is set incorrectly.
"System busy" (NOTE message)	Another process is being executed. The analyzer is busy.
"Time domain data exists, do you really want to delete it?" (REQUEST message)	The system makes sure you really want to delete the time domain data.
"VCO calibration failure"	VCO calibration failed.

Message	Description
"Vertical scale factor not correct Select 10 dB/div scale"	The reference scale must be set to 10dB/div for this function to execute.
"10MHz reference fixed" (NOTE message)	The reference data is fixed.
"Not available in magnitude mode"	This function is not available in MAGNITUDE mode.
"Not available in power sweep mode"	This function is not available in POWER SWEEP mode.
"TG output signal not detected"	TG output signal was not detected.
"No correction data Please execute "CAL ALL", again"	Correction data is not given. Execute "CAL ALL" again.
"Correction data is invalid Please "PWR LIN CAL", again"	Correction data is invalid. Execute "PWR LIN CAL" again.
"Correction data is invalid Please "LEVEL CAL", again"	Correction data is invalid. Execute "LEVEL CAL" again.
"Calibration error of PWR LIN CAL"	Error was occurred in PWR LIN CAL.
"Calibration error of LEVEL CAL"	Error was occurred in LEVEL CAL.
"Calibration error of FREQ CAL"	Error was occurred in FREQ CAL.

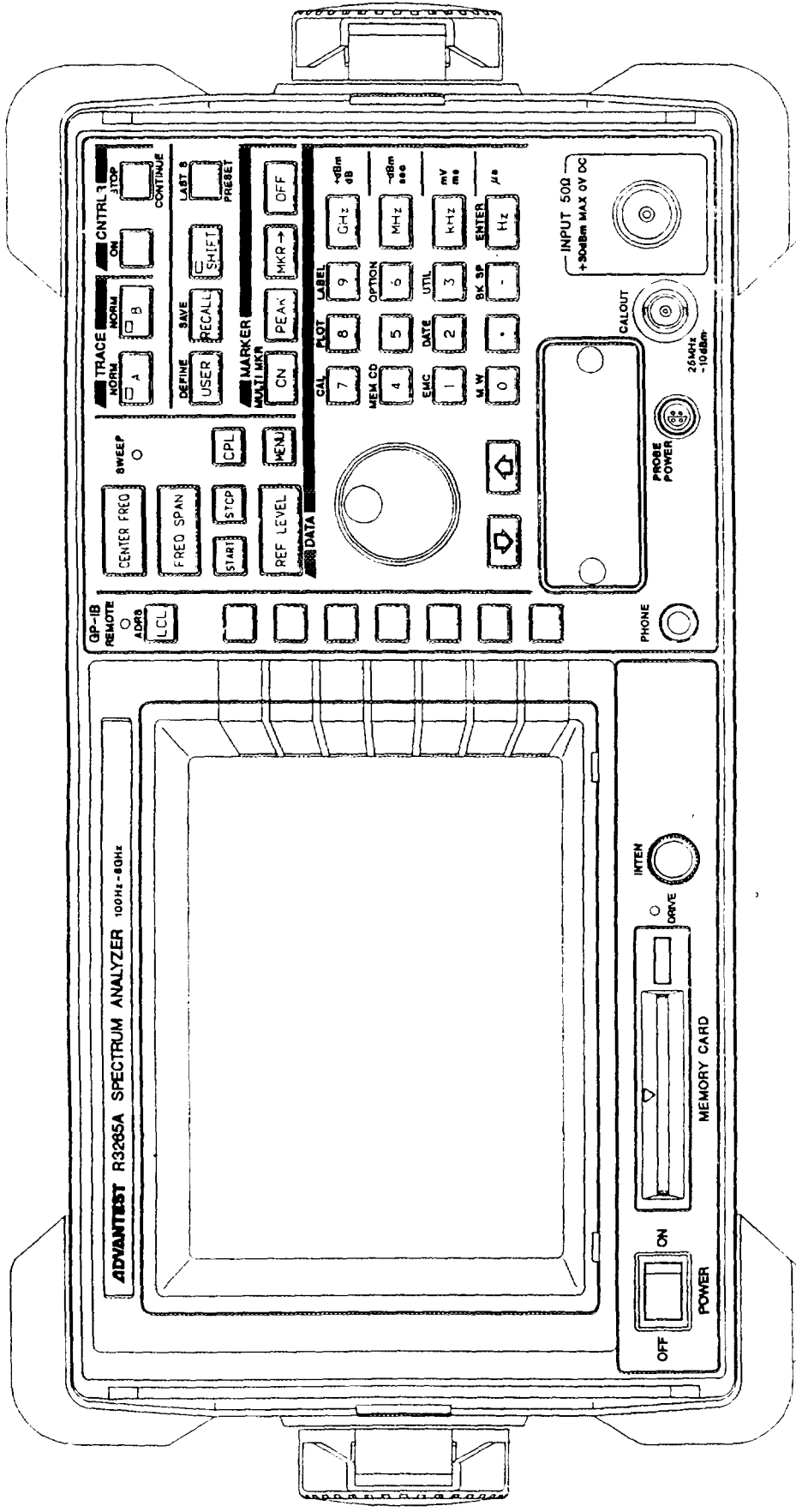

FRONT VIEW (R3265A)

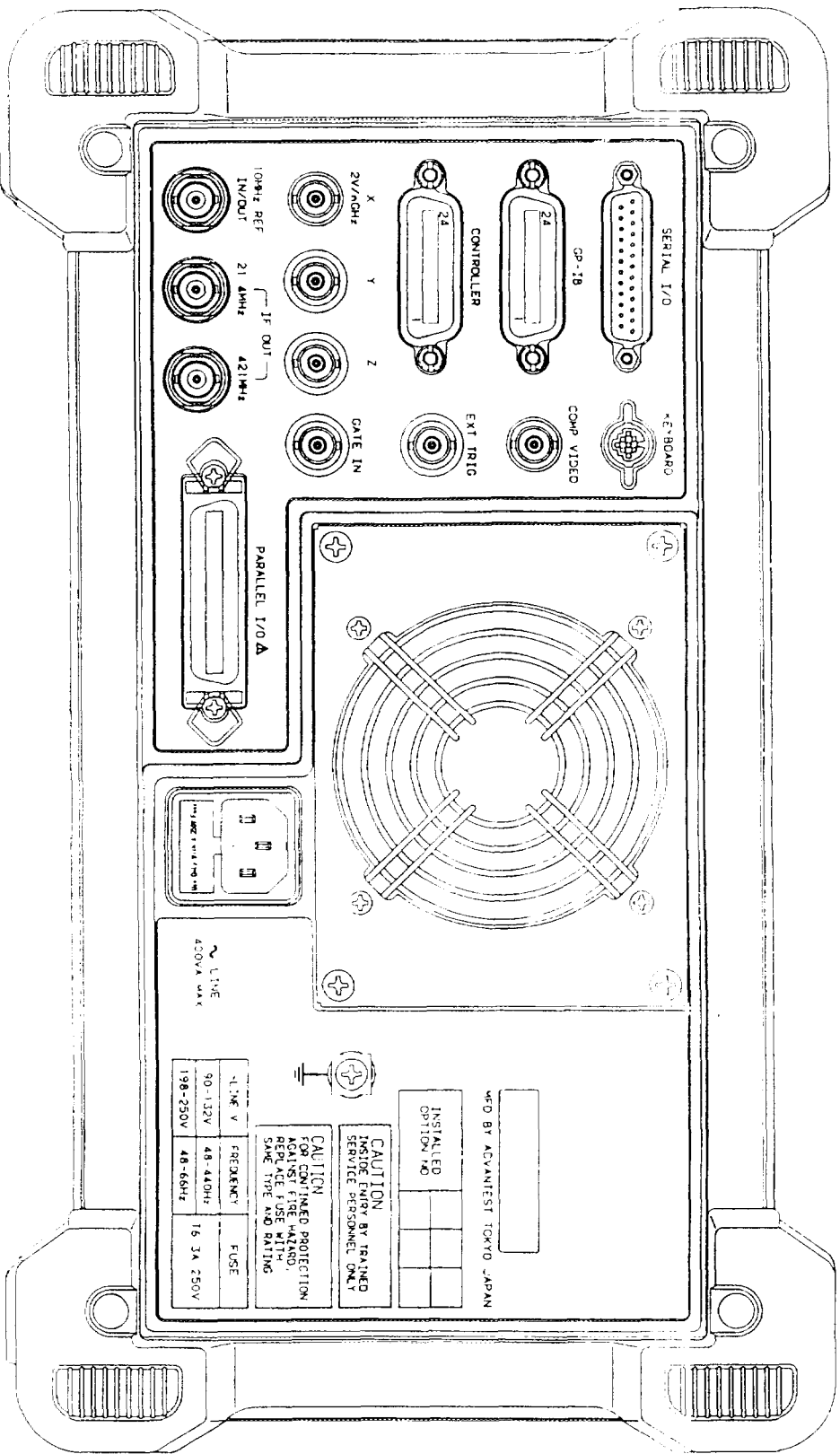

REAR VIEW (R3265A)

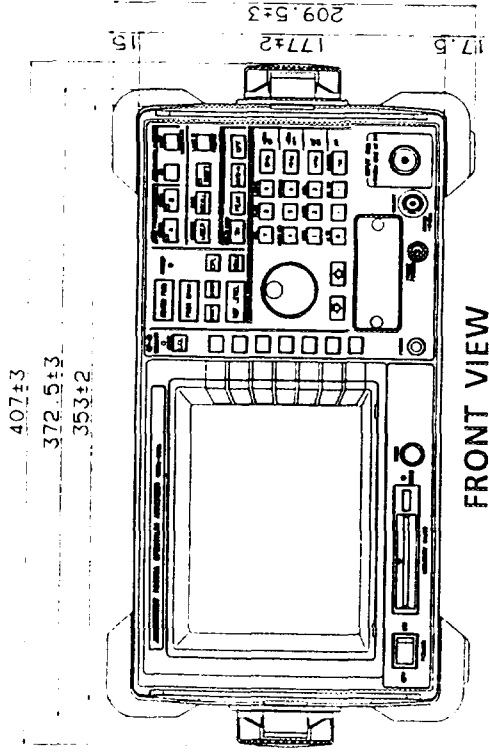

FRONT VIEW

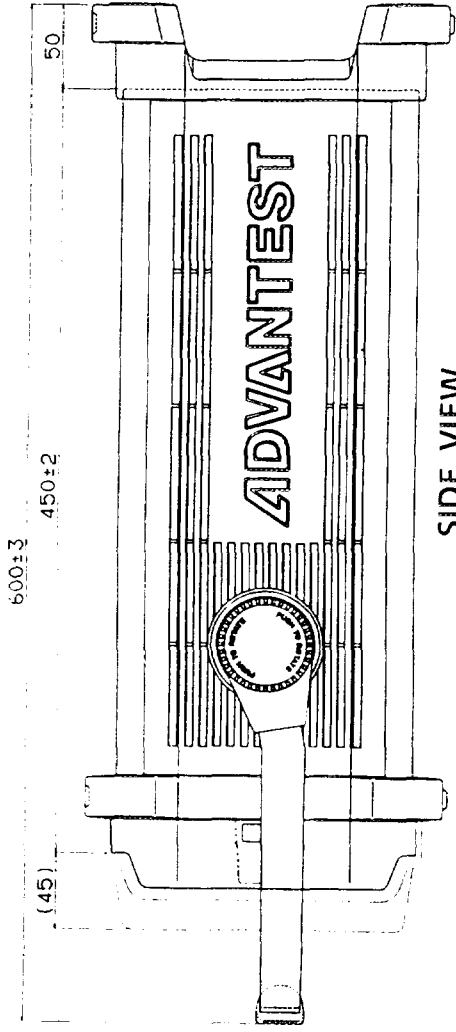

SIDE VIEW

Unit: mm

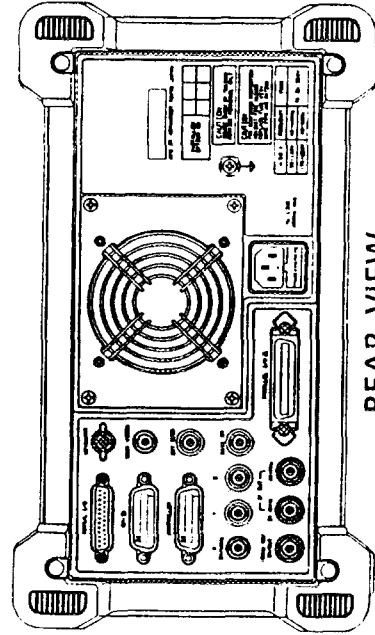

REAR VIEW

EXTERNAL VIEW (R3265A)

PART2

R3265A/3271A ● PERFORMANCE TEST
● ADJUSTMENT

PREFACE

The part 2. appends 4 chapter and 5 chapter of the R3265A/3271A maintenance manual for the calibration and the adjustment.

When you maintenance, refer to the R3265A/3271A maintenance manual.

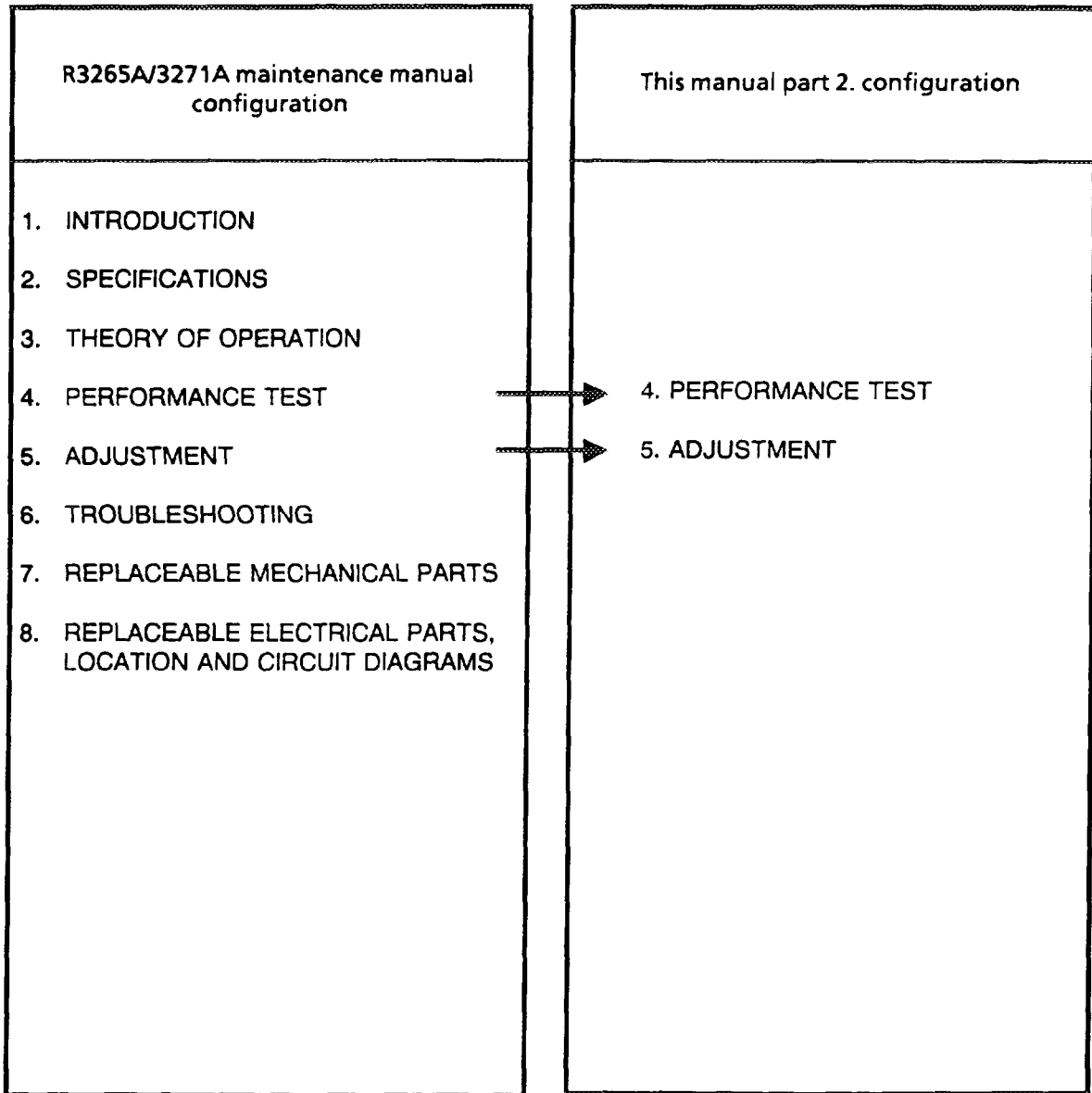

TABLE OF CONTENTS

4. PERFORMANCE TEST (CALIBRATION)	4-1
4.1 Introductory Description and UUT Performance Requirements	4-1
4.2 Measurement Standards and Support Test Equipment Performance Requirement	4-7
4.3 Preliminary Operations	4-10
4.4 Performance Test Process	4-11
4.4.1 Accuracy of Frequency Readout and Frequency Counter Marker ..	4-11
4.4.2 Frequency Reference Output Accuracy	4-14
4.4.3 Residual FM	4-16
4.4.4 Frequency Drift	4-19
4.4.5 Noise Sidebands	4-22
4.4.6 Frequency Span Accuracy	4-24
4.4.7 Resolution Bandwidth Accuracy and Selectivity	4-29
4.4.8 Resolution Bandwidth Switching Uncertainty	4-33
4.4.9 Displayed Average Noise Level	4-36
4.4.10 Gain Compression	4-43
4.4.11 Residual Response	4-48
4.4.12 Second Harmonic Distortion	4-51
4.4.13 Third Order Intermodulation Distortion	4-55
4.4.14 Image, Multiple and Out-of-Band Response	4-59
4.4.15 Frequency Response	4-66
4.4.16 IF Gain Uncertainty	4-78
4.4.17 Scale Fidelity	4-83
4.4.18 Input Attenuator Accuracy	4-90
4.4.19 Sweep Time Accuracy	4-94
4.4.20 Calibration Amplitude Accuracy	4-97
4.5 Checklist/Data Form	4-98
5. ADJUSTMENT	5-1
5.1 Measurement Standards and Support Test Equipment Performance Requirements	5-1
5.2 Preliminary Operations	5-4
5.3 Adjustment	5-5
5.3.1 A/D Adjustment	5-5
5.3.2 Log Amp Adjustment	5-11
5.3.3 Interface Filter Adjustment	5-19
5.3.4 IF Step Amp Adjustment	5-25
5.3.5 28.6 MHz Rejection Circuit Adjustment	5-28
5.3.6 YTO Adjustment	5-30

5.3.7 YTF Adjustment	5-32
5.3.8 Frequency Response Adjustment	5-37
5.3.9 Calibrator Amplitude Adjustment	5-45
5.3.10 10MHz Frequency Reference Adjustment	5-47
5.3.11 Frequency Span Adjustment	5-50
5.3.12 Sample Synthesizer Adjustment	5-54

LIST OF ILLUSTRATIONS

No.	Title	Page
4-1	Frequency Readout and Frequency Counter Marker Accuracy Test Setup	4-11
4-2	Frequency Reference Accuracy Test Setup	4-14
4-3	Residual FM Test Setup	4-16
4-4	Frequency Drift Test Setup	4-19
4-5	Noise Sidebands Test Setup	4-22
4-6	Frequency Span Accuracy Test Setup	4-24
4-7	Resolution Bandwidth Accuracy/Selectivity Setup	4-29
4-8	Resolution BW Switching Uncertainty Test Setup	4-33
4-9	Displayed Average Noise Test Setup	4-37
4-10	Gain Compression Test Setup	4-43
4-11	Second Harmonic Distortion Test Setup	4-51
4-12	Third Order Intermodulation (<300 MHz) Test Setup	4-55
4-13	Image, Multiple and Out-of-Band Response Test Setup	4-59
4-14	Frequency Response Test Setup	4-67
4-15	IF Gain Uncertainty Test Setup	4-78
4-16	Scale Fidelity Test Setup	4-83
4-17	Input Attenuator Switching Accuracy Test Setup	4-90
4-18	Sweep Time Accuracy Test Setup	4-94
4-19	Calibration Amplitude Accuracy Test Setup	4-97
5-1	Setup for Reference Voltage Adjustment	5-5
5-2	Adjustment Setup	5-6
5-3	Setup for Slope Detector Adjustment	5-9
5-4	21.4 MHz B.P.F. Adjustment Setup	5-11
5-5	Adjustment Setup	5-14
5-6	LC Filter Adjustment Setup	5-19
5-7	Resonator Filter Adjustment Setup	5-21
5-8	IF Step Amp Adjustment	5-25
5-9	28.6 MHz Rejection Circuit Adjustment	5-28
5-10	YTO Adjustment Setup	5-30
5-11	YTF Adjustment Setup	5-32
5-12	Frequency Response Adjustment Setup	5-37
5-13	Calibrator Amplitude Adjustment Setup	5-45
5-14	10 MHz Frequency Reference Adjustment Setup	5-47
5-15	10 MHz Reference Cristal Oscillator Adjustment	5-49
5-16	SPAN Adjustment Setup	5-50
5-17	Sampler Synthe Adjustment	5-54
5-18	Frequency Response Adjustment (2) Setup	5-56

LIST OF TABLES

No.	Title	Page
4-1	UUT Performance Requirements (1 of 5)	4-2
4-2	Measurement Standards (MS) Performance Requirements	4-8
4-3	Support Measuring & Test Equipment (M&TE) Performance Requirements	4-9
4-4	Frequency Readout Accuracy	4-13
4-5	Frequency Counter Marker Accuracy	4-13
4-6	Noise Sidebands	4-23
4-7	Frequency Span Accuracy	4-27
4-8	LOG Span Accuracy	4-28
4-9	Resolution Bandwidth Accuracy	4-31
4-10	Resolution Bandwidth Selectivity	4-32
4-11	Resolution BW Switching Uncertainty	4-35
4-12	Displayed Average Noise Level (R3265)	4-41
	Displayed Average Noise Level (R3271)	4-42
4-13	Gain Compression	4-47
4-14	Third Order Intermodulation Distortion	4-58
4-16	Image, Multiple and Out-of-Band Responses (R3271)	4-64
4-17	Image, Multiple and Out-of-Band Responses (R3265)	4-65
4-18	Frequency Response (R3265/3271 : 100 Hz to 3.6 GHz Band)	4-73
4-19	Frequency Response (R3265/3271 : 3.6 GHz to 7.5 GHz Band)	4-74
4-20	Frequency Response (R3265 : 7.5 GHz to 8 GHz Band) (R3271 : 7.5 GHz to 15.4 GHz Band)	4-75
4-21	Frequency Response (R3271 : 15.4 GHz to 23.3 GHz Band)	4-76
4-22	Frequency Response (R3271 : 23.3 GHz to 26.5 GHz Band)	4-77
4-23	IF Gain Error (RBW = 1 MHz, 1 dB/div.)	4-80
4-24	IF Gain Error (RBW = 3 kHz, 1 dB/div.)	4-81
4-25	IF Gain Error (RBW = 300 kHz, 0.5 dB/div.)	4-82
4-26	1 dB/div. Log Scale Fidelity (RBW = 1 MHz)	4-86
4-27	10 dB/div. Log Scale Fidelity (RBW = 3 kHz)	4-86
4-28	Linear Scale Fidelity (X1)	4-88
4-29	QP-mode Log Scale Fidelity	4-88
4-30	Input Attenuator Accuracy	4-93
4-31	Sweep Time Accuracy	4-96
4-32	Performance Test Record (1 of 12)	4-98
5-1	Measurement Standards (MS) Performance Requirements (1 of 2)	5-1
5-2	Support Measuring & Test Equipment (M&TE) Performance Requirements	5-3
5-3	Span Adjustment	5-52
5-4	LOG SPAN Adjustment	5-53

4. PERFORMANCE TEST (CALIBRATION)

4.1 Introductory Description and UUT Performance Requirements

This procedure describes the performance test of the spectrum analyzer R3265A/3271A.

The unit being test will be referred to herein as the UUT (Unit-Under-Test).

UUT Environmental range : TEMP. 20°C to 30°C RH 85% or less
UUT Warm-up/Stabilization period requirements : 60 minutes

Table 4-1 UUT Performance Requirements (1 of 5)

Unit-Under-Test (UUT) Parameter/Function	Performance Specifications	Test Method
1. Frequency Readout Accuracy and Frequency Counter Marker Accuracy.	Frequency Readout Accuracy: $< \pm [\text{Counter Frequency} \times \text{Frequency Reference Accuracy}] + (\text{Span} \times \text{Span Accuracy}) + (0.15 \times \text{RES.BW}) + 10 \text{ Hz}$ Span Accuracy: Span $> 2 \text{ MHz} \pm 3\%$ Span $\leq 2 \text{ MHz} \pm 5\%$ Marker Frequency Counter Accuracy: $< \pm [(\text{Marker Frequency} \times \text{Frequency Reference Accuracy}) + (5 \text{ Hz} \times N) + 1\text{LSD}]$	Signals are input from the SG where high-precision frequency standard is set as the reference frequency for measurement.
2. Frequency Reference Output Accuracy.	Frequency: $< 1 \times 10^{-7}/\text{year}$ $< 2 \times 10^{-8}/\text{day}$	The frequency of CAL OUT signal locked to the internal 10 MHz reference is measured with the counter.
3. Residual FM	Residual FM: $< 3 \text{ Hz} \times N_{p-p}/0.1 \text{ sec}$	Highly stabilized signals are input for measurement.
4. Frequency Drift	Frequency Drift: $2.5 \text{ kHz} \times \text{Sweep Time (min.)} \times N$ ($50 \text{ kHz} < \text{Span} \leq 2 \text{ MHz}$) $60 \text{ Hz} \times \text{Sweep Time (min.)} \times N$ ($\text{Span} \leq 50 \text{ kHz}$)	Highly stabilized signals are input for measurement.
5. Noise Sidebands	$f \leq 2.6 \text{ GHz}$: 1 kHz offset $< -100 \text{ dBc/Hz}$ 10 kHz offset $< -110 \text{ dBc/Hz}$ 20 kHz offset $< -110 \text{ dBc/Hz}$ 100 kHz offset $< -114 \text{ dBc/Hz}$ $f > 2.6 \text{ GHz}$: 1 kHz offset $< (-95 + 20 \log N) \text{ dBc/Hz}$ 10 kHz offset $< (-108 + 20 \log N) \text{ dBc/Hz}$ 20 kHz offset $< (-108 + 20 \log N) \text{ dBc/Hz}$ 100 kHz offset $< (-110 + 20 \log N) \text{ dBc/Hz}$	Good noise sideband signals are input for measurement.
6. Frequency Span Accuracy	Linear Span: $< \pm 3\%$ (Span $> 2 \text{ MHz}$) $< \pm 5\%$ (Span $\leq 2 \text{ MHz}$) Log Span: $\pm (10 + \text{Stop Frequency} \times 0.1\%)$	Signals at two frequencies according to each span are input to measure the difference between the frequencies.

Table 4-1 UUT Performance Requirements (2 of 5)

Unit-Under-Test (UUT) Parameter/Function	Performance Specifications	Test Method
7. Resolution Bandwidth Accuracy and Selectivity	<p>Range Accuracy:</p> <p>10 Hz to 3 MHz 1, 3, 10 sequence $\pm 15\%$ 100 Hz to 1 MHz $\pm 25\%$ 30 Hz (25°C $\pm 10^\circ\text{C}$), 3 MHz $\pm 50\%$ 10 Hz to 100 Hz nominal (digital IF)</p> <p>Selectivity (–60 dB/–3 dB):</p> <p>< 15:1 100 Hz to 3 MHz < 20:1 30 Hz 5:1 10 Hz to 100 Hz nominal (digital IF)</p> <p>Bandwidth (–6 dB):</p> <p>200 Hz, 9 kHz, 120 kHz Conformed to CISPR standard</p>	CAL OUT signals are input for measurement.
8. Resolution Bandwidth Switching Uncertainty	<p>100 Hz to 3 MHz RBW:</p> <p>< ± 0.3 dB (Reference to 300 kHz RBW)</p> <p>30 Hz RBW : < ± 1 dB (digital IF)</p> <p>10 Hz to 100 Hz : < ± 1.5 dB</p>	CAL OUT signals are input for measurement.
9. Displayed Average Noise Level	<p>(10 Hz res BW, 0 dB input atten, 1 Hz video filter)</p> <p>R3265A:</p> <p>– 100 dBm 1 kHz – 110 dBm 10 kHz – 111 dBm 100 kHz – 135 dBm 1 MHz – {140 – 1.55f(GHz)} dBm 10 MHz to 3.6 GHz – {145 – 1.55f(GHz)} dBm 10 MHz to 3.6 GHz (Low noise mode) – 135 dBm 3.5 GHz to 8 GHz</p> <p>R3271A:</p> <p>– 100 dBm 1 kHz – 110 dBm 10 kHz – 111 dBm 100 kHz – {135 – 1.55f(GHz)} dBm 1 MHz to 3.6 GHz – 130 dBm 3.5 GHz to 7.5 GHz – 123 dBm 7.4 GHz to 15.4 GHz – 116 dBm 15.2 GHz to 23.3 GHz – 110 dBm 23 GHz to 26.5 GHz</p>	No signal is input and average noise level at each frequency is measured.

Table 4-1 UUT Performance Requirements (3 of 5)

Unit-Under-Test (UUT) Parameter/Function	Performance Specifications	Test Method																											
10. Gain Compression (1 dB)	R3265A: -5 dBm mixer input level > 200 MHz -10 dBm mixer input level > 10 MHz R3271A: -5 dBm mixer input level > 10 MHz	Two signals are input simultaneously to measure the level at which one of the signals is lowered by 1 dB.																											
11. Residual Response	(no signal at input, 0 dB RF Attenuation) R3265A: <table border="1" data-bbox="500 625 906 730"> <tr> <td>< -100 dBm</td> <td>1 MHz</td> </tr> <tr> <td>< -90 dBm</td> <td>300 kHz</td> </tr> </table> R3271A: <table border="1" data-bbox="500 825 1101 930"> <tr> <td>< -100 dBm</td> <td>1 MHz to 3.6 GHz</td> </tr> <tr> <td>< -90 dBm</td> <td>300 kHz to 26.5 GHz</td> </tr> </table>	< -100 dBm	1 MHz	< -90 dBm	300 kHz	< -100 dBm	1 MHz to 3.6 GHz	< -90 dBm	300 kHz to 26.5 GHz	No signal is input and the test is terminated at 50 Ω.																			
< -100 dBm	1 MHz																												
< -90 dBm	300 kHz																												
< -100 dBm	1 MHz to 3.6 GHz																												
< -90 dBm	300 kHz to 26.5 GHz																												
12. Second Harmonic Distortion	<table border="1" data-bbox="467 951 1127 1434"> <thead> <tr> <th></th> <th>freq range</th> <th>mixer level</th> </tr> </thead> <tbody> <tr> <td colspan="3">R3265A:</td> </tr> <tr> <td>< -70 dBc</td> <td>100 MHz to 3.6 GHz</td> <td>-30 dBm</td> </tr> <tr> <td>< -60 dBc</td> <td>10 MHz to 3.6 GHz</td> <td>-30 dBm</td> </tr> <tr> <td>< -100 dBc</td> <td>> 3.5 GHz</td> <td>-10 dBm</td> </tr> <tr> <td colspan="3">R3271A:</td> </tr> <tr> <th></th> <th>freq range</th> <th>mixer level</th> </tr> <tr> <td>< -70 dBc</td> <td>10 MHz to 3.6 GHz</td> <td>-30 dBm</td> </tr> <tr> <td>< -100 dBc</td> <td>> 3.5 GHz</td> <td>-10 dBm</td> </tr> </tbody> </table>		freq range	mixer level	R3265A:			< -70 dBc	100 MHz to 3.6 GHz	-30 dBm	< -60 dBc	10 MHz to 3.6 GHz	-30 dBm	< -100 dBc	> 3.5 GHz	-10 dBm	R3271A:				freq range	mixer level	< -70 dBc	10 MHz to 3.6 GHz	-30 dBm	< -100 dBc	> 3.5 GHz	-10 dBm	The lowpass filter is connected to the SG output for measurement.
	freq range	mixer level																											
R3265A:																													
< -70 dBc	100 MHz to 3.6 GHz	-30 dBm																											
< -60 dBc	10 MHz to 3.6 GHz	-30 dBm																											
< -100 dBc	> 3.5 GHz	-10 dBm																											
R3271A:																													
	freq range	mixer level																											
< -70 dBc	10 MHz to 3.6 GHz	-30 dBm																											
< -100 dBc	> 3.5 GHz	-10 dBm																											

4.1 Introductory Description and UUT Performance Requirements

Table 4-1 UUT Performance Requirements (4 of 5)

Unit-Under-Test (UUT) Parameter/Function	Performance Specifications	Test Method		
13. Third Order Intermodulation Distortion	R3265A:	Two neighboring signals are input simultaneously for measurement.		
	freq range		mixer level	
	< -70 dBc		200 MHz to 3.6 GHz	-30 dBm
	< -60 dBc		10 MHz to 3.6 GHz	-30 dBm
	< -75 dBc		> 3.5 GHz	-30 dBm
	R3271A:		freq range	mixer level
	< -70 dBc		10 MHz to 3.6 GHz	-30 dBm
< -75 dBc	> 3.6 GHz	-30 dBm		
14. Image, Multiple, Out of Band Response	R3265A: < -70 dBc (10 MHz to 8 GHz)	Signals allowing image, multiple and out of band response as against the center frequency are input for measurement.		
	R3271A: < -70 dBc (10 MHz to 18 GHz) < -60 dBc (10 MHz to 23 GHz) < -50 dBc (10 MHz to 26.5 GHz)			
15. Frequency Response	10 dB input attenuation R3265A: ± 1.5 dB 100 Hz to 3.6 GHz ± 1.0 dB 50 MHz to 2.6 GHz ± 1.5 dB 3.5 GHz to 7.5 GHz ± 1.5 dB 7.4 GHz to 8 GHz Additional Uncertainty Due to Band Switching: ± 0.5 dB Frequency Response Referenced to CAL Signal: ± 5 dB 100 Hz to 8 GHz R3271A: ± 1.5 dB 100 Hz to 3.6 GHz ± 1.0 dB 50 MHz to 2.6 GHz ± 1.5 dB 3.5 GHz to 7.5 GHz ± 3.5 dB 7.4 GHz to 15.4 GHz ± 4.0 dB 15.4 GHz to 23.3 GHz ± 4.0 dB 23 GHz to 26.5 GHz Additional Uncertainty Due to Band Switching: ± 0.5 dB Frequency Response Referenced to CAL Signal: ± 5 dB 100 Hz to 26.5 GHz	The signal level of SG at a certain level on the screen is measured at each frequency with the power meter.		

Table 4-1 UUT Performance Requirements (5 of 5)

Unit-Under-Test (UUT) Parameter/Function	Performance Specifications	Test Method
16. IF Gain Uncertainty	(after automatic calibration) ± 0.5 dB 0 dBm to -50 dBm ± 0.7 dB 0 dBm to -80 dBm	The REF level is raised while lowering the signal level with the external attenuator to measure the error.
17. Scale Fidelity	Log: ± 0.2 dB/1 dB, ± 1 dB/10 dB, ± 1.5 dB/90 dB Linear: $\pm 5\%$ of reference level QP Mode Log: ± 1.0 dB/30 dB, ± 2 dB/40 dB, ± 1.0 dB/40 dB (25°C \pm 10°C)	Input signal is lowered with the external attenuator for measurement.
18. Input Attenuator Accuracy	(20 dB to 70 dB settings referenced to 10 dB) R3265A: ± 1.1 dB/10 dB step, 2.0 dB max, 100 Hz to 8 GHz R3271A: ± 1.1 dB/10 dB step, 2.0 dB max, 100 Hz to 12.4 GHz ± 1.3 dB/10 dB step, 2.5 dB max, 12.4 GHz to 18 GHz ± 1.8 dB/10 dB step, 3.5 dB max 18 GHz to 26.5 GHz	Signal at a frequency is input and measured with the internal attenuator.
19. Sweep Time Accuracy	Accuracy: $< \pm 3\%$	Square wave signals at a known frequency are input repeatedly according to each sweep time for sweep time measurement.
20. Calibration Amplitude Accuracy	Amplitude: -10 dBm ± 0.3 dB	CAL OUT signals are measured with the power meter.

4.2 Measurement Standards and Support Test Equipment Performance Requirement

4.2 Measurement Standards and Support Test Equipment Performance Requirement

Minimum-Use-Specifications (MUS) are the calculated minimum performance specifications criteria needed for the Measurement Standards (MS) and support M&TE to be used for the comparison measurements required in the Test Procedure (TP) process.

The MUS is developed through uncertainty analysis and is calculated through assignment of a defines and documented uncertainty/accuracy ratio or margin between the specified tolerances of the UUT and the capability (uncertainty specification) required of the measurement standards system. MUS is required to assist a measurement specialist in the evaluation of existing or selection of alternate measurement standards equipment.

The uncertainty/accuracy ratio applied in this TP is 10:1 and any exception to that is indicated in Section 4.1.

CAUTION

The instructions in this TP relate specifically to the equipment and conditions listed in Section 4.2. If other equipment is substituted, the information and instructions must be interpreted and revised accordingly.

MS and SM&TE Environmental Range : Temperature : 18°C to 28°C
: Relative Humidity : 30% to 70%

MS and SM&TE Warm-up/Stabilization Period Requirements : 60 minutes

4.2 Measurement Standards and Support Test Equipment Performance Requirement

Table 4-2 Measurement Standards (MS) Performance Requirements

Equipment Generic Name (Qty)	Minimum-Use-Specifications	Mfr., Model/Option Applicable
Frequency Standard	Output Frequency : 10 MHz Stability : 5×10^{-10} /day Output Impedance : about 50 Ω Output Voltage : 1 Vpp or more	TR3110
Synthesized Sweeper	Frequency Range : 10 MHz to 18 GHz Frequency Accuracy (CW): 3×10^{-8} /day Power Level Range : -15 dBm to +15 dBm	TR4515
Frequency Counter	Frequency Range : 10 Hz to 120 MHz Gate Time : 10s Number of Digits Displayed : 8 digits Input Voltage Range : 25 mVrms to 500 mVrms	TR5823
Frequency Synthesizer	Frequency Range : 10 MHz to 20 MHz Stability : 5×10^{-6} /year Power Level Range : -10 dBm to +13 dBm	HP3325
Synthesized Signal Generator	Frequency Range : 10 MHz to 4 GHz Residual SSB Phase Noise: 1 kHz offset < -115 dBc/Hz 10 kHz offset < -125 dBc/Hz 100 kHz offset < -130 dBc/Hz Power Level Range : -20 dBm to +10 dBm	R4262
Power Meter	Accuracy : ± 0.02 dB (dB Relative Mode)	HP436A
Power Sensor	Frequency Range : 50 MHz to 26.5 GHz Power Range : 1 μ W to 100 mW Maximum SWR : 1.25 (26.5 GHz)	HP 8485A
	Frequency Range : 10 MHz to 18 GHz Power Range : 1 μ W to 10 mW	HP8481A
Sweeper	Frequency Range : 10MHz to 26.5 GHz Power Range : -5 dBm to +10 dBm (at 3.6 GHz)	HP8350 + HP83595A
1 dB Step Attenuator	Frequency Range : DC to 18 GHz Attenuation Range : 12 dB	HP8494H
10 dB Step Attenuator	Frequency Range : DC to 18 GHz Attenuation Range : 70 dB	HP8495H
Attenuator Driver		HP11713A

4.2 Measurement Standards and Support Test Equipment Performance Requirement

Table 4-3 Support Measuring & Test Equipment (M&TE) Performance Requirements

Equipment Generic Name (Qty)	Minimum-Use-Specifications	Mfr., Model/Option Applicable
Adapter	Type N(m) to BNC(f)	Generic
	Type N(m) to SMA(f)	Generic
	SMA(m) to SMA(m)	50-673-0000-31 (Sealectro)
	Type N(f) to BNC(m)	Generic
50 Ω Termination	SMA	Generic
20dB Fixed, 3dB Fixed Attenuator	Connector : SMA(m), SMA(f)	Generic
Power Splitter	Frequency Range : 10 MHz to 26.5 GHz Insertion Loss : 6 dB (nominal)	Model 1579 (Weinschel)
Low-pass Filter	Cutoff Frequency : 2.2 GHz Rejection at 3 GHz : > 40 dB Rejection at 3.8 GHz: > 80 dB	
Power Divider	Frequency Range : 10 MHz to 300 MHz Isolation : > 20 dB	H-8-4 (ANZAC)
	Frequency Range : 2 GHz to 4 GHz Isolation : > 20 dB	4313-2 (NARDA)
Cable	Frequency Range : DC to 26.5 GHz Maximum SWR : < 1.45 GHz at 26.5 GHz Length : about 70 cm Connector : SMA(m) both ends	A01002
	Length : 150 cm Connector : BNC(m) both ends	MI-09
	Length : 10 cm Connector : BNC(m) both ends	MC-61

4.3 Preliminary Operations

WARNING

Always make sure spectrum analyzer's power supply cord is plugged into a 3-hole grounded outlet or 2-hole outlet with grounded adapter. You can be fatally shocked if you fail to follow this rule.

Do not touch live circuits when calibrating instrument.

- (1) Review this entire procedure before starting calibration procedure.
- (2) Always confirm that the POWER switch is OFF before connecting the power cable to the AC line.

4.4 Performance Test Process

4.4.1 Accuracy of Frequency Readout and Frequency Counter Marker

- SPECIFICATION

Frequency Readout Accuracy < $\pm [(\text{Center Frequency} \times \text{Frequency Reference Accuracy}) + (\text{Span} \times \text{Span Accuracy}) + (0.15 \times \text{RES.BW}) + 10 \text{ Hz}]$

Span Accuracy: Span > 2MHz $\pm 3\%$
 Span \leq 2MHz $\pm 5\%$

Marker Frequency Counter Accuracy < $\pm [(\text{Marker Freq.} \times \text{Freq. Reference Accuracy}) + (5 \text{ Hz} \times N) + 1 \text{ LSD}]$

- RELATED ADJUSTMENT

YTO Adjustment

10 MHz Frequency Reference Adjustment

- DESCRIPTION

The accuracy of the R3265A/3271A frequency readout and frequency counter marker is tested with an input signal of known frequency.

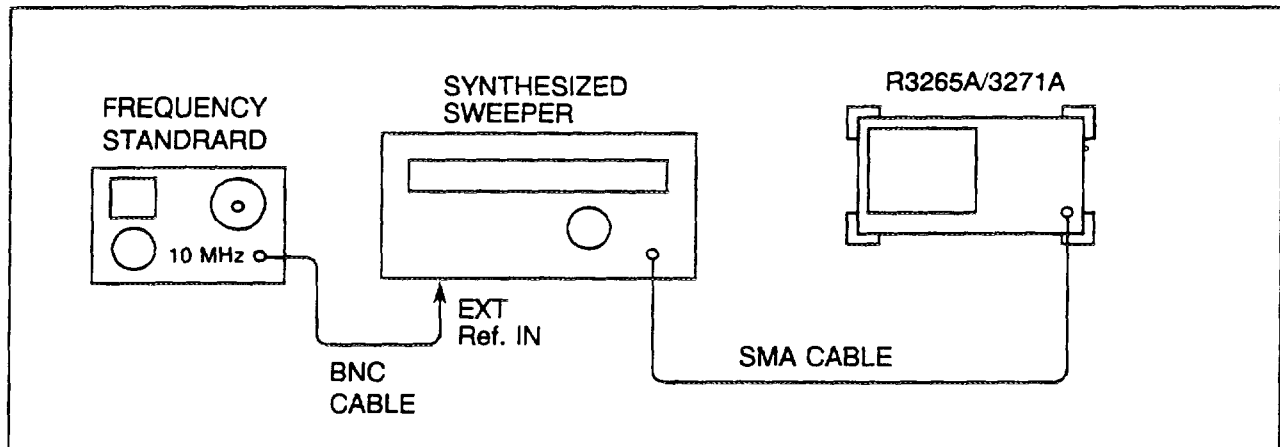

Figure 4-1 Frequency Readout and Frequency Counter Marker Accuracy Test Setup

- EQUIPMENT

Frequency Standard	TR3110
Synthesized Sweeper	TR4515

Cables:

SMA, 70 cm	A01002
BNC, 150 cm	MI-09

- PROCEDURE

- (1) Connect the equipment as shown in Figure 4-1

[Frequency Readout Accuracy]

- (2) Press the INSTRUMENT key on the TR4515. Set the TR4515 controls as follows:

CW	2 GMz
Power Level	- 10 dBm
Frequency Reference	EXT (Rear Panel)

- (3) On the R3265A/3271A, press the key and set the controls as follows:

Center Freq	2 GHz
Span	1 MHz

- (4) On the R3265A/3271A, press the key. Record the MKR frequency on Table 4-4 as the Actual Marker Reading. The reading should be within the limits shown.
- (5) Repeat step (4) for all the frequency and span combinations listed in Table 4-4. Peak the R3265A/3271A preselector for and set the Analyzer and the TR4515's key to frequencies of 5 GHz and above.

[Frequency Counter Marker Accuracy]

- (6) Set the key of the R3265A/3271A to 1 MHz.

Press the MARKER key to and .

- (7) Key in the TR4515 frequencies and the R3265A/R3271A center as indicated in Table 4-5. For each pair of settings, press the key and record the MKR frequency at each point in Table 4-5.
The marker readings should be within the limits shown.

Table 4-4 Frequency Readout Accuracy

TR4515 Frequency (GHz)	R3265A/3271A		Marker Reading		
	Span	Center Frequency	Min. (GHz)	Actual (GHz)	Max. (GHz)
2	1 MHz	2 GHz	1.999948		2.000051
2	10 MHz	2 GHz	1.99968		2.00031
2	20 MHz	2 GHz	1.99935		2.00064
2	50 MHz	2 GHz	1.99845		2.00154
2	100 MHz	2 GHz	1.9968		2.0031
2	2 GHz	2 GHz	1.939		2.060
5	1 MHz	5 GHz	4.999947		5.000052
5	10 MHz	5 GHz	4.99968		5.00031
5	20 MHz	5 GHz	4.99935		5.00064
5	50 MHz	5 GHz	4.99845		5.00154
5	100 MHz	5 GHz	4.9968		5.0031
5	2 GHz	5 GHz	4.939		5.060
< R3271A ONLY >					
11	1 MHz	11 GHz	10.999947		11.000052
11	10 MHz	11 GHz	10.99968		11.00031
11	20 MHz	11 GHz	10.99935		11.00064
11	50 MHz	11 GHz	10.99845		11.00154
11	100 MHz	11 GHz	10.9968		11.0031
11	2 GHz	11 GHz	10.939		11.060
18	1 MHz	18 GHz	17.999946		18.000053
18	10 MHz	18 GHz	17.99968		18.00031
18	20 MHz	18 GHz	17.99935		18.00064
18	50 MHz	18 GHz	17.99845		18.00154
18	100 MHz	18 GHz	17.9968		18.0031
18	2 GHz	18 GHz	17.939		18.060

Table 4-5 Frequency Counter Marker Accuracy

TR4515 Frequency (GHz)	R3265A/ 3271A Center Frequency (GHz)	Marker Frequency		
		Min.(GHz)	Actual(GHz)	Max.(GHz)
2	2	1.999999794		2.000000206
5	5	4.999999494		5.000000506
< R3271A ONLY >				
11	11	10.999998889		11.000001111
18	18	17.999998184		18.000001816

4.4.2 Frequency Reference Output Accuracy

- SPECIFICATION

Frequency: $< 1 \times 10^{-7}/\text{year}$, $< 2 \times 10^{-8}/\text{day}$

- RELATED ADJUSTMENT

Frequency Reference Adjustment

- DESCRIPTION

The 10 MHz reference signal is measured for frequency accuracy by measuring the frequency of the 25 MHz CAL OUTPUT signal. The CAL OUTPUT signal is referenced to the 10 MHz reference.

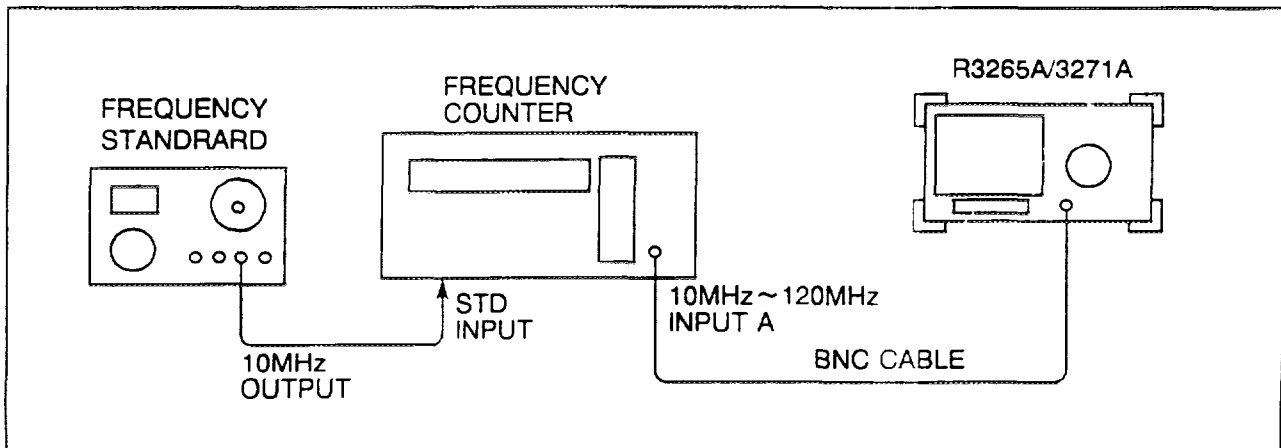

Figure 4-2 Frequency Reference Accuracy Test Setup

- EQUIPMENT

Frequency Counter	TR5823
Frequency Standard	TR3110

Cables:

BNC, 150 cm (2 required)	MI-09
--------------------------------	-------

● PROCEDURE

- (1) Connect the equipment as shown in Figure 4-2.
- (2) Set the TR5823 controls as follows:

FREQUENCY STD SWITCH (Rear Panel)	EXT
INPUT CHANNEL	INPUT A
GATE TIME	10 sec

- (3) Press the PRESET key on the R3265A/3271A.

CAUTION

Before starting this measurement, perform warm-up operation of the R3265A/3271A for more than 30 minutes. If the frequency reference of the R3265A/3271A is set to EXT, set it to INT or perform 15-minute warm-up operation after instrument preset.

- (4) Wait for the frequency counter to settle down.
- (5) Read the frequency counter display. The frequency should be within the following limits:

$$(2)^*4.9999975 \leq \text{_____} \leq (2)^*5.0000025$$

*: The counter can display only eight digits.

4.4.3 Residual FM

- SPECIFICATION

Residual FM: $< 3 \text{ Hz} \times \text{Np-p}/0.1 \text{ sec}$

- RELATED ADJUSTMENT

There is no related adjustment procedure for this performance test.

- DESCRIPTION

The Residual FM Test measures the short-term stability of the spectrum analyzer's LO system. A stable signal is applied to the input. In zero span, the signal is slope detected on the IF bandwidth filter skirt. Any instability in the LO system transfers to the IF signal in the mixing process. The test determines the slope of the IF filter in Hz/dB and then measures the signal amplitude variation caused by the residual FM. Multiplying these two values gives the residual FM in Hz.

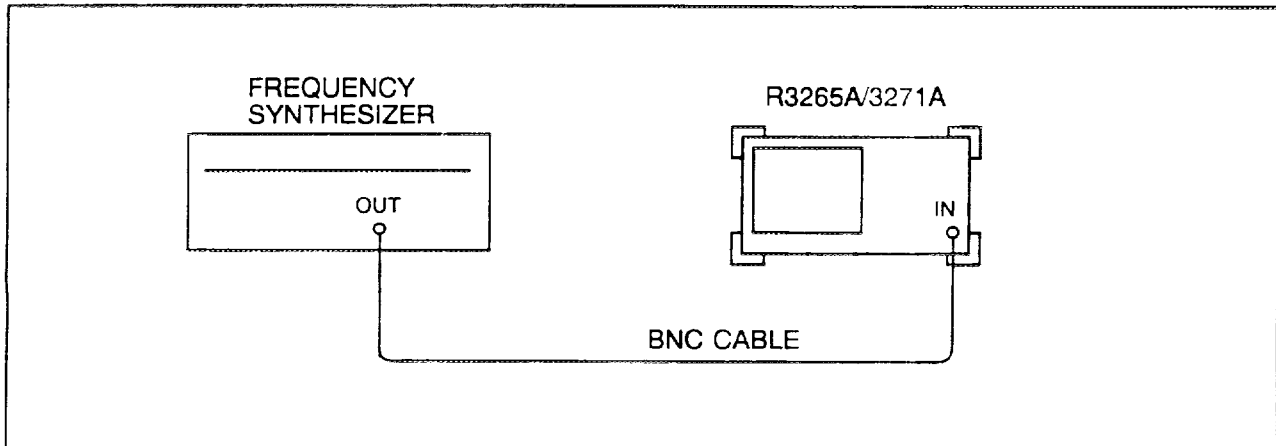

Figure 4-3 Residual FM Test Setup

- EQUIPMENT

Frequency Synthesizer HP3325

Cable:

BNC, 150 cm MI-09

- PROCEDURE

[Determining the IF Filter Slope]

- Connect the equipment as shown in Figure 4-3.
- Set the Frequency Synthesizer controls as follows:

FREQ	10 MHz
AMPTD	-10 dBn
FUNCTION	~ key

- On the R3265A/3271A, press the **PRESET** key and set the **CENTER FREQ** to 10 MHz, **FREQ SPAN** to 100kHz.

Press the **CPL** key and **NEXT MENU**, then press **DIGITAL IF 1/2/OFF** twice to set the Digital IF to "OFF".

Press the **PEAK** key, marker **ON** key, **SIG TRK ON/OFF** to set the signal track to "ON".

Press the **FREQ SPAN** key, then press **↓** six times to set the SPAN to 1kHz.

Set the **RBW** to 30 Hz.

Press the **MARKER ON** key, **SIG TRK ON/OFF** to set the signal track to "OFF".

Set the **REF LEVEL** -5 dBm and **dB/div** to 1 dB, and set **FREQ SPAN** to 200 Hz.

Press the **PEAK** key, **MKR→** key, **MKR→REF** and **PEAK MKR→ MKR→REF**.

Press the **MENU** key, **SWEEP MODE** and **SINGLE SWP**.

Press **ON** **△ MKR**.

- Rotate the data entry knob clockwise until **MKR** reads $-3 \text{ dB} \pm 0.1 \text{ dB}$.
Press **△ MKR**. Rotate the data entry knob clockwise until **MKR** read $-6 \text{ dB} \pm 0.1 \text{ dB}$.
- Divide the \triangle **MKR** frequency by the \triangle **MKR** amplitude to obtain the slope of the RBW filter. For example, if the \triangle **MKR** frequency is 14 Hz and the \triangle **MKR** amplitude is 6.05 dB, the slope is 2.3 Hz/dB.

Record the result below:

Slope _____ Hz/dB

[Measuring the Residual FM]

- (6) Press the MARKER OFF key, the MENU key, SWEEP MODE and CONT SWP .
Set FREQ SPAN to 0 Hz.

Set the SWEEP to 100 ms.

- (7) Press the CENTER FREQ key. Rotate the data entry knob clockwise to place the displayed trace about six divisions below the reference level.

Press the MENU key, SWEEP MODE and SINGLE SWP .

Press the PEAK key, MARKER ON key, MKR and PEAK key MIN .

- (8) Read the MKR amplitude, take its absolute value, and record the result as the deviation.

Deviation: _____dB

- (9) Calculate the residual FM by multiplying the slope recorded before by the deviation.
Record the result below.

The residual FM should be less the 3 Hz.

Residual FM: _____Hz

4.4.4 Frequency Drift

- SPECIFICATION

$$\text{Frequency Drift} \begin{cases} 2.5 \text{ kHz} \times \text{sweep time (min)} \times N & (50 \text{ kHz} < \text{span} \leq 2 \text{ MHz}) \\ 60 \text{ Hz} \times \text{sweep time (min)} \times N & (\text{span} \leq 50 \text{ kHz}) \end{cases}$$

- RELATED ADJUSTMENT

There is no related adjustment procedure for this performance test.

- DESCRIPTION

In the frequency drift test, drift of the spectrum analyzer's LO system is measured when the sweep time is long. Drifts are measured for two spans by inputting highly-stabilized signal.

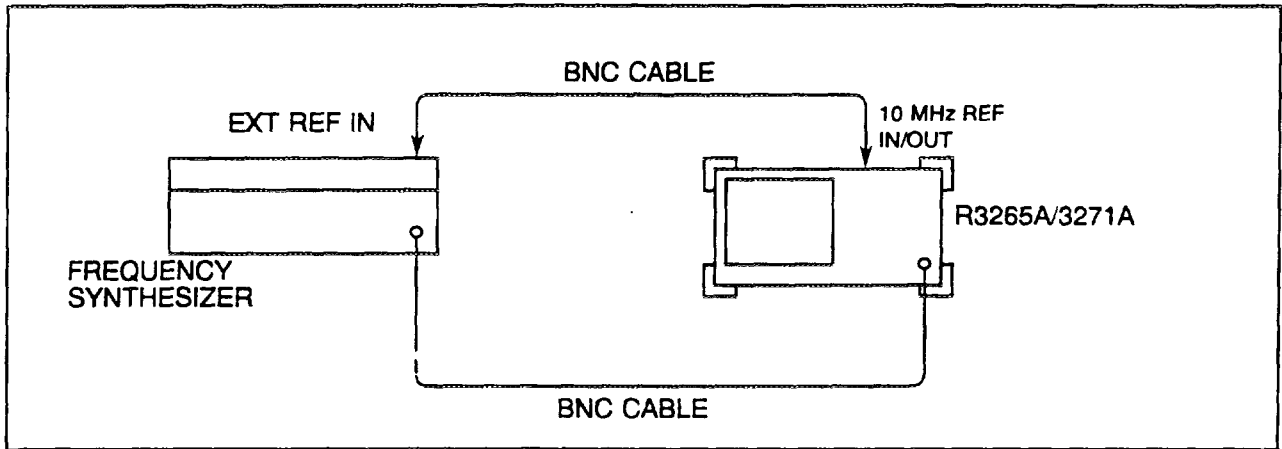

Figure 4-4 Frequency Drift Test Setup

- EQUIPMENT

- Frequency Synthesizer HP3325
- Cable: BNC 150 cm (2 required) MI-09
- Adapter: Type (N) to BNC

● PROCEDURE

(1) Connect the equipment as shown in Figure 4-4.

(2) On the HP3325, set the controls as follows:

FREQ 10 MHz
 AMPTD -8 dBm
 FUNCTION ~ key

(3) On the R3265A/3271A, press **PRESET** and set the controls as follows:

CENTER FREQ 10 MHz
 SPAN 50.1 kHz
 dB/div 2 dB/div
 SWP 1 sec

(4) On the R3265A/3271A, press **CENTER FREQ**, **↓**, **↓**, **↓** and the signal on the screen moves to the second division from the right. Wait for sweep to be performed three times or more.

(5) On the R3265A/3271A, press **A** **VIEW A** and **B** **WRITE B**.
 Set the sweep time to 80 sec.

Press **MENU** **SWEEP MODE** **SINGLE SWP** **RESET SWP**.

Wait for the sweep to be completed (until the sweep indicator goes off).

(6) On the R3265A/3271A, press **PEAK**, **MARKER**, **ON**, **MKR**, **A** and **PEAK**.

(7) Read the MKR frequency and record this as the frequency drift.

It should be less than 2.5 kHz.

Frequency Drift: _____ Hz

(8) On the R3265A/3271A, press **MENU**, **SWEEP MODE**, **CONT SWP** and **MARKER OFF**.

Press **A** **WRITE A**, **B** **BLANK B** and **CPL**, **SWP**, **AUTO**, **NEXT MENU**, **DIGITAL IF 1/2/OFF**, **DIGITAL IF 1/2/OFF** to set to the DIGITAL IF to "OFF".

Set the R3265A/3271A as follows:

Center Freq	10 MHz
Span	200 Hz
RBW	30 Hz
SWP	5 sec

Wait for sweep to be performed three times or more.

(9) Repeat (4) through (6).

(10) Read the MKR frequency and record this as the frequency drift.

It should be less than 60 Hz.

Frequency Drift: _____ Hz

4.4.5 Noise Sidebands

- SPECIFICATION

Noise Sidebands:

Offset	$f \leq 2.6$ GHz	$f > 2.6$ GHz
1 kHz	< -100 dBc/Hz	$< (-95 + 20 \log N)$ dBc/Hz
10 kHz	< -110 dBc/Hz	$< (-108 + 20 \log N)$ dBc/Hz
100 kHz	< -114 dBc/Hz	$< (-110 + 20 \log N)$ dBc/Hz

- RELATED ADJUSTMENT

There is no related adjustment procedure for this performance test.

- DESCRIPTION

The noise sidebands of a 2.6 GHz and 3.7 GHz, -10 dBm, signal are measured at an offset of 1 kHz, 10 kHz and 100 kHz from the carrier.

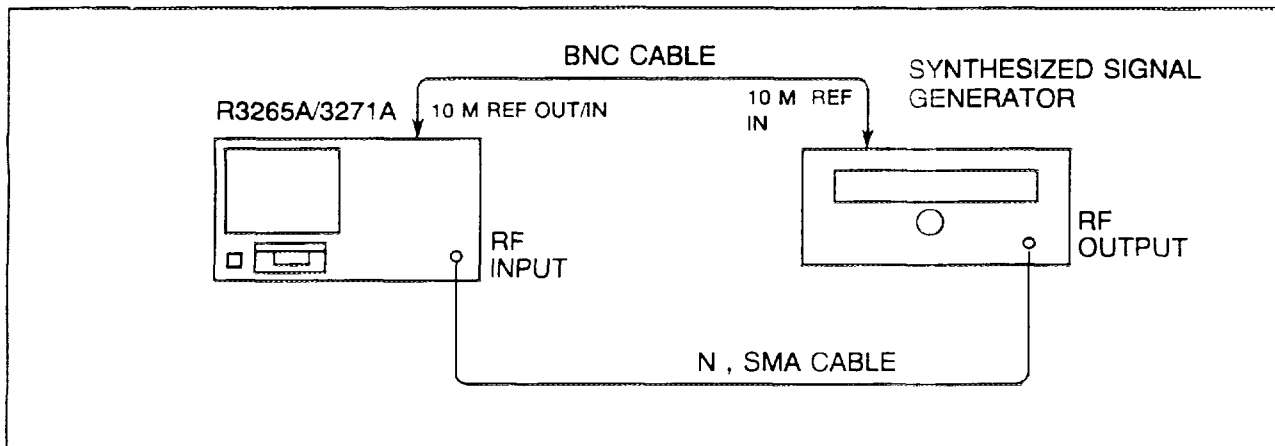

Figure 4-5 Noise Sidebands Test Setup

- EQUIPMENT: Synthesized Signal Generator

Critical Specifications for Equipment Substitution	Recommended model
Frequency Range = 10 MHz to 4 GHz Residual SSB Phase Noise at 1 kHz offset < -115 dBc/Hz 10 kHz offset < -125 dBc/Hz 100 kHz offset < -130 dBc/Hz	R4262

● PROCEDURE

- (1) Connect the equipment as shown in Figure 4-5.
- (2) Set the Signal Generator controls as follows:

Frequency 2.6 GHz & 3.7 GHz
 CW Output -5 dBm

- (3) Press the PRESET key on the R3265A/3271A. Press the CPL key and NEXT MENU, then press DIGITAL 1/2/OFF twice, to set the Digital IF to "OFF".
 Set CENTER FREQ to 2.6GHz.

Since the measurement is made for each of 1 kHz, 10 kHz and 100 kHz offset frequency, set the span frequency to 2.5 times each offset frequency, or 2.5 kHz, 25 kHz and 250 kHz. Keep other settings unchanged.

- (4) Operate keys on the R3265A/3271A as follows to measure noise sidebands of each offset frequency. The measurement procedure for 100 kHz offset frequency is explained here, and the procedure is applicable for 10 kHz and 1 kHz offset frequency.

Set the span corresponding to offset.

Press the PEAK key and the MKR→ key MKR→REF.
 Press the PEAK key and the MARKER ON key NOISE/XHz and dBc/Hz.
 Press 1 0 0 kHz to set each offset frequency.

Press the reference level by 20 dB and perform averaging for about 20 samples. After averaging, read the marker level and write it down in Table 4-6.

Also, measure noise sidebands with the center frequency at 3.7 GHz, and Table 4-6 is completed.

Table 4-6 Noise Sidebands

Offset (kHz)	CF 2.6 GHz		CF 3.7 GHz	
	Actual (dBc/Hz)	Max. (dBc/Hz)	Actual (dBc/Hz)	Max. (dBc/Hz)
1		-100		-95
10		-110		-108
100		-114		-110

4.4.6 Frequency Span Accuracy

- SPECIFICATION
 - < $\pm 3\%$ of actual frequency separation (SPAN > 2 MHz)
 - < $\pm 5\%$ of actual frequency separation (SPAN \leq 2 MHz)
 - < $\pm (10\%$ of actual frequency + 0.1% of Stop frequency): LOG Span Accuracy
- RELATED ADJUSTMENT
 - Span adjustment.
- DESCRIPTION

Set the signal frequency twice with the synthesized sweeper and measure the difference between signal frequencies with the analyzer.

Check the span accuracy using the signal frequency difference measured with the Δ MARKER function.

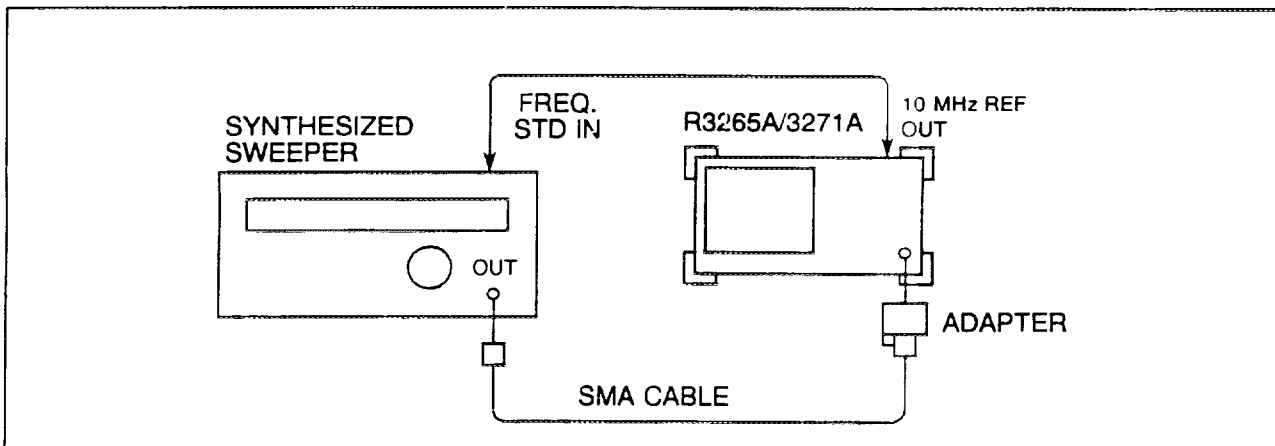

Figure 4-6 Frequency Span Accuracy Test Setup

- EQUIPMENT
 - Synthesized Sweeper TR4515
 - Cables:
 - SMA, 70 cm A01002
 - BNC, 150 cm MI-09

● PROCEDURE

- (1) Connect the equipment as shown in Figure 4-6.
- (2) Set the TR4515 controls as follows:

CW 1.999992 GHz
 Output Power -5 dBm
 Frequency STD Switch (Rear Panel) EXT

- (3) On the R3265A/3271A, press the **PRESET** key and set the R3265A/3271A controls as follows:

Center Freq 2 GHz
 Span 20 kHz

- (4) On the R3265A/3271A, press the **MENU** key, **SWEEP MODE**, **SINGLE SWP**, **SINGLE SWP**, the **PEAK** key and the **MARKER ON** key, **MARKER**.

- (5) Set the TR4515 controls as follows:

CW 2.000008 GHz

- (6) On the R3265A/3271A, press the **MENU** key, **SWEEP MODE**, **SINGLE SWP**, **SINGLE SWP** and the **PEAK** key.

Record the **MARKER** frequency reading as the Actual **MARKER** Reading in Table 4-7.

The reading should be within the limits shown.

- (7) Set the frequency of the TR4515, the center frequency and span of the R3265A/3271A as shown in Table 4-7, and repeat steps (5) through (7).

(LOG Span Accuracy)

- (8) On the R3265A/3271A, press the **PRESET** key and the **FREQ SPAN** key, **LOG SPAN**.

(9) Set the R3265A/3271A controls as follows:

Start frequency 100 MHz
 Stop frequency 1 GHz

(10) Set the TR4515 controls as follows:

CW 200 MHz

(11) On the R3265A/3271A, press the **MENU** key, **SWEEP MODE**, **SINGLE SWP**, **SINGLE SWP** and the **PEAK** key.

Record the MARKER frequency in Table 4-8 as the Actual Marker Reading. The reading should be within the limits shown.

(12) Set the frequency of the TR4515, the start and stop frequency of the R3265A/3271A as shown in Table 4-8, and repeat steps (10) through (12).

Table 4-7 Frequency Span Accuracy

TR4515 1st Frequency	TR4515 2nd Frequency	R3265A/R3271A		Δ Marker Reading		
		Center Frequency	Span Setting	Min.	Actual	Max.
1.999992 GHz	2.000008 GHz	2 GHz	20 kHz	15.2 kHz		16.8 kHz
1.999980 GHz	2.000020 GHz	2 GHz	50 kHz	38 kHz		42 kHz
1.999840 GHz	2.000160 GHz	2 GHz	400 kHz	304 kHz		336 kHz
1.9992 GHz	2.0008 GHz	2 GHz	2 MHz	1.52 MHz		1.68 MHz
1.9992 GHz	2.0008 GHz	2 GHz	2.01 MHz	1.552 MHz		1.648 MHz
1.998 GHz	2.002 GHz	2 GHz	5 MHz	3.88 MHz		4.12 MHz
1.996 GHz	2.004 GHz	2 GHz	10 MHz	7.76 MHz		8.24 MHz
1.992 GHz	2.008 GHz	2 GHz	20 MHz	15.52 MHz		16.48 MHz
1.98 GHz	2.02 GHz	2 GHz	50 MHz	38.8 MHz		41.2 MHz
1.96 GHz	2.04 GHz	2 GHz	100 MHz	77.6 MHz		82.4 MHz
1.92 GHz	2.08 GHz	2 GHz	200 MHz	155.2 MHz		164.8 MHz
1.8 GHz	2.2 GHz	2 GHz	500 MHz	388 MHz		412 MHz
1.6 GHz	2.4 GHz	2 GHz	1 GHz	776 MHz		824 MHz
1.2 GHz	2.8 GHz	2 GHz	2 GHz	1.552 GHz		1.648 GHz
2.9 GHz	6.1 GHz	4.5 GHz	4 GHz	3.104 GHz		3.296 GHz
1.3 GHz	7.7 GHz	4.5 GHz	8 GHz	6.208 GHz		6.592 GHz
< R3271A ONLY >						
9.996 GHz	10.004 GHz	10 GHz	10 MHz	7.76 MHz		8.24 MHz
9.96 GHz	10.04 GHz	10 GHz	100 MHz	77.6 MHz		82.4 MHz
9.6 GHz	10.4 GHz	10 GHz	1 GHz	776 MHz		824 MHz
9.2 GHz	10.8 GHz	10 GHz	2 GHz	1.552 GHz		1.648 GHz
16.996 GHz	17.004 GHz	17 GHz	10 MHz	7.76 MHz		8.24 MHz
16.96 GHz	17.04 GHz	17 GHz	100 MHz	77.6 MHz		82.4 MHz
16.6 GHz	17.4 GHz	17 GHz	1 GHz	776 MHz		824 MHz
16.2 GHz	17.8 GHz	17 GHz	2 GHz	1.552 GHz		1.648 GHz
8 GHz	12 GHz	10 GHz	5 GHz	3.88 GHz		4.12 GHz
6 GHz	14 GHz	10 GHz	10 GHz	7.76 GHz		8.24 GHz
2 GHz	18 GHz	10 GHz	19 GHz	15.52 GHz		16.48 GHz

Table 4-8 LOG Span Accuracy

TR4515 Frequency	R3265A/R3271A		Marker Reading		
	Start Frequency	Stop Frequency	Min.	Actual	Max.
200 MHz	100 MHz	1 GHz	179MHz		221 MHz
500 MHz	100 MHz	1 GHz	449 MHz		551 MHz
800 MHz	100 MHz	1 GHz	719 MHz		881 MHz
20 MHz	10 MHz	1 GHz	17 MHz		23 MHz
50 MHz	10 MHz	1 GHz	44 MHz		56 MHz
80 MHz	10 MHz	1 GHz	71 MHz		89 MHz
100 MHz	10 MHz	1 GHz	89 MHz		111 MHz
200 MHz	10 MHz	1 GHz	179 MHz		221 MHz
500 MHz	10 MHz	1 GHz	449 MHz		551 MHz
800 MHz	10 MHz	1 GHz	719 MHz		881 MHz
10 MHz	1 MHz	1 GHz	8 MHz		12 MHz
20 MHz	1 MHz	1 GHz	17 MHz		23 MHz
50 MHz	1 MHz	1 GHz	44 MHz		56 MHz
80 MHz	1 MHz	1 GHz	71 MHz		89 MHz
100 MHz	1 MHz	1 GHz	89 MHz		111 MHz
200 MHz	1 MHz	1 GHz	179 MHz		221 MHz
500 MHz	1 MHz	1 GHz	449 MHz		551 MHz
800 MHz	1 MHz	1 GHz	719 MHz		881 MHz

4.4.7 Resolution Bandwidth Accuracy and Selectivity

- SPECIFICATION

Range: 10 Hz to 3 MHz; 1, 3, 10 Sequence

Accuracy: $\pm 50\%$ (Resolution Bandwidth 10 Hz to 100 Hz, Digital IF)
 $\pm 15\%$ (Resolution Bandwidth 10 Hz to 1 MHz)
 $\pm 25\%$ (Resolution Bandwidth 3 MHz, 30 Hz)

Note: 30 Hz at $25^{\circ}\text{C} \pm 10^{\circ}\text{C}$

Selectivity: $< 15:1$ (100 Hz to 3 MHz)
 $< 20:1$ (30 Hz)
 $5 : 1$ (10 Hz to 100 Hz, Digital IF) Nominal

Bandwidth (6 dB): 200 Hz, 9 kHz and 120 kHz (based on CISPR specifications)

- RELATED ADJUSTMENT

- DESCRIPTION

This test measures the resolution bandwidth accuracy and selectivity. The 60 dB bandwidth is then determined and the results used to calculate the selectivity for each bandwidth (Selectivity = 60 dB BW/3 dB BW).

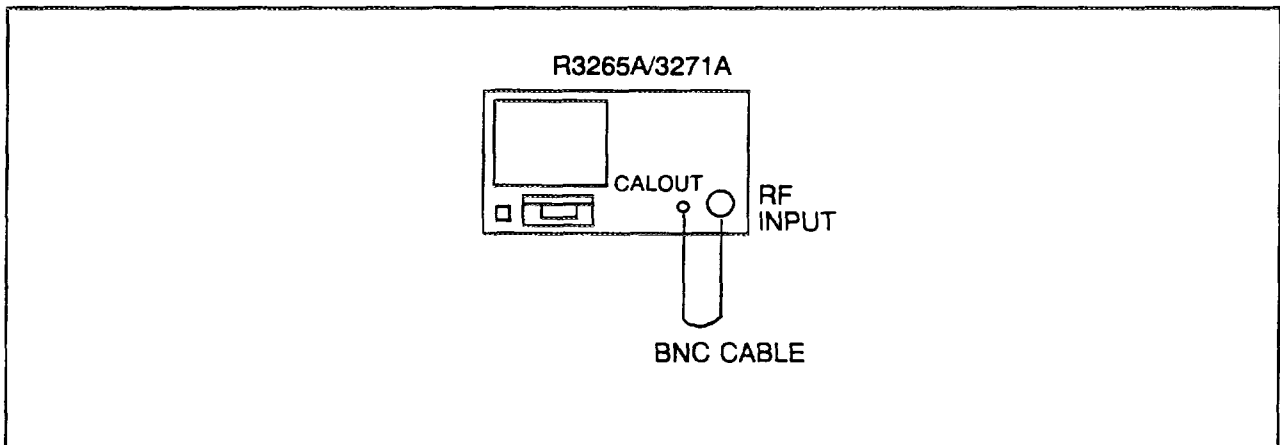

Figure 4-7 Reslution Bandwidth Accuracy/Selectivity Setup

- PROCEDURE

[Resolution Bandwidth Accuracy]

- Connect the R3265A/3271A CALOUT to the INPUT 50Ω as shown in Figure 4-7.
- Press **PRESET** and set the controls as follows:
 - Press **CENTER** **2** **5** **MHz** .
 - Press **FREQ SPAN** **5** **MHz** .
 - Press **PEF LEVEL** **5** **-dBm** and **dB/div** **1** **dB** .
 - Press **CPL** **RBW** **3** **MHz** .
 - Press **CPL** **NEXT MENU** **DIGITAL IF 1/2/OFF** **DIGITAL IF 1/2/OFF** to set Digital IF to "OFF".
 - Press **MENU** **TRACE DET** **SAMPLE** .
- Press **PEAK** , **MARKER ON** **dB DOWN** **x dB DOWN** and set **CONT DOWN ON/OFF** to ON.
- Press **MENU** **SWEEP MODE** **SINGLE SWP** , **SINGLE SWP** and wait for a new sweep to finish.
- Record the marker frequency in Tables 4-9 and 4-10 as actual 3 dB bandwidth.
- Change the RBW and span frequency as shown in Table 4-9, and repeat steps 4 and 5 for remaining RBWs.

Note : For measure RBW 100Hz to 10Hz, press the **CPL** key **NEXT MENU** and **DIGITAL IF 1/2/OFF** set Digital IF to "1".

[Resolution Bandwidth Selectivity]

- Press **PRESET** and set the controls as follows:
 - Press **CENTER FREQ** **2** **5** **MHz** .
 - Press **FREQ SPAN** **2** **5** **MHz** .
 - Press **CPL** **RBW** **3** **MHz** .
 - Press **VBW** **1** **0** **kHz** .
 - Press **CPL** key **NEXT MENU** and **DIGITAL IF 1/2/OFF** twice to set Digital IF to "OFF".
 - Press **MENU** **TRACE DET** **SAMPLE** .

- (8) Press **PEAK**, **MARKER ON**, **dB DOWN**, set **x dB DOWN** 60 dB and **CONT DOWN ON/OFF** to ON.
- (9) Press **MENU**, **SWEEP MODE**, **SINGLE SWP**, **SINGLE SWP** and wait for a new sweep to finish.
- (10) Record the marker frequency in Table 4-10 as actual 60 dB bandwidth.
- (11) Divide the 60 dB bandwidth by the 3 dB bandwidth and record as the Actual Resolution Bandwidth Selectivity in Table 4-10.
- (12) Change the RBW and span frequency as shown in Table 4-10, and repeat steps (9) through (11) for remaining RBWs.
 (For 10 Hz RBW, digital IF, set averaging to ten times because of close noise sidebands involved.)

Press **MENU**, **SWEEP MODE**, **CONT SWP**, **A**, **AVG A**, **1**, **0**, **Hz** .)

Set VBW to AUTO if RBW is 10kHz or below.

Table 4-9 Resolution Bandwidth Accuracy

Resolution Bandwidth Setting	Frequency Span Setting	3dB Bandwidth		
		Min.	Actual	Max.
3 MHz	5 MHz	2.25 MHz		3.75 MHz
1 MHz	2 MHz	850 kHz		1.15 MHz
300 kHz	500 kHz	255 kHz		345 kHz
100 kHz	200 kHz	85 kHz		115 kHz
30 kHz	50 kHz	25.5 kHz		34.5 kHz
10 kHz	20 kHz	8.5 kHz		11.5 kHz
3 kHz	5 kHz	2.55 kHz		3.45 kHz
1 kHz	2 kHz	850 Hz		1150 Hz
300 Hz	500 Hz	255 Hz		345 Hz
100 Hz	200 Hz	85 Hz		115 Hz
(*1)30 Hz	200 Hz	22.5 Hz		37.5 Hz
100 Hz, Digital IF	200 Hz	50 Hz		150 Hz
30 Hz, Digital IF	200 Hz	15 Hz		45 Hz
10 Hz, Digital IF	200 Hz	5 Hz		15 Hz

*1: The MIN and MAX values for RBW 30 Hz are those when the temperature is 25°C ± 10°C. Values for other temperature range are not specified.

Table 4-10 Resolution Bandwidth Selectivity

Resolution Bandwidth Setting	Frequency Span Setting	60 dB Bandwidth	3 dB Bandwidth	Selectivity	
				Actual	Max.
3 MHz	25 MHz				15
1 MHz	20 MHz				15
300 kHz	5 MHz				15
100 kHz	1 MHz				15
30 kHz	500 kHz				15
10 kHz	200 kHz				15
3 kHz	50 kHz				15
1 kHz	20 kHz				15
300 Hz	5 kHz				15
100 Hz	2 kHz				15
30 Hz	1 kHz				20
100 Hz, Digital IF	1 kHz				5 (nominal)
30 Hz, Digital IF	500 Hz				5 (nominal)
10 Hz, Digital IF	200 Hz				5 (nominal)

4.4.8 Resolution Bandwidth Switching Uncertainty

- SPECIFICATION

100 Hz to 3 MHz RZSBW: < ± 0.3 dB (referred to 300 kHz RES BW)

30 Hz RESBW: < ± 1 dB

Digital IF:

10 Hz to 100 Hz < 1.5 dB

- RELATED ADJUSTMENT

There is no related adjustment procedure for this performance test.

- DESCRIPTION

This test utilizes the CALOUT signal for measuring the switching uncertainty between resolution bandwidths. At each resolution bandwidth setting, the displayed amplitude variation of the signal is measured. All measurements are referenced to the 300 kHz bandwidth.

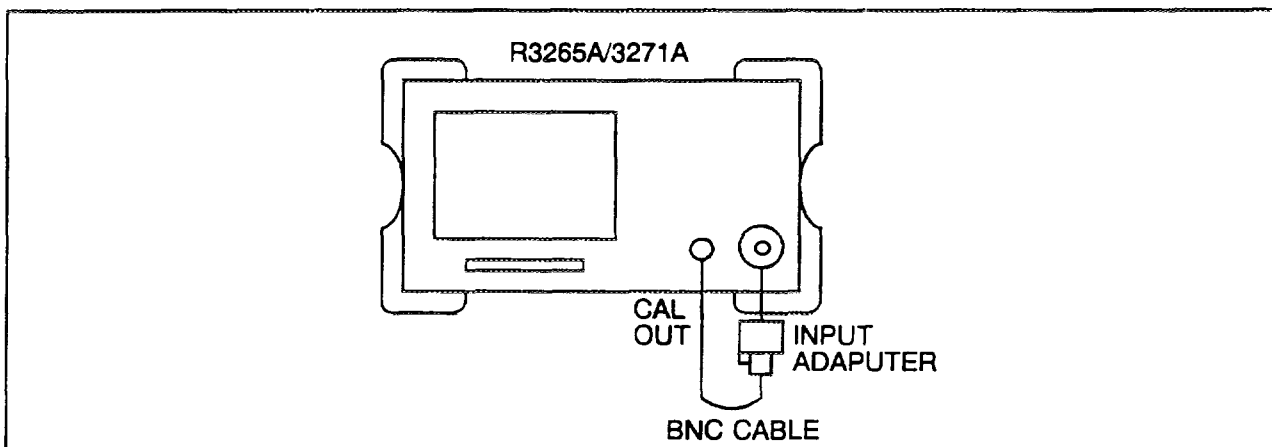

Figure 4-8 Resolution BW Switching Uncertainty Test Setup

- EQUIPMENT

Adapters :

Typed N(m) to BNC (f) JCF-AF 001E x3

Cables:

BNC 10 cm MC-61

• PROCEDURE

(1) Connect the R3265A/3271A CALOUT to the INPUT 50 Ω as shown in Figure 4-8.

(2) Press the **PRESET** key, the **SHIFT** key and the **CAL** **7** key **EACH** **ITEM** **RBW** **SWITCH**.

Wait for the "Calibration in progress" message to disappear then press

the **CPL** key, **NEXT MENU**, **DIGITAL IF** **1/2/OFF** **DIGITAL IF** **1/2/OFF** to set the Digital IF to "OFF".

Set the instrument controls as follows:

Center Freq	25 MHz
Span	1 MHz
Ref Level	-5 dBm
RBW	300 kHz
Sweep Mode	SINGLE
dB/Div	1 dB

(3) Press the **MENU** key, **SWEEP** **MODE** **SINGLE** **SWP**, the **PEAK** key and the **MARKER** **ON** key, **MARKER** **ON/OFF**.

(4) Set the frequency span and RBW to the values listed in the second entry of Table 4-11 (Span 5 MHz, RBW 3 MHz).

(5) Press the **MENU** key, **SWEEP** **MODE** **SINGLE** **SWP** and the **PEAK** key,

Record the **MARKER** amplitude in the Actual **MARKER** Reading column of Table 4-11. The **MARKER** reading should be within the limit shown.

CAUTION

Press the **CPL** key **NEXT MENU** and **DIGITAL IF** **1/2/OFF** set Digital IF to "1" when measuring the resolution BW switching uncertainty of digital IF.

(7) Repeat steps 4 and 5 for each set of frequency span and RBW settings in Table 4-11.

Table 4-11 Resolution BW Switching Uncertainty

R3265A/R3271A		Δ Marker Reading		
Span	RBW	Min. (dB)	Actual	Max. (dB)
1 MHz	300 kHz	0	0 (Ref.)	0
5 MHz	3 MHz	-0.3		+0.3
2 MHz	1 MHz	-0.3		+0.3
200 kHz	100 kHz	-0.3		+0.3
50 kHz	30 kHz	-0.3		+0.3
20 kHz	10 kHz	-0.3		+0.3
5 kHz	3 kHz	-0.3		+0.3
2 kHz	1 kHz	-0.3		+0.3
500 Hz	300 Hz	-0.3		+0.3
200 Hz	100 Hz	-0.3		+0.3
200 Hz	30 Hz	-1		+1
200 Hz	*100 Hz	-1.5		+1.5
200 Hz	*30 Hz	-1.5		+1.5
200 Hz	*10 Hz	-1.5		+1.5

*: Digital IF

4.4.9 Displayed Average Noise Level

- SPECIFICATIONS

Displayed Average Noise level: Resolution bandwidth 10 Hz, input attenuator 0 dB, video bandwidth 1 Hz.

(R3265A)

Frequency range	Average Noise Level
1 kHz	-100 dBm
10 kHz	-110 dBm
100 kHz	-111 dBm
1 MHz	-135 dBm
10 MHz to 3.6 GHz	-{140 - 1.55 × f(GHz)} dBm -{145 - 1.55 × f(GHz)} dBm (Low noise mode)
3.5 GHz to 8 GHz	-135 dBm

(R3271A)

Frequency range	Average Noise Level
1 kHz	-100 dBm
10 kHz	-110 dBm
100 kHz	-111 dBm
1 MHz to 3.6 GHz	-{135 - 1.55 × f(GHz)} dBm
3.5 GHz to 7.5 GHz	-130 dBm
7.5 GHz to 15.4 GHz	-123 dBm
15.2 GHz to 23.3 GHz	-116 dBm
23 GHz to 26.5 GHz	-110 dBm

- RELATED ADJUSTMENT

Frequency response adjustment.

- DESCRIPTION

This test measures the displayed average noise level in all frequency tests. The analyzer's input is terminated at 50 Ω . In Band 1, in the frequency range from 100 Hz to 3.6 GHz, the test first measures the average noise at 1 kHz, 10 kHz, 100 kHz and 1000 kHz, then at any frequency point in zero span. For the rest of Band 1, and for all remaining bands, the test tunes the analyzer frequency across the band, uses the marker to locate the frequency with the highest response, and then reads the average noise in zero span. In the case of the R3265A only, a LOW NOISE function is provided, so the test measures the average noise level at 25 MHz when the LOW NOISE function is set to ON.

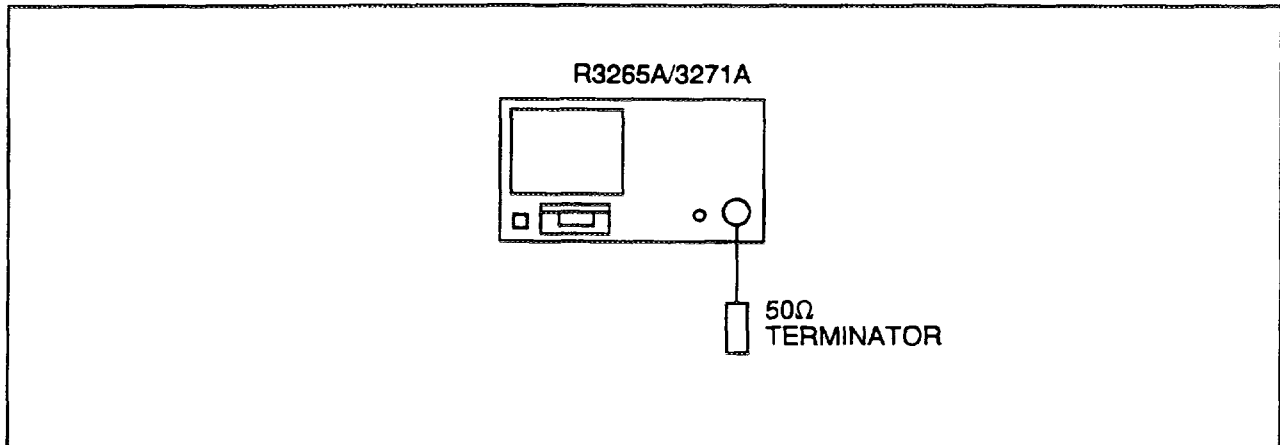

Figure 4-9 Displayed Average Noise Test Setup

- EQUIPMENT

50 Ω Terminator

● PROCEDURE

[Displayed Average Noise, Band 1]

(1) Connect the equipment as shown in Figure 4-9.

Press **PRESET** and set the controls as follows:

Center Frequency	1 kHz
Span Frequency	0 Hz
Reference Level	-60 dBm
Resolution Bandwidth	30 Hz
Digital IF	OFF
Video Bandwidth	1 Hz
Input Attenuator	0dB

(2) Press **A** **AVG** **1** **0** **Hz** and wait for averaging to finish and press **PEAK** .

(3) Read the marker level and record it in Table 4-12 as the Displayed Noise Level at 1kHz.

(4) Press **PRESET** and set the controls as follows:

Center Frequency	10 kHz
Span Frequency	0 Hz
Reference Level	-60 dBm
Input Attenuator	0 dB
Resolution Bandwidth	300 Hz
Video Bandwidth	1 Hz
Sweep Time	500 msec

(5) Press **MENU** **SWEEP** **SINGLE** and wait for a new sweep to finish,

then press **PEAK** .

- (6) Read the marker level and record it in Table 4-12 as the Displayed Noise Level at 10 kHz.
- (7) Change the center frequency to each of the values listed in column 1 of Table 4-12 and repeat step 5 sequentially. Read the marker level and record it in Table 4-12 as the Displayed Noise level at Center Frequency.

(8) Press **PRESET** and set the controls as follows:

Start Frequency	3.501 GHz
Stop Frequency	8 GHz (7.5 GHz for R3271)
Reference Level	-40 dBm
Resolution Bandwidth	3 MHz
Video Bandwidth	100 kHz
Input Attenuator	0 dB

(9) Press **A** **AVG** **A** **1** **0** **Hz** and wait for averaging to finish.

(10) Press **PEAK**, **MKR→**, **MKR→CF** and **A** **WRITE** **A**.

(11) Set the controls as follows:

Span Frequency	0 Hz
Reference Level	-60 dBm
Resolution Bandwidth	300 Hz
Video Bandwidth	1 Hz
Sweep Time	500 msec

(12) Press **MENU** **SWEEP** **MODE** **SINGLE** **SWP** **SINGLE** **SWP** and **PEAK**.

(13) Read the marker level and record it in Table 4-12 as the Displayed Average Noise Level from 3.5 GHz to 8 GHz (7.5 GHz for R3271A).

(This page has been intentionally left blank.)

[Displayed Average Noise Level, Band 2 (R3271A only)]

(14) Press and set the controls as follows:

Start Frequency	7.501 GHz
Stop Frequency	15.4 GHz
Reference Level	-40 dBm
Resolution Bandwidth	3 MHz
Video Bandwidth	100 kHz
Input Attenuator	0 dB

(15) Repeat steps (9) through (12).

(16) Read the marker level and record it in Table 4-12 as the Displayed Noise level from 7.5 GHz to 15.4 GHz.

[Displayed Average Noise, Band 3 (R3271A only)]

(17) Press and set the controls as follows:

Start Frequency	15.201 GHz
Stop Frequency	23.3 GHz
Reference Level	-40 dBm
Resolution Bandwidth	3 MHz
Video Bandwidth	100 kHz
Input Attenuator	0 dB

(18) Repeat steps (9) through (12).

(19) Read the marker level and record it in Table 4-12 as the Displayed Average Noise Level from 15.2 GHz to 23.3 GHz.

[Displayed Average Noise, Band 4 (R3271A only)]

(20) Press **PRESET** and set the controls as follows:

Start Frequency	23.001 GHz
Stop Frequency	26.5 GHz
Reference Level	-40 dBm
Resolution Bandwidth	3 MHz
Video Bandwidth	100 kHz
Input Attenuator	0 dB

(21) Repeat steps (9) through (12).

(22) Read the marker level and record it in Table 4-12 as the Displayed Average Noise Level from 23 GHz to 26.5 GHz.

[Displayed Average Noise at 25 MHz when setting the LOW NOISE function On. (R3265A only)]

(23) Press **PRESET** and set the R3265A controls as follows:

Press **REF LEVEL** and **LOW NOISE ON/OFF** set LOW NOISE to "ON".

Center Frequency	25 MHz
Span Frequency	200 Hz
Resolution Bandwidth	10 Hz (Digital IF)
Input Attenuator	0 dB
REF LEVEL	-90dBm

(24) Press **A** **AVG A** **5** **0** **Hz** and wait for averaging to finish.

(25) Press **PEAK** and read the marker level and record it as Maximum Low Noise.

Press **PEAK** **MIN** and read the marker level and record it as Minimum Low Noise.

(26) Displayed Average Noise in LOW NOISE mode is provided:

$$\text{LOW NOISE} = \frac{(\text{Maximum Low Noise} + \text{Minimum Low Noise})}{2} \text{ (dBm)}$$

Record the result as the LOW NOISE in Table 4-12.

Table 4-12 Displayed Average Noise Level (R3265A)

Frequency	Displayed Average Noise Level (dBm)	Specification (dBm)
1 kHz		-95.23
10 kHz		-95.23
100 kHz		-96.23
1 MHz		-120.23
10.1 MHz		-125.21
100 MHz		-125.07
500 MHz		-124.45
1000 MHz		-123.68
1500 MHz		-122.90
2000 MHz		-122.13
2500 MHz		-121.35
3000 MHz		-120.58
3500 MHz		-119.80
3.5 GHz to 8 GHz		-120.23
25 MHz (LOW NOISE)		-145.0

Table 4-12 Displayed Average Noise Level (R3271A)

Frequency	Displayed Average Noise Level (dBm)	Specification (dBm)
1 kHz		-95.23
10 kHz		-95.23
100 kHz		-96.23
1 MHz		-120.23
10.1 MHz		-120.21
100 MHz		-120.07
500 MHz		-119.45
1000 MHz		-118.68
1500 MHz		-117.90
2000 MHz		-117.13
2500 MHz		-116.35
3000 MHz		-115.58
3500 MHz		-114.80
3.5 GHz to 7.5 GHz		-115.23
7.5 GHz to 15.4 GHz		-108.23
15.2 GHz to 23.3 GHz		-101.23
23 GHz to 26.5 GHz		-95.23

4.4.10 Gain Compression

• SPECIFICATION

R3265A: $\left\{ \begin{array}{l} -5 \text{ dBm (mixer level) } > 200 \text{ MHz} \\ -10 \text{ dBm (mixer level) } > 10 \text{ MHz} \end{array} \right.$

R3271A: $-5 \text{ dBm (mixer level) } > 10 \text{ MHz}$

• RELATED ADJUSTMENT

There is no related adjustment procedure for this performance test.

• DESCRIPTION

This test means gain compression in the low and high bands.

Two signals, separated by 1 MHz, are used. First a -30 dBm signal is placed at the input of the R3265A/3271A.

After that, input a signal at -5 dBm or above and increase its signal level. The initial signal level at -30 dBm is lowered. Measure the input level when the signal is lowered by 1 dB .

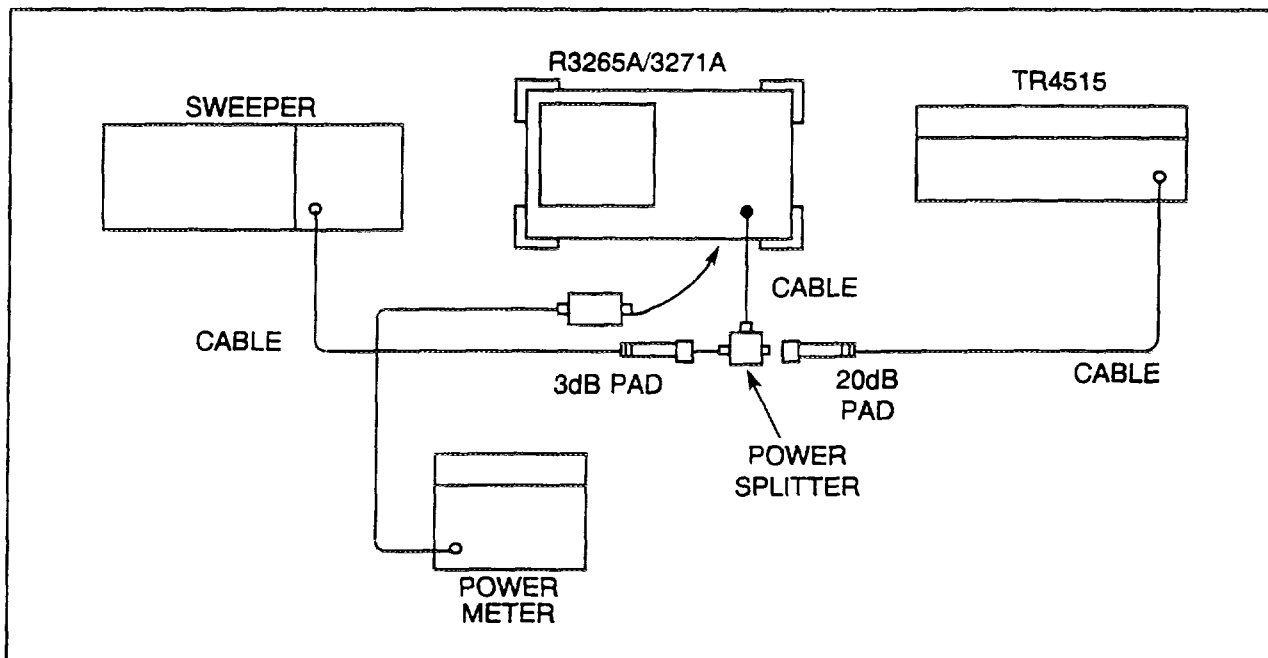

Figure 4-10 Gain Compression Test Setup

- EQUIPMENT

Synthesized Sweeper	TR4515
Sweeper	HP8350 + HP83595A
Power Meter	HP436A
Power Sensor	HP848/A
Power Splitter	Model 1579
20 dB Pad	DEE-000480-1
3 dB Pad	DEF-000685-1
Cable: SMA (3 required)	

- - PROCEDURE

- (1) Zero and calibrate the power meter.
- (2) Connect the equipment as shown in Figure 4-10.
- (3) Press the INSTR PRESET by on both the TR4515 and the sweeper.
Set the controls for the HP8350 as follows:

CW	11 MHz
CW Filter	ON
Power Level	-2 dBm

- (4) Set the controls for the TR4515 as follows:

CW	10 MHz
Power Level	-4 dBm

- (5) On the R3265A/3271A, press the PRESET key.
Set the R3265A/3271A controls as follows:

Center Freq	10.5 MHz
Span	20 MHz
ATT	0 dB
dB/div	1 dB/div

- (6) On the HP8350, press the vernier key.
 Turn the vernier knob of the HP8350 so that the displayed signal on the R3265A/3271A screen enters the range within ± 2 div. from the center on the horizontal axis.
 On the R3265A/3271A, press SPAN and ↓ .
 Turn the vernier knob of the HP8350 so that the displayed signal on the R3265A/3271A screen enters the range within ± 1 div. from the center on the horizontal axis.
 On the R3265A/3271A, press SPAN and ↓ .
 Turn the vernier knob of the HP8350 so that the displayed signal on the R3265A/3271A screen enters the range within ± 1 div. from the center on the horizontal axis.
 On the R3265A/3271A, press SPAN and ↓ .
 Turn the vernier knob of the HP8350 so that the displayed signal on the R3265A/3271A screen enters the range of 2.5 div. ± 0.5 div. on the right side of the center on the horizontal axis.
 Now, the frequency of the HP8350 output signal is set to 11 MHz ± 0.1 MHz.
- (7) On the R3265A/3271A, set the REF LEVEL to -30 dBm.
- (8) On the HP8350, press the RF key to set the output to OFF.
- (9) Adjust the power level of the TR4515 for a displayed signal level of -30 dBm ± 0.1 dB on the R3265A/3271A screen.
- (10) On the HP8350, press the RF key to set the output to ON.
- (11) Turn the power level knob on the HP8350 until the signal level at 2.5 div. in the lefthand part on the R3265A/3271A screen is lowered by 1 dB from -30 dBm. If the power level knob cannot be turned any more, stop it there.
- (12) Remove the SMA cable from the input terminal of the R3265A/3271A and connect the power sensor there.
- (13) Record the amplitude reading on the power meter.
 It should be greater than -5 dBm (R3265A: -10 dBm)

_____ dBm

Steps 14 through 18 are not necessary for the R3271A.

- (14) Set the HP8350 controls as follows:

CW 200 MHz

(15) Set the TR4515 controls as follows:

CW 200 MHz

(16) Set the R3265A controls as follows:

Center Freq 200.5 MHz
 Span 20 MHz
 Ref Level -10 dBm

(17) Repeat steps (6) through (12).

(18) Record the amplitude reading on the power meter.
 It should be greater than -5 dBm.

The following steps are to be performed for both the R3265A and R3271A.

(19) Rotate the CAL FACTOR switch to the power sensor's 3.6 GHz calibration factor.

(20) Set the HP8350 controls as follows:

CW 3.6 GHz
 Power Level -2dBm

(21) Set the TR4515 controls as follows:

CW 3.6 GHz

(22) Set the R3265A/3271A controls as follows:

Center Freq 3.6005 GHz
 Span 20 MHz
 Ref Level -10 dBm
 dB/div 10 dB

(23) On the R3265A/3271A, press MARKER

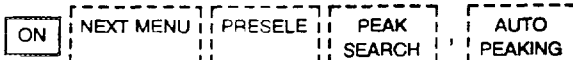

Wait for the "peaking!!" message to disappear.
 Set the dB/div to 1dB/div.

- (24) Repeat steps (6) through (12).
- (25) Record the amplitude reading on the power meter.
 It should be greater than -5 dBm.



_____ dBm

Table 4-13 Gain Compression

R3265A/71A Center Freq (MHz)	TR4515 CW (MHz)	HP8350 CW (MHz)	1dB Gain Compression level (dBm)
10.5	10	11	
200.5	200	201	
3600.5	3600	3601	

4.4.11 Residual Response

- SPECIFICATION

R3265A:		1 MHz to 3.6 GHz < - 100 dBm (with no signal at input and 0 dB input attenuation)
		300 kHz to 8 GHz < - 90 dBm
R3271A:		1 MHz to 3.6 GHz < - 100 dBm
		300 kHz to 8 GHz < - 90 dBm

- RELATED ADJUSTMENT

There is no related adjustment for this performance test.

- DESCRIPTION

This test checks for residual responses. Any response located above the display line is measured in a narrow frequency span and resolution bandwidth. The RF INPUT is terminated in 50 Ω.

- EQUIPMENT

Coaxial 50 Ω Termination

Adapters:

Type N to SMA	HRM-554s
Type N to BNC	

Cable:

BNC, 150cm	MI-09
------------------	-------

- PROCEDURE

(1) On the R3265A/3271A, press the PRESET key and set the controls as follows;

Center Freq	25 MHz
Span	10 kHz
Ref Level	- 10 dBm
RES BW	300 Hz
ATT	0 dB

- (2) Connect a BNC cable between the CAL OUTPUT and the RF INPUT and press the **PEAK** Key.

Check that the marker amplitude is within $-10.0 \text{ dBm} \pm 0.2 \text{ dB}$. If it is out of the range,

press **SHIFT**, **CAL** **7** and **CALL ALL**. Then, re-check that the marker amplitude is within

$-10.0 \text{ dBm} \pm 0.2 \text{ dB}$.

<< Residual Responses, base band >>

- (3) Remove the BNC cable and adapter from the RF INPUT.
Install the Type N to SMA adapter and 50Ω termination on the RF INPUT. Press the **PRESET** key and set the controls as follows:

Center Freq	1.3 MHz
Span	2 MHz
CF Step	1.9 MHz
Ref Level	- 50 dBm
ATT	0 dB
RES BW	10 kHz
Video BW	300Hz

- (4) Press **MENU** key **DSP LINE ON/OFF** and **1 0 0**, **-dBm** key.

Press **MENU** key **SWEEP MODE** and **SINGLE SWP**.

The noise level should be at least 3 dB below the display line. If it is not, it will be necessary to reduce the Span and RES BW to reduce the noise level.

If the Span is reduced, reduce the CF Step to no more than 95 % of the Span.

- (5) If a residual is suspected, press **SINGLE SWP** again. A residual response will persist, but a noise peak will not. Record the frequency and amplitude of any responses above the display line.

(6) If a response is marginal, verify the response amplitude as follows:

- ① Press the **SHIFT** and **RECALL** key, **I**, **Hz** key, **SAVE EXECUTE**.
- ② Press the **MENU** key, **SWEEP MODE**, **CONT SWP**.
- ③ Place the marker on the peak of the response in question.
- ④ Press the **MKR→** key, **MKR→CF**.
- ⑤ Press the **CPL** key, **RBW**, **AUTO**.
- ⑥ Continue to reduce the Span until a RES BW of 300 Hz is reached.

Press **PEAK** **MKR→** **MKR→CF** set peak to center.

- ⑦ Record the frequency and amplitude of any residual response above the display line.
- ⑧ Press the **RECALL** key, **RECALL EXECUTE**.

(7) Check for residuals up to 3.599 GHz using the procedure of step (4) through (6) above. To change the center frequency, then press the **CENTER FREQ** and **↑** keys.

< < Residual Response, 3.5 to 7.5 GHz Band > >

(8) Set the R3265A/3271A as follows:

Center Freq	3.625 GHz
Span	50 MHz
CF Step	47.5 MHz
RES BW	300 kHz
Video BW	300 Hz

Press the **MENU** key, **DSP LINE ON/OFF** **9** **0** **-dBm** key.

(9) Check for residuals up to center frequency 7.425GHz using the procedure of steps (4) through (6) above. To change the center frequency, then press the **CENTER FREQ** and **↑** keys.

Lastly check for residuals at center frequency 7.475GHz using the procedure of steps (4) through (6) above.

4.4.12 Second Harmonic Distortion

- SPECIFICATION

R3265A:	{	- 70 dBc (100 MHz to 3.6 GHz, - 30 dBm mixer level)
	{	- 60 dBc (10 MHz to 3.6 GHz, - 30 dBm mixer level)
	{	- 100 dBc (>3.6 GHz, - 10 dBm mixer level)
R3271A:	{	- 70 dBc (10 MHz to 3.6 GHz, - 30 dBm mixer level)
	{	- 100 dBc (>3.6 GHz, - 10 dBm mixer level)

- RELATED ADJUSTMENT

There is no related adjustment procedure for the performance test.

- DESCRIPTION

A synthesized sweeper and low-pass filter provide the signal for measuring second harmonic distortion. The low-pass filter eliminates any harmonic distortion originating at the signal source. The R3265A/3271A frequency response is calibrated. The synthesized sweeper is phase-locked to the spectrum analyzer's 10 MHz reference.

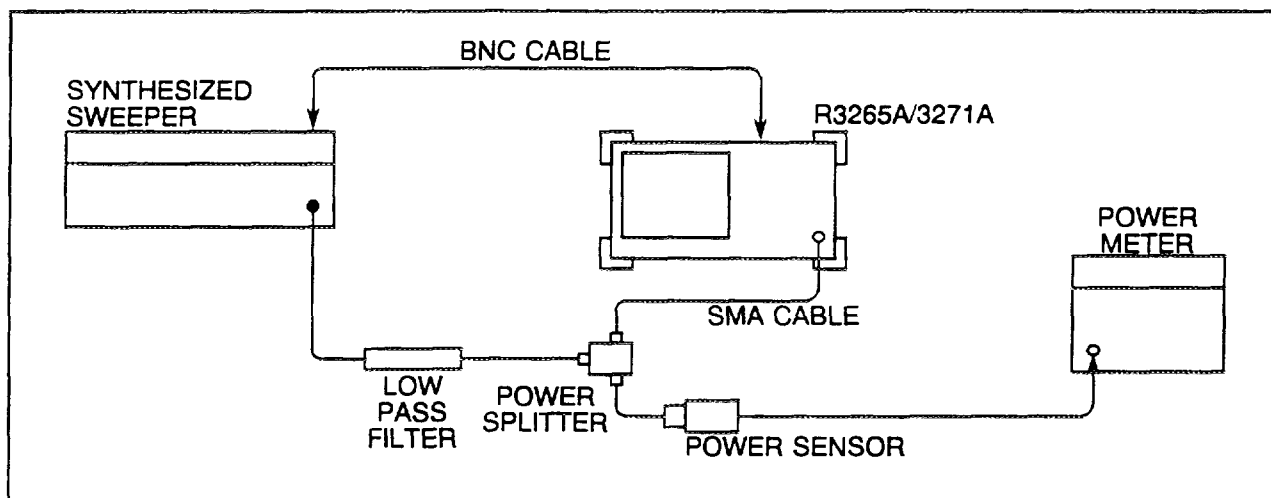

Figure 4-11 Second Harmonic Distortion Test Setup

• EQUIPMENT

Synthesized Sweeper	TR4515
Power Meter	HP436A
Power Sensor	HP8485A or HP8481A
Power Splitter	Model 1579
2 GHz Low-pass Filter	DEE-001172-1
Adapter:	
Type N to SMA	HRM-554S
Cables:	
BNC, 150 cm	MI-09
SMA, 70 cm	A01002

• PROCEDURE

[100 Hz to 3.6 GHz Band]

(1) Zero and calibrate the power meter. Rotate the CAL FACTOR switch to the power sensor's 1.5 GHz calibration factor.

(2) Connect the equipment as shown in Figure 4-11.

(3) Press the INSTR PRESET key on the TR4515. Set the TR4515 controls as follows:

CW	1.5 GHz
Power Level	0 dBm
Frequency Standard Switch (rear panel)	EXT 10 MHz

(4) On the R3265A/3271A, press PRESET and set the controls as follows:

Center Freq	1.5 GHz
Span	10 kHz
VBW	30 Hz
ATT	20 dB
Ref Level	- 10 dBm

(5) Set the TR4515 POWER LEVEL key for a -10 dBm ± 0.1 dB reading on the power meter.

(6) On the R3265A/3271A, press MENU SWEEP
MODE SINGLE
SWP , PEAK , MARKER ON MKR

FIXED MKR
ON/OFF

- (7) On the R3265A/3271A, press , .
 Wait for completion of the sweep.
 Press and record the amplitude of .
 It should be less than -70 dBc.

Second Harmonic Distortion (< 3.6 GHz) _____ dBc

[>3.6 GHz Band]

- (8) Remove the low-pass-filter and connect an SMA cable between the TR4515 and the R3265A/3271A.

- (9) On the R3265A/3271A, press and set the controls as follows:

Center Freq	3.8 GHz
Span	500 kHz

- (10) Set the TR4515 controls as follows:

CW	3.8 GHz
Power Level	- 10 dBm

- (11) On the R3265A/3271A, press MAKER .
 Wait for the "peaking" message to disappear.

- (12) Set the TR4515 controls as follows:

CW	1.9 GHz
Power Level	0 dBm

- (13) Connect the equipment as shown in Figure 4-11.

- (14) Rotate the CAL FACTOR switch to the power sensor's 1.9 GHz calibration factor.

- (15) Set the TR4515 key for a 0 dBm ± 0.1 dB reading on the power meter.

(16) Set the R3265A/3271A center frequency to 1.9 GHz and span to 1 kHz.

Press **PEAK** **MAKER** **ON** **MKR** **FIXED MKR**
 ON/OFF

Set the center frequency to 3.8 GHz and ref-level to -40 dBm.

Press **A** **AVG** **A** **2** **0** **Hz** .

Wait for the end of 20 averagings.

Press **PEAK** and record the **MKR** amplitude.

It should be less than - 100 dBc

Second Harmonic Distortion (> 3.6 GHz) _____ dBc

4.4.13 Third Order Intermodulation Distortion

- SPECIFICATION

For a total mixer input level* of -30 dBm:

R3265A	R3271A
10 MHz to 3.6 GHz : < - 60 dBc	10 MHz to 3.6 GHz : - 70 dBc
200 MHz to 3.6 GHz : < - 70 dBc	
3.5 GHz to 8 GHz : < - 75 dBc	3.5 GHz to 26.5 GHz : < - 75 dBc

* Total mixer input level = Total Input Level - Input Attenuation

Converted Specification for a total mixer input level* of -20dBm:

R3265A	R3271A
10 MHz to 3.6 GHz : < - 40 dBc	10 MHz to 3.6 GHz : < - 50 dBc
200 MHz to 3.6 GHz : < - 50 dBc	
3.5 GHz to 8 GHz : < - 55 dBc	3.5 GHz to 26.5 GHz : < - 55 dBc

- RELATED ADJUSTMENT

There is no related adjustment procedure for this performance test.

- DESCRIPTION

Two synthesized sweepers provide the signals required for measuring third order intermodulation.

It is difficult when the input level is low because of being buried to the noise, to measure the spectrum generated by the distortion. Third order intermodulation distortion is raised by 20dB if the input level is raised by 10dB.

Then, examine with mixer input level set in -20dBm after the spec is converted into a value which is 20dB larger.

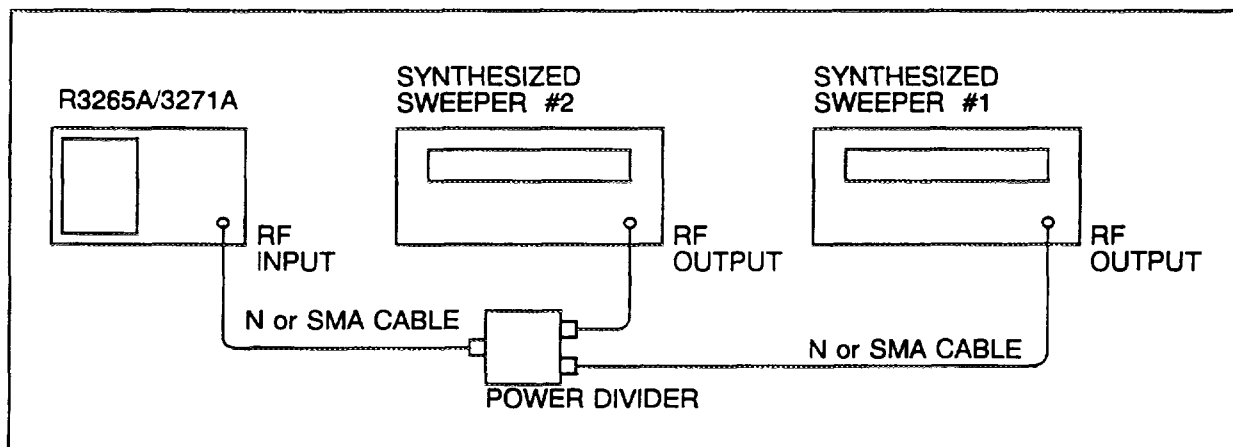

Figure 4-12 Third Order Intermodulation (<300 MHz) Test Setup

- EQUIPMENT

Instrument	Critical Specifications for Equipment Substitution	Recommended Model
Synthesized Sweeper	Frequency Range: 10 MHz to 4 GHz Power Level: - 10 to 0 dBm	TR4515 R4262
Power Divider #1	Frequency Range: 10 MHz to 300 MHz Isolation: > 20 dB	H-8-4 (ANZAC)
Power Divider #2	Frequency Range: 1 GHz to 4 GHz	4313-2 (NARDA)

- PROCEDURE

The following procedure carryout at -20dBm for a total mixer input level.

[Third Order Intermodulation (<300 MHz)]

- Select power divider #1 and connect the units as shown in Figure 4-12.
- Press the **INSTR PRESET** key on each synthesized sweeper. Set each of the synthesized sweeper controls as follows:

Power Level	- 10 dBm
CW (synthesized sweeper #1)	10.5 MHz (205 MHz)
CW (synthesized sweeper #2)	10.6 MHz (205.1 MHz)
RF Out	OFF

- On the R3265A/3271A, press the **PRESET** key. Set the R3265A/3271A controls as follows:

Center Freq	10.5 MHz (205 Mhz)
Ref Level	- 10 dBm
Freq Span	1 MHz
RBW	3 kHz
VBW	300 Hz
ATT	10 dB

- On the synthesized sweeper #1, set the **RF OUT** key to ON.

- On the R3265A/3271A, press the **PEAK** key, **NEXT MENU** and **CONT PK ON/OFF**.

- (6) On the synthesized sweeper #1, adjust the POWER LEVEL key for a $-10 \text{ dBm} \pm 0.1 \text{ dB}$ reading on the R3265A/3271A display.
- (7) On the synthesized sweeper #1, set the RF OUT key to OFF. On the synthesized sweeper #2, set the RF OUT key to ON.
- (8) On the synthesized sweeper #2, adjust the POWER LEVEL key for a $-10 \text{ dBm} \pm 0.1 \text{ dB}$ reading on the R3265A/3271A display.
- (9) On the synthesized sweeper #1, set the RF OUT key to ON.
- (10) On the R3265A/3271A, press the following keys: CONT PK
ON/OFF and the PEAK key.

Wait for a new sweep to finish, then press the following keys: the A key,

VIEW
A, the PEAK key, ON key and MKR.

- (11) Third order intermodulation distortions appear symmetrically 100 kHz apart from the two carriers. Move MKR to each distorted position with the knob or ↑ key, read the level in dBc and record the greater reading.
- (12) For the R3271A, only measurement with 10.5 MHz center frequency is made. For the R3265A, repeat the steps for measurement with 205 MHz center frequency and record its result.

[Third Order Intermodulation, 3.6 GHz]

- (13) Switch power divider #1 to #2.
- (14) Press the INSTR PRESET key on each synthesized sweeper. Set each of the synthesized sweeper controls as follows:

Power Level	- 10 dBm
CW (synthesized sweeper #1)	3.6 GHz
CW (synthesized sweeper #2)	3600.1 GHz
RF Out	OFF

(15) On the R3265A/3271A, press the **PRESET** key. Set the R3265A/3271A controls as follows:

Center Freq 3.6 GHz
 Ref Level - 10 dBm
 Span 1 MHz
 (RBW) 3 kHz
 (ATT) 10 dB
 (VBW) 100 HZ

(16) Repeat steps (4) to (11) to measure the third order intermodulation distortions and record the greater reading.

Table 4-14 Third Order Intermodulation Distortion

(R3265A)

Sythesized Sweeper #1 [CW] (MHz)	Sythesized Sweeper #2 [CW] (GHz)	Third Order Intermodulation Distortion	
		Actual (dBc)	Max (dBc)
10.5	10.6		-40
205	205.1		-50
3600	3600.1		-55

(R3271A)

Sythesized Sweeper #1 [CW] (MHz)	Sythesized Sweeper #2 [CW] (GHz)	Third Order Intermodulation Distortion	
		Actual (dBc)	Max (dBc)
10.5	10.6		-50
3600	3600.1		-55

4.4.14 Image, Multiple and Out-of-Band Response

- SPECIFICATION

Image, Multiple and Out-of-Band Response:

R3265A: - 70 dBc (10 MHz to 8 GHz)

R3271A: { - 70 dBc (10 MHz to 18 GHz)
 - 60 dBc (10 MHz to 23 GHz)
 - 50 dBc (10 MHz to 26.5 GHz)

- RELATED ADJUSTMENT

YTF adjustment

- DESCRIPTION

The performance tests in the R3265A and R3271A differ in measurement frequency. Make measurement with each band.

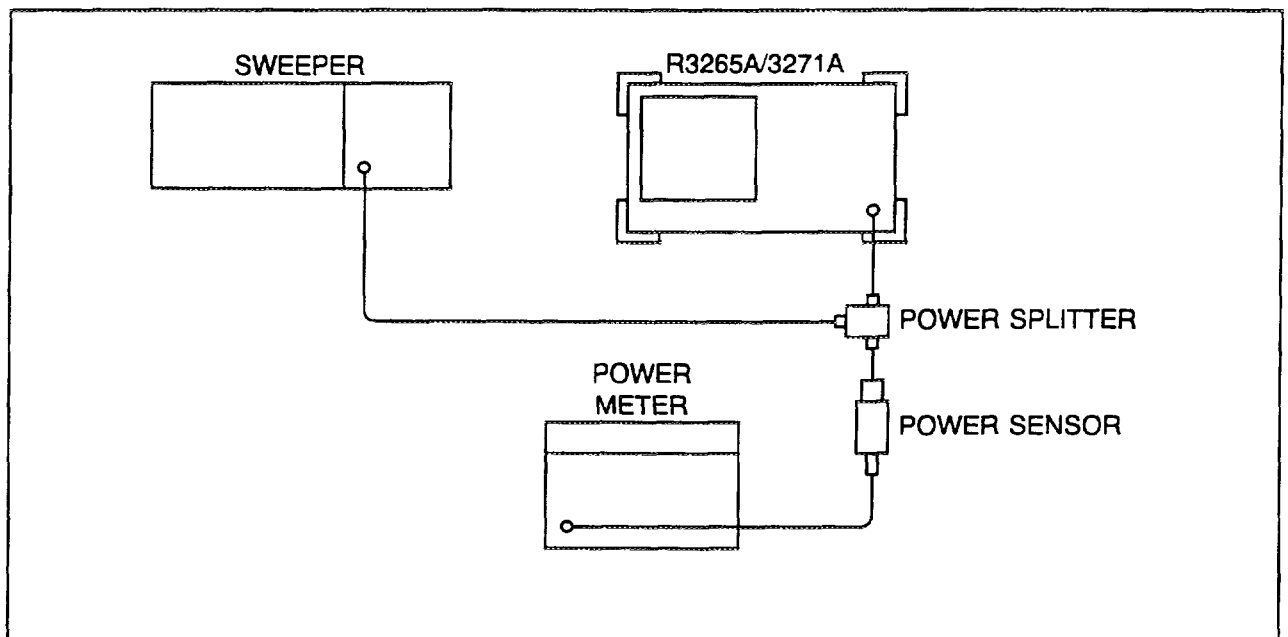

Figure 4-13 Image, Multiple and Out-of-Band Response Test Setup

● EQUIPMENT

Sweeper	HP8350 + HP83594A
Power Meter	HP436A
Power Sensor	HP8485A
Power Splitter	Model 1579
Adapter:	
Type N to SMA	HRM-554S
Cables:	
SMA, 70 cm	A01002

● PROCEDURE

[100 Hz to 3.6 GHz Band (R3265A/3271A)]

(1) Connect the equipment as shown in Figure 4-13, but do not connect the power sensor.

(2) Press the **INSTR PRESET** key on the sweeper and set the controls as follows:

CW	2 GHz
Power Level	0 dBm

(3) On the R3265A/3271A, press the **PRESET** key and set the controls as follows:

Center Freq	2 GHz
Span	40 MHz
RBW	100 kHz
VBW	300 Hz

(4) Zero and calibrate the power meter. Rotate the CAL FACTOR switch to the power sensor's 2 GHz calibration factor.

Connect the power sensor to the power splitter.

(5) Adjust the sweeper **POWER LEVEL** key for a 0 dBm ± 0.1 dB reading on the power meter.

On the R3265A/3271A, press **PEAK** , **MKR→** , **MKR→CF** , **SPAN** **5** **MHz** **MENU**

(6) **SWEEP MODE** **SINGLE SWP** , **PEAK** **MARKER** **ON** **MKR** **FIXED MKR ON/OFF** **SPAN** **4** **0** **MHz** .

- (7) For each of the frequencies listed in Table 4-16 (R3271A) for the 100 Hz to 3.6 GHz band, do the following:
- ① Set the sweeper to the listed **CW** key frequency.
 - ② On the power meter, rotate the CAL FACTOR switch to the appropriate power sensor calibration factor.
 - ③ Set the sweeper **POWER LEVEL** key for a 0 dBm reading on the power meter.
 - ④ Press **MENU** **SWEEP MODE** **SINGLE SWP** on the R3265A/3271A.
 - ⑤ On the R3265A/3271A, press **PEAK** and record the Δ MKR amplitude in Table 4-16 (R3271A) as the response amplitude. The response amplitude should be less than the specification listed in the table.
- (8) On the R3265A/3271A, press the **MARKER OFF** , **MENU** **SWEEP MODE** **CONT SWP** .
- Measurement frequency for the R3265A is different for the following bands. Therefore, skip steps (9) to (27) and restart from step (28). The following steps are for the R3271A.

[3.5 to 7.5 GHz Band (R3271A Only)]

- (9) Set the R3271A center frequency to 5.5 GHz. Set the sweeper CW to 5.5 GHz.
- (10) Rotate the CAL FACTOR switch to the power sensor's 5.5 GHz calibration factor on the power meter.
- (11) On the sweeper, set the power level to the power meter indicate 0dBm.

On the R3271A, press PEAK MKR→ MKR→CF , SPAN 5 MHz , MARKER ON

NEXT MENU PRESELE PEAK SEARCH , AUTO PEAKING . Wait for the "peaking!!" message to

disappear.

Press MENU SWEEP MODE SINGLE SWP , PEAK MARKER ON MKR FIXED MKR ON/OFF SPAN 4

0 MHz .

- (12) Repeat steps (7) and (8) for the sweeper frequencies listed in Table 4-16 for the 3.5 GHz to 7.5 GHz band.

[7.4 GHz to 15.4 GHz Band (R3271A Only)]

- (13) Set the R3271A center frequency to 12 GHz. Set the sweeper CW to 12 GHz.
- (14) Rotate the CAL FACTOR switch to the power sensor's 12 GHz calibration factor on the power meter.
- (15) Repeat step (11) for the R3271A.
- (16) Repeat steps (7) and (8) for the sweeper frequencies listed in Table 4-16 for the 7.4 GHz to 15.4 GHz band.

[15.2 GHz to 23.3 GHz Band (R3271A Only)]

- (17) Set the R3271A CENTER FREQ to 21 GHz. Set the sweeper CW to 21 GHz.
- (18) Rotate the CAL FACTOR switch to the power sensor's 21 GHz calibration factor on the power meter.
- (19) Repeat step (11) for the R3271A.
- (20) Repeat steps (7) and (8) for the sweeper frequencies listed in Table 4-16 for the 15.2 to 23.3 GHz band.

[23 to 26.5 GHz Band (R3271A Only)]

- (21) Set the R3271A center frequency to 24.4 GHz. Set the sweeper CW to 24.4 GHz.
- (22) Rotate the CAL FACTOR switch to the power sensor's 24.4 GHz calibration factor on the power meter.
- (23) Repeat step (11) for the R3271A.
- (24) Repeat steps (7) and (8) for the sweeper frequencies listed in Table 4-16 for the 23 to 26.5 GHz band.
- (25) Record the maximum response amplitude from Table 4-16.
(At frequency less than 18 GHz)

Maximum Response Amplitude (< 18 GHz) _____ dBc

(26) Record the maximum response amplitude from Table 4-16.

(At frequency ranging from 18 to 23 GHz)

Maximum Response Amplitude(< 23 GHz) _____dBc

(27) Record the maximum response amplitude from Table 4-16.

(At frequency ranging from 23 to 26 GHz)

Maximum Response Amplitude(< 26.5GHz) _____dBc

The following steps are for the R3265A.

[3.5 to 8 GHz Band (R3265A Only)]

(28) Set the R3265A center frequency to 7 GHz. Set the sweeper CW to 7 GHz.

(29) Rotate the CAL FACTOR switch to the power sensor's 7 GHz calibration factor on the power meter.

(30) On the sweeper, set the power level to the power meter indicate 0dBm.

On the R3265A, press PEAK MKR→ MKR→CF , FREQ SPAN 5 MHz ,

MARKER ON NEXT MENU PRESELE PEAK SEARCH AUTO PEAKING . Wait for the "peaking!!" message to disappear.

Press MENU SWEEP MODE SINGLE SWP , PEAK MARKER ON MKR FIXED MKR ON/OFF FREQ SPAN 4 0 MHz .

(31) Repeat steps (7) and (8) for the sweeper frequency listed in Table 4-17 for the 3.5 to 8GHz band's 7GHz center frequency.

(32) Set the R3265A center frequency to 8GHz. Set the sweeper CW to 8GHz.

(33) Rotate hte CAL FACTOR switch to the power sensor's 8GHz calibration factor on the power meter.

- (34) Repeat step (30) for the R3265A.
- (35) Repeat steps (7) and (8) for the sweeper frequencies listed in Table 4-17 for the 3.5 to 8 GHz band's 8 GHz center frequency.
- (36) Record the maximum response amplitude from Table 4-17.

Maximum Response Amplitude _____ dBc

Table 4-16 Image, Multiple and Out-of-Band Responses (R3271A)

Band	R3271A Center Freq. (GHz)	SG CW (MHz)	Response Amplitude (dBc)	Specification (dBc)
100 Hz to 3.6 GHz Band	2.0	1957.159		-70
	2.0	1157.159		-70
	2.0	10462.841		-70
	2.0	8231.4205		-70
3.5 GHz to 7.5 GHz Band	5.5	6342.841		-70
	5.5	11421.421		-70
	5.5	17342.841		-70
	5.5	23264.262		-50
7.4 GHz to 15.4 GHz Band	12.0	12842.841		-70
	12.0	5789.29		-70
	12.0	18210.71		-60
	12.0	24421.421		-50
15.2 GHz to 23.3 GHz Band	21.0	21842.841		-60
	21.0	6719.053		-70
	21.0	13859.527		-70
23 GHz to 26.5 GHz Band	24.4	25242.841		-60
	24.4	5783.935		-70
	24.4	11989.29		-70
	24.4	18194.645		-60

Table 4-17 Image, Multiple and Out-of-Band Responses (R3265A)

Band	R3265A Center Freq. (GHz)	SG CW (MHz)	Response Amplitude (dBc)	Specification (dBc)
100 Hz to 3.6 GHz Band	2.0	1957.159		-70
	2.0	1157.159		-70
	2.0	10462.841		-70
	2.0	8231.4205		-70
3.5 GHz to 8 GHz Band	7.0	7842.841		-70
	8.0	4632.131		-70
	8.0	3789.29		-70

4.4.15 Frequency Response

● SPECIFICATION

R3265A:	}	± 1.5 dB (100 Hz to 3.6 GHz)	(10 dB Input Attenuation)
		± 1.0 dB (50 MHz to 2.6 GHz)	
		± 1.5 dB (3.5 GHz to 7.5 GHz)	
		± 1.5 dB (7.4 GHz to 8 GHz)	
R3271A:	}	± 1.5 dB (100 Hz to 3.6 GHz)	
		± 1.0 dB (50 MHz to 2.6 GHz)	
		± 1.5 dB (3.5 GHz to 7.5 GHz)	
		± 3.5 dB (7.4 GHz to 15.4 GHz)	
		± 4.0 dB (15.4 GHz to 23.3 GHz)	
		± 4.0 dB (23 GHz to 26.5 GHz)	

Frequency response relative to the calibrator (25 MHz): $< \pm 5$ dB

Band switching uncertainty: $< \pm 0.5$ dB

● RELATED ADJUSTMENT

YTF adjustment.

Frequency response adjustment.

● DESCRIPTION

The sweeper signal is fed through a power splitter to a power sensor and the R3265A/3271A. The sweeper's power level is adjusted at 25 MHz to place the displayed signal at the R3265A/3271A center horizontal graticule line. The power meter is placed in RATIO mode. At each new sweeper frequency, the sweeper's power level is adjusted to the center horizontal graticule line. The power meter displays the inverse of the frequency response relative to the calibrator.

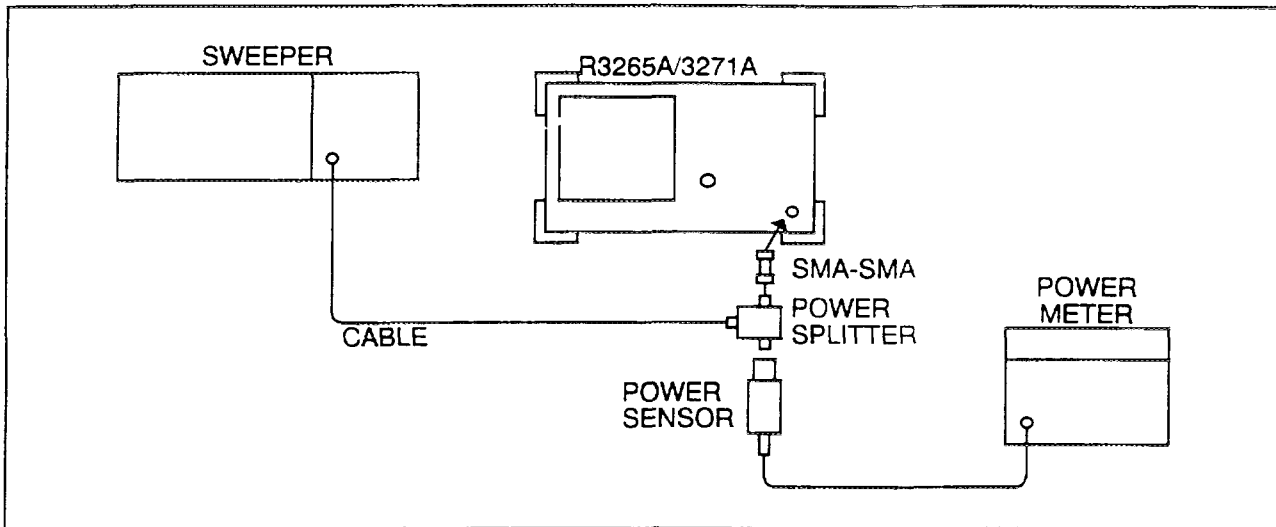

Figure 4-14 Frequency Response Test Setup

• EQUIPMENT

Sweeper	HP8350 + HP83595A
Power Meter	HP436A
Power Sensor	HP8485A
Power splitter	
Adapter:	
Type N to SMA	HRM-554S
SMA (m) to SMA (m)	50-673-0000-31
Cables:	
SMA, 70 cm	A01002

• PROCEDURE

- (1) Zero and calibrate the power meter.
- (2) Connect the equipment as shown in Figure 4-14.
- (3) Press the INSTR PRESET key on the sweeper. Set the sweeper controls as follows:

CW	25 MHz
Freq Step	100 MHz
Power Level	- 4 dBm

- (4) On the R3265A/3271A, press the key.

Center Freq	25 MHz
CF Step	100 MHz
Span	40 MHz
Ref Level	- 5 dBm
dB/div	1 dB/div
RBW	3 MHz
VBW	1 KHz

- (5) Press

- (6) Adjust the sweeper vernier for a MKR frequency reading 100MHz ± 2MHz.

Adjust the sweeper POWER LEVEL for a MKR amplitude reading of - 10 dBm ± 0.09 dB.

- (7) Press the switch on the power meter.

[Frequency Response (R3265A/3271A: 100 Hz to 3.6 GHz Band)]

- (8) Set the sweeper to 100 MHz.

- (9) Set the R3265A/3271A to 100 MHz.

- (10) Adjust the sweeper POWER LEVEL for an R3265A/3271A MKR amplitude reading of - 10 dBm ± 0.09 dB.

- (11) Record the reverse sign value of the power ratio displayed on the power meter in Table 4-18.

- (12) On the sweeper, press the and keys.

On the R3265A/3271A, press the and keys.

At each new frequency, repeat steps (10) and (11), rotating the CAL FACTOR switch to the power sensor's calibration factor

When the peak is out of CRT display, adjust the VERNIER of the sweeper for near the center.

[Frequency Response (R3265A/3271A: 3.5 to 7.5 GHz Band)]

- (13) Set the R3265A/3271A to 3.6 GHz.
- (14) Set the sweeper to 3.6 GHz.
- (15) On the R3265A/3271A, press MARKER , .
Wait for the "peaking!!" message to disappear.
- (16) Adjust the sweeper POWER LEVEL for an R3265A/3271A MKR amplitude reading of $-10 \text{ dBm} \pm 0.09 \text{ dB}$.
- (17) Record the reverse sign value of the power ratio displayed on the power meter in Table 4-19.
- (18) On the sweeper, press the and keys.
On the R3265A/3271A, press the and keys.
At each new frequency, repeat steps (15) through (17), rotating the CAL FACTOR switch to the power sensor's calibration factor.
When the peak is out of CRT display, adjust the VERMER of sweeper for near the center.

[Frequency Response (R3265A: 7.5 to 8.0 GHz Band) (R3271A: 7.5 to 15.4 GHz Band)]

- (19) Set the R3265A/3271A to 7.5 GHz and to 200 MHz.
- (20) Set the sweeper to 7.5 GHz and to 200 MHz.
- (21) On the R3265A/3271A, press MARKER , .
Wait for the "peaking!!" message to disappear.
- (22) Adjust the sweeper POWER LEVEL for an R3265A/3271A MKR amplitude reading of $-10 \text{ dBm} \pm 0.09 \text{ dB}$.
- (23) Recording the reverse sign value of the power ratio displayed on the power meter in Table 4-20.

- (24) On the sweeper, press the **CW** and **↑** keys.
On the R3265A/3271A, press the **CENTER FREQ** and **↑** keys.
At each new frequency, repeat steps (21) through (23), rotating the CAL FACTOR switch to the power sensor's calibration factor.

[Frequency Response (R3271A: 15.4 to 23.3 GHz Band)]

- (25) Set the R3271A **CENTER FREQ** to 15.4 GHz.
- (26) Set the sweeper **CW** to 15.4 GHz.
- (27) On the R3271A, press MARKER **ON** **NEXT MENU** **PRESELE** **PEAK SEARCH** **AUTO PEAKING**.
Wait for the "peaking!!" message to disappear.
- (28) Adjust the sweeper POWER LEVEL for an R3271A MKR amplitude reading of -10 dBm ± 0.09 dB.
- (29) Record the negative value of the power ratio displayed on the power meter in Table 4-21.
- (30) On the sweeper, press the **CW** and **↑** keys.
On the R3271A, press the **CENTER FREQ** and **↑** keys.
At each new frequency, repeat steps (27) through (29), rotating the CAL FACTOR switch to the power sensor's calibration factor.

[Frequency Response (R3271A:233 to 26.5 GHz Band)]

- (31) Set the R3271A **CENTER FREQ** to 23.4 GHz.
- (32) Set the sweeper **CW** to 23.4 GHz.
- (33) On the R3271A, press MARKER **ON** **NEXT MENU** **PRESELE** **PEAK SEARCH** **AUTO PEAKING**.
Wait for the "peaking!!" message to disappear.
- (34) Adjust the sweeper POWER LEVEL for an R3271A MKR amplitude reading of -10 dBm ± 0.09 dB.

- (34) Adjust the sweeper POWER LEVEL for an R3271A MKR amplitude reading of -10 dBm ± 0.09 dB.
- (35) Record the reverse sign value of the power ratio displayed on the power meter in Table 4-22.
- (36) On the sweeper, press the **CW** and **↑** keys.
On the R3271A, press the **CENTER FREQ** and **↑** keys.
At each new frequency, repeat steps (33) through (35), rotating the CAL FACTOR switch to the power sensor's calibration factor.
When the peak is out of CRT display, adjust the **CW** VERNIER of the sweeper for near the center.

[Test Results]

(37) Frequency Response (R3265A/3271A:100 Hz to 3.6 GHz Band)

- ① Enter the most positive number from Table 4-18, HP436A Reading : _____ dB
The absolute value of this number should be less than 5 dB.
- ② Enter the most negative number from Table 4-18, HP436A Reading: _____ dB
The absolute value of this number should be less than 5 dB.
- ③ Subtract ② from ①: _____ dB
The result should be less than 3 dB.

(38) Frequency Response (R3265A/3271A:50 MHz to 2.6 GHz Band)

- ① Enter most positive number from Table 4-18, HP436A Reading within the range of 100 MHz to 2.6 GHz frequency: _____ dB
- ② Enter most negative number from Table 4-18, HP436A Reading within the range of 100 MHz to 2.6 GHz frequency: _____ dB
- ③ Subtract ② from ①: _____ dB
The result should be less than 2 dB.

(39) Frequency Response (R3265A/3271A:3.5 GHz to 7.5 GHz Band)

① Enter the most positive number from Table 4-19, HP436A Reading: _____ dB
The absolute value of this number should be less than 5 dB.

② Enter the most negative number from Table 4-19, HP436A Reading: _____ dB
The absolute value of this number should be less than 5 dB.

③ Subtract ② from ①: _____ dB
The result should be less than 3 dB.

(40) Frequency Response (R3265A:7.5 to 8 GHz Band)(R3271A:7.5 to 15.4 GHz Band)

① Enter the most positive number from Table 4-20, HP436A Reading: _____ dB
The absolute value of this number should be less than 5 dB.

② Enter the most negative number from Table 4-20, HP436A Reading: _____ dB
The absolute value of this number should be less than 5 dB.

③ Subtract ② from ①: _____ dB
The result should be less than 7 dB (R3265A:3 dB).

(41) Frequency Response (R3271A:15.4 to 23.3 GHz Band)

① Enter the most positive number from Table 4-21, HP436A Reading: _____ dB
The absolute value of this number should be less than 5 dB.

② Enter the most negative number from Table 4-21, HP436A Reading: _____ dB
The absolute value of this number should be less than 5 dB.

③ Subtract ② from ①: _____ dB
The result should be less than 8 dB.

(42) Frequency Response (R3271A:23.3 to 26.5 GHz Band)

① Enter the most positive number from Table 4-22, HP436A Reading: _____ dB
The absolute value of this number should be less than 5 dB.

② Enter the most negative number from Table 4-22, HP436A Reading: _____ dB
The absolute value of this number should be less than 5 dB.

③ Subtract ② from ①: _____ dB
The result should be less than 8 dB.

Table 4-18 Frequency Response
(R3265A/3271A : 100 Hz to 3.6 GHz Band)

Column 1	Column 2	Column 3
Frequency (MHz)	HP436A Reading (dB)	CAL Factor Freq. (GHz)
100		0.05
200		0.05
300		0.05
400		0.05
500		0.05
600		0.05
700		0.05
800		0.05
900		0.05
1000		0.05
1100		2.0
1200		2.0
1300		2.0
1400		2.0
1500		2.0
1600		2.0
1700		2.0
1800		2.0
1900		2.0
2000		2.0
2100		2.0
2200		2.0
2300		2.0
2400		2.0
2500		3.0
2600		3.0
2700		3.0
2800		3.0
2900		3.0
3000		3.0
3100		3.0
3200		3.0
3300		3.0
3400		3.0
3500		3.0

Table 4-19 Frequency Response
 (R3265A/3271A : 3.6 GHz to 7.5 GHz Band)

Column 1	Column 2	Column 3
Frequency (GHz)	HP436A Reading (dB)	CAL Factor Freq. (GHz)
3.6		4.0
3.7		4.0
3.8		4.0
3.9		4.0
4.0		4.0
4.1		4.0
4.2		4.0
4.3		4.0
4.4		4.0
4.5		5.0
4.6		5.0
4.7		5.0
4.8		5.0
4.9		5.0
5.0		5.0
5.1		5.0
5.2		5.0
5.3		5.0
5.4		5.0
5.5		6.0
5.6		6.0
5.7		6.0
5.8		6.0
5.9		6.0
6.0		6.0
6.1		6.0
6.2		6.0
6.3		6.0
6.4		6.0
6.5		7.0
6.6		7.0
6.7		7.0
6.8		7.0
6.9		7.0
7.0		7.0
7.1		7.0
7.2		7.0
7.3		7.0
7.4		7.0

Table 4-20 Frequency Response
(R3265A : 7.5 GHz to 8 GHz Band)
(R3271A : 7.5 GHz to 15.4 GHz Band)

Column 1	Column 2	Column 3
Frequency (GHz)	HP436A Reading (dB)	CAL Factor Freq. (GHz)
7.5		8.0
7.7		8.0
7.9		8.0
<R3271A		
Only >		8.0
8.1		8.0
8.3		9.0
8.5		9.0
8.7		9.0
8.9		9.0
9.1		9.0
9.3		10.0
9.5		10.0
9.7		10.0
9.9		10.0
10.1		10.0
10.3		11.0
10.5		11.0
10.7		11.0
10.9		11.0
11.1		11.0
11.3		12.0
11.5		12.0
11.7		12.0
11.9		12.0
12.1		12.0
12.3		13.0
12.5		13.0
12.7		13.0
12.9		13.0
13.1		13.0
13.3		14.0
13.5		14.0
13.7		14.0
13.9		14.0
14.1		14.0
14.3		15.0
14.5		15.0
14.7		15.0
14.9		15.0
15.1		15.0
15.3		15.0

Table 4-21 Frequency Response
(R3271A : 15.4 GHz to 23.3 GHz Band)

Column 1	Column 2	Column 3
Frequency (GHz)	HP436A Reading (dB)	CAL Factor Freq. (GHz)
15.4		15.0
15.6		16.0
15.8		16.0
16.0		16.0
16.2		16.0
16.4		16.0
16.6		17.0
16.8		17.0
17.0		17.0
17.2		17.0
17.4		17.0
17.6		18.0
17.8		18.0
18.0		18.0
18.2		18.0
18.4		18.0
18.6		19.0
18.8		19.0
19.0		19.0
19.2		19.0
19.4		19.0
19.6		20.0
19.8		20.0
20.0		20.0
20.2		20.0
20.4		20.0
20.6		21.0
20.8		21.0
21.0		21.0
21.2		21.0
21.4		21.0
21.6		22.0
21.8		22.0
22.0		22.0
22.2		22.0
22.4		22.0
22.6		23.0
22.8		23.0
23.0		23.0
23.2		23.0

Table 4-22 Frequency Response
(R3271A : 23.3 GHz to 26.5 GHz Band)

Column 1	Column 2	Column 3
Frequency (GHz)	HP436A Reading (dB)	CAL Factor Freq. (GHz)
23.4		23.0
23.6		24.0
23.8		24.0
24.0		24.0
24.2		24.0
24.4		24.0
24.6		25.0
24.8		25.0
25.0		25.0
25.2		25.0
25.4		25.0
25.6		26.0
25.8		26.0
26.0		26.0
26.2		26.0
26.4		26.0

4.4.16 IF Gain Uncertainty

- SPECIFICATION

IF Gain Uncertainty:

- < ± 0.5 dB, reference levels 0 dBm to -50 dBm with 10 dB input attenuation
- < ± 0.7 dB, reference levels 0 dBm to -80 dBm with 10 dB input attenuation

- RELATED ADJUSTMENT

IF amplitude adjustment.

- DESCRIPTION

This test measures IF gain error in resolution band width 1 MHz, 3 kHz and 300 kHz. The input signal level is decreased as the spectrum analyzer's reference level is decreased (IF gain increased). Since the signal level is decreased in precise steps, any error between the reference level and the signal level is caused by the analyzer's IF gain. The frequency synthesizer is phase-locked to the analyzer's 10 MHz reference.

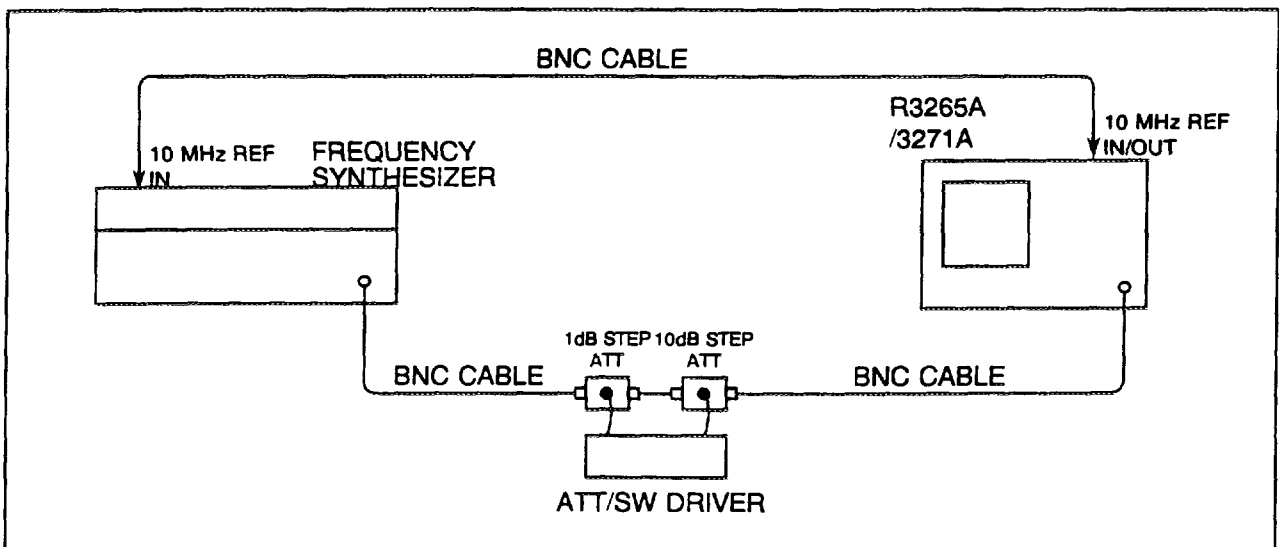

Figure 4-15 IF Gain Uncertainty Test Setup

- EQUIPMENT

Frequency Synthesizer	HP3325B
1 dB Step Attenuator	HP8494H
10 dB Step Attenuator	HP8495H
Attenuator/Switch Driver	HP11713A

● PROCEDURE

(1) Connect the equipment as shown in Figure 4-15.

(2) Set the frequency synthesizer controls as follows:

Freq	11 MHz
Amplitude	- 5 dBm

(3) On the R3265A/3271A, press the PRESET key and set the controls as follows:

Center Freq	11 MHz
Freq Span	0 Hz
dB/div	1 dB
VBW	1 Hz
RBW	1 MHz

(4) Set 1 dB and 10 dB step attenuator to 0 dB. Set the output level of the frequency synthesizer to the value 5 dB lower than the R3265A/3271A reference level.

(5) After several sweeps in the R3265A/3271A, press the A VIEW
A and PEAK keys to read the data on the screen and record it as the reference value. Then, press the ON ,

MKR , B keys and WRITE
B .

(6) Press the 1 dB step attenuator to lower the R3265A/3271A reference level by 1 dB.

(7) After several sweeps in the R3265A/3271A, press the PEAK key to read the marker level on the screen and record it in Table 4-23.

(8) Repeat steps (6) and (7) until the 1 dB step attenuator is lowered to 10 dB.

(9) Press the 10 dB step attenuator to lower the R3265A/3271A reference level by 10 dB.

(10) After several sweeps in the R3265A/3271A, press the PEAK key to read the data on the screen and record it in Table 4-23.

(11) Repeat steps (9) and (10) until the 10 dB attenuator is lowered to 60 dB.

(12) Repeat steps (2) to (11) above for the R3265A/3271A resolution band width 3 kHz and 300 kHz. For resolution band width 3 kHz, repeat steps (11) until the 10 dB step attenuator is lowered to 70 dB and record the result in Table 4-24. For resolution band width 300 kHz, set dB/div to 0.5 dB/div in step (3) and record the result in Table 4-25.

Table 4-23 IF Gain Error (RBW = 1 MHz, 1 dB/div.)

R3265A /3271A Reference Level (dBm)	1 dB Step Attenuator Attenuation (dB)	10 dB Step Attenuator Attenuation (dB)	Reference value (dBm)	
			Δ Marker Level (dB)	Specification
0	0	0	0 (Ref.)	—
-1	1	0		± 0.5 dB
-2	2	0		± 0.5 dB
-3	3	0		± 0.5 dB
-4	4	0		± 0.5 dB
-5	5	0		± 0.5 dB
-6	6	0		± 0.5 dB
-7	7	0		± 0.5 dB
-8	8	0		± 0.5 dB
-9	9	0		± 0.5 dB
-10	10	0		± 0.5 dB
-20	10	10		± 0.5 dB
-30	10	20		± 0.5 dB
-40	10	30		± 0.5 dB
-50	10	40		± 0.5 dB
-60	10	50		± 0.7 dB
-70	10	60		± 0.7 dB

Table 4-24 IF Gain Error (RBW = 3 kHz, 1 dB/div.)

R3265A /3271A Reference Level (dBm)	1 dB Step Attenuator Attenuation (dB)	10 dB Step Attenuator Attenuation (dB)	Reference value (dBm)	
			Δ Marker Level (dB)	Specification
0	0	0	0 (Ref.)	—
-1	1	0		± 0.5 dB
-2	2	0		± 0.5 dB
-3	3	0		± 0.5 dB
-4	4	0		± 0.5 dB
-5	5	0		± 0.5 dB
-6	6	0		± 0.5 dB
-7	7	0		± 0.5 dB
-8	8	0		± 0.5 dB
-9	9	0		± 0.5 dB
-10	10	0		± 0.5 dB
-20	10	10		± 0.5 dB
-30	10	20		± 0.5 dB
-40	10	30		± 0.5 dB
-50	10	40		± 0.5 dB
-60	10	50		± 0.7 dB
-70	10	60		± 0.7 dB
-80	10	70		± 0.7 dB

Table 4-25 IF Gain Error (RBW = 300 kHz, 0.5 dB/div.)

R3265A /3271A Reference Level (dBm)	1 dB Step Attenuator Attenuation (dB)	10 dB Step Attenuator Attenuation (dB)	Reference value (dBm)	
			Marker Level (dB)	Specification
0	0	0	0 (Ref.)	—
-1	1	0		± 0.5 dB
-2	2	0		± 0.5 dB
-3	3	0		± 0.5 dB
-4	4	0		± 0.5 dB
-5	5	0		± 0.5 dB
-6	6	0		± 0.5 dB
-7	7	0		± 0.5 dB
-8	8	0		± 0.5 dB
-9	9	0		± 0.5 dB
-10	10	0		± 0.5 dB
-20	10	10		± 0.5 dB
-30	10	20		± 0.5 dB
-40	10	30		± 0.5 dB
-50	10	40		± 0.5 dB
-60	10	50		± 0.7 dB
-70	10	60		± 0.7 dB

4.4.17 Scale Fidelity

- SPECIFICATION

Log Scale Fidelity: ± 0.2 dB/1 dB,

± 1 dB/10 dB to a maximum of ± 1.5 dB over 0 to 90 dB range.

Linear Scale Fidelity: $< \pm 5\%$ of reference level

QP-mode Log Scale Fidelity: ± 1.0 dB/30 dB, ± 2 dB/40 dB, ± 1.0 dB/40 dB (25°C $\pm 10^\circ$ C)

- RELATED ADJUSTMENT

IF amplitude adjustment.

- DESCRIPTION

This test measures display accuracy for 1 dB, 10 dB log scales, X1, X2 linear scales and 10 dB QP mode log scale. All scales are measured with 0 dBm reference signal. Figure 4-16 illustrates the measurement system of this test. The frequency synthesizer is phase-locked to the 10 MHz reference source of the spectrum analyzer.

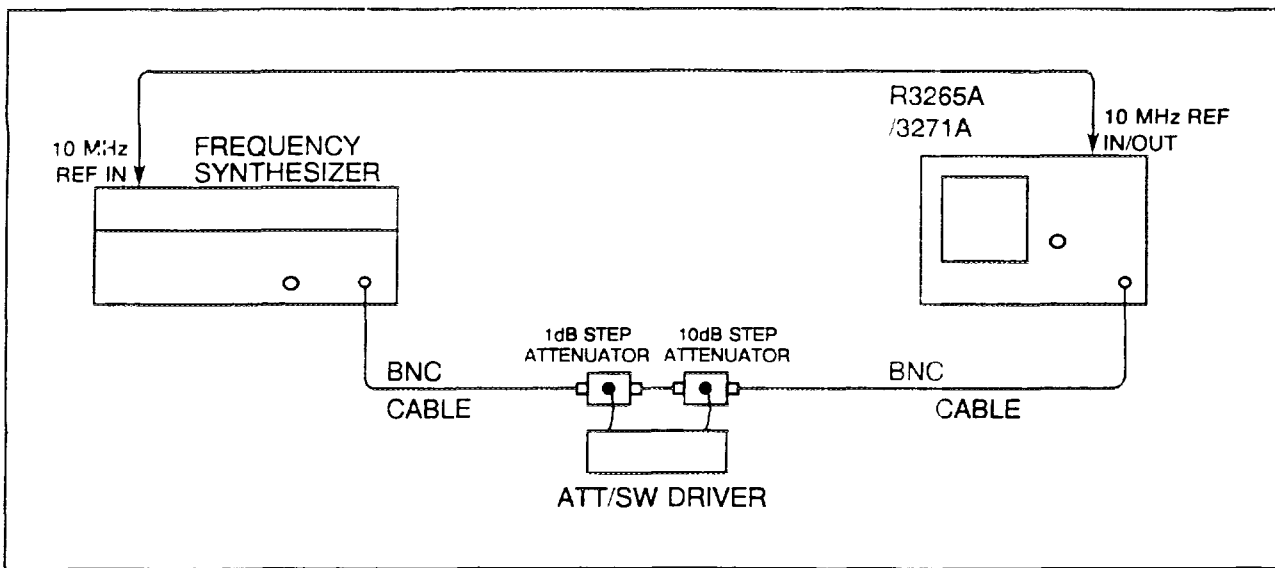

Figure 4-16 Scale Fidelity Test Setup

- EQUIPMENT

Frequency Synthesizer	HP3325B
1 dB Step Attenuator	HP8494H
10 dB Step Attenuator	HP8495H
Attenuator/Switch Driver	HP11713A

● PROCEDURE

- (1) Connect the equipment as shown in Figure 4-16.
- (2) Set the frequency synthesizer controls as follows:

Freq	11 MHz
Amplitude	0 dBm

- (3) On the R3265A/3271A, press the PRESET key and set the controls as follows:

Center Freq	11 MHz
Freq Span	0 Hz
Ref Level	0 dBm
RBW	1 MHz
VBW	1 Hz
dB/div	1 dB/div

- (4) Set the 1 dB and 10 dB step attenuators to 0 dB.

- (5) On the R3265A/3271A, press the PEAK key, NEXT MENU and set CONT PK ON/OFF to ON.

[1 dB/div Log Scale]

- (6) On the frequency synthesizer, adjust the amplitude until the R3265A/3271A marker reads exactly 0.00 dBm.

- (7) On the R3265A/3271A, press the MENU key, SWEEP MODE, SINGLE SWP.

- (8) Lower the frequency synthesizer level by 1 dB.

- (9) On the R3265A/3271A, press the MENU key, SWEEP MODE, SINGLE SWP and SINGLE SWP.

- (10) Record the marker level in Table 4-26. Calculate the incremental error according to the following equation and record the result in the Incremental Error column in Table 4-26.
Incremental error = (Current marker level) - (Previous marker level) + 1 dB

- (11) Repeat steps (8) to (10) until the frequency synthesizer level is set to the value 10 dB lower than the initially set level.

[10 dB/div Log Scale]

- (12) On the P3265A/3271A, press the **MENU**, **SWEEP MODE** and **CONT SWP** keys set **REF LEVEL** and **dB/div** to 10 dB/div. Set the resolution band width to 3 kHz.
- (13) Set the frequency synthesizer level so that the R3265A/3271A marker indicates just 0.00 dBm.
- (14) Lower the frequency synthesizer level by 10 dB. If the level cannot be lowered by 10 dB, use the 10 dB step attenuator to lower it by 10 dB.
- (15) On the R3265A/3271A, press the **MENU**, **SWEEP MODE**, **SINGLE SWP** and **SINGLE SWP** keys.
- (16) Record the marker level in Table 4-27. Calculate the incremental error from the following expression and record the result in the Incremental Error column in Table 4-27.
 Incremental error = (Current marker level) - (Previous marker level) + 10 dB
- (17) Repeat steps (14) to (16) until the frequency synthesizer level is set to the value 90 dB lower than the initially set level.

Table 4-26 1 dB/div. Log Scale Fidelity (RBW = 1 MHz)

Input Signal Level (dBm, nominal)	dB from Reference Level (nominal)	Δ Marker Level			Incremental Error (dB)
		Min. (dBm)	Actual (dBm)	Max. (dBm)	
0	0	0	0 (Ref.)	0	0 (Ref.)
-1	-1	-1.2		-0.8	
-2	-2	-2.2		-1.8	
-3	-3	-3.2		-2.8	
-4	-4	-4.2		-3.8	
-5	-5	-5.2		-4.8	
-6	-6	-6.2		-5.8	
-7	-7	-7.2		-6.8	
-8	-8	-8.2		-7.8	
-9	-9	-9.2		-8.8	
-10	-10	-10.2		-9.8	

Table 4-27 10 dB/div. Log Scale Fidelity (RBW = 3 kHz)

Input Signal Level (dBm, nominal)	dB from Reference Level (nominal)	Δ Marker Level			Incremental Error (dB)
		Min. (dBm)	Actual (dBm)	Max. (dBm)	
0	0	0	0 (Ref.)	0	0 (Ref.)
-10	-10	-11		-9	
-20	-20	-21		-19	
-30	-30	-31		-29	
-40	-40	-41		-39	
-50	-50	-51		-49	
-60	-60	-61		-59	
-70	-70	-71		-69	
-80	-80	-81		-79	
-90	-90	-91		-89	

[Linear Scale]

(18) Set the frequency synthesizer as follows:

Freq	11 MHz
Amplitude	0 dBm

Set the 1 dB and 10 dB attenuator to 0 dB.

(19) On the R3265A/3271A, press the **PRESET** key and set the controls as follows:

Center Freq	11 MHz
Freq Span	10 kHz
Ref Level	0 dBm
RBW	1 kHz
VBW	1 kHz
ATT	20 dB

(20) On the R3265A/3271A, press the **REF LEVEL** , **LINEAR** and **X1** keys to select the linear X1 mode. Then, press the **PEAK** , **NEXT MENU** and **CONT PK ON/OFF** keys to set the continuous peak search mode.

(21) Precisely set the frequency synthesizer level to the R3265A/3271A reference level while reading the marker level on the screen.

(22) On the R3265A/3271A, press the **MENU** , **SWEEP MODE** and **SINGLE SWP** keys to set the single sweep mode.

(23) Read the level value displayed on the frequency synthesizer and set the value as the reference value (Ref). Then, set the frequency synthesizer level to the value 0.92 dB lower than the reference value.

(24) On the R3265A/3271A, perform single sweep twice, read the marker level and record it in Table 4-28.

(25) Set the frequency synthesizer level as shown in the input Signal Level column in Table 4-28 sequentially and repeat step (24) for each.

Table 4-28 Linear Scale Fidelity (X1)

Input Signal Level		Div. from Reference Level	Δ Marker Level		
(dB, nominal)	(mV, nominal)		Min. (mV)	Actual (mV)	Max. (mV)
0 (Ref.)	223.6	0	223.6	223.6 (Ref.)	223.6
-0.92	201.24	1	191.2		211.3
-1.94	178.88	2	169.9		187.8
-3.10	156.52	3	148.7		164.3
-4.44	134.16	4	127.5		140.8
-6.02	111.8	5	106.2		117.3
-7.96	89.44	6	85.0		93.9
-10.46	67.08	7	63.8		70.4
-13.98	44.72	8	42.5		46.9
-20	22.36	9	21.3		23.4

Table 4-29 QP-mode Log Scale Fidelity

Input Signal Level (dBm, nominal)	dB from Reference Level (dB, nominal)	Δ Marker Level		
		Min. (dBm)	Actual (dBm)	Max. (dBm)
0 (Ref.)	0	0	0 (Ref.)	0
-10	-10	-11		-9
-20	-20	-21		-19
-30	-30	-31		-29
-40	-40	-41*		-39**

*: -42 dBm when the ambient temperature is out of range 25°C ± 10°C.

** : -38 dBm when the ambient temperature is out of range 25°C ± 10°C.

[QP-mode Log Scale]

(26) Set the frequency synthesizer as follows:

Freq 11 MHz
Amplitude 0 dBm

Set the 1dB and 10dB attenuator to 0dB.

(27) On the R3265A/3271A, press the **PRESET** key and set the controls as follows:

Center Freq 11 MHz
Freq Span 0 Hz

(28) On the R3265A/3271A, press the **SHIFT**, **EMC 1**, **QP** keys to set the QP mode.

Then, press the **PEAK**, **NEXT MENU** and **CONT PK ON/OFF** keys to set the continuous peak search mode.

(29) Precisely set the frequency synthesizer level to the R3265A/3271A reference level.

(30) On the R3265A/3271A, press the **A**, **VIEW A**, **MARKER ON** and **△MKR** keys.

Then, press the **B** key and **WRITE B**.

(31) Lower the frequency synthesizer level by 10 dB. After (2) to (3) seconds, read the **△** marker level on the screen and record it in Table 4-29.

(32) Repeat step (31) until the frequency synthesizer level is set to the value 40 dB lower than the level set in step (29).

4.4.18 Input Attenuator Accuracy

- SPECIFICATION

Input attenuator accuracy (referenced to 10 dB input attenuation, for 20 to 70 dB settings):

R3265A: 100 Hz to 8 GHz: < ± 1.1 dB/10 dB step to a maximum of ± 2.0 dB

R3271A: { 100 Hz to 12.4 GHz: < ± 1.1 dB/10 dB step to a maximum of ± 2.0 dB
 { 12.4 GHz to 18 GHz: < ± 1.3 dB/10 dB step to a maximum of ± 2.5 dB
 { 18 GHz to 26.5 GHz: < ± 1.8 dB/10 dB step to a maximum of ± 3.5 dB

- RELATED ADJUSTMENT

There is no related adjustment procedure for this performance test.

- DESCRIPTION

This test measures the input attenuator's switching accuracy over the full 70 dB.

The number of frequency measured points is one point at 4 GHz for the R3265A, and three points at 4 GHz, 15 GHz and 18 GHz for the R3271A.

The synthesized sweeper is phase-locked to the spectrum analyzer's 10 MHz reference. The input attenuator switching accuracy is referenced to the 10 dB attenuator setting. Step-to-step accuracy is calculated from switching accuracy data.

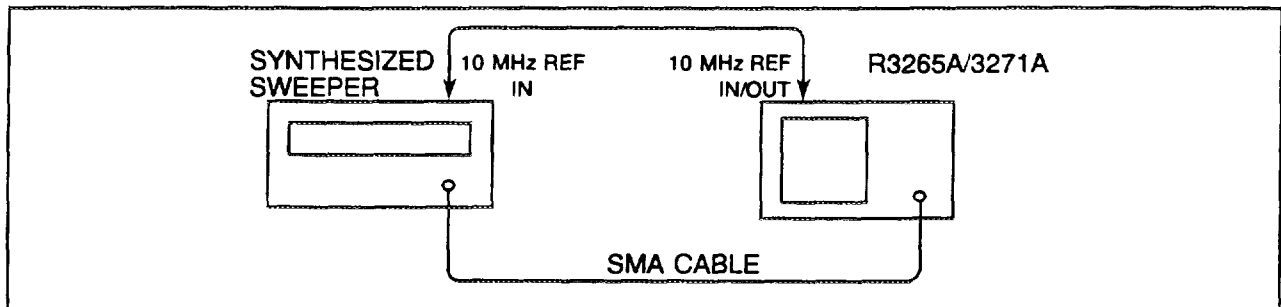

Figure 4-17 Input Attenuator Switching Accuracy Test Setup

- EQUIPMENT

Synthesized Sweeper :

Frequency Range: 10 MHz to 18 GHz

(Critical Specifications for Equipment Substitution)

TR4515

(Recommended model)

• PROCEDURE

- (1) IF gain uncertainty is measured when the resolution bandwidth is set to 3kHz and the result is filled in on the IF Gain uncertainty of Table 4-30.
For the test method, refer to "4.4.16 IF Gain Uncertainty".

CAUTION

Measure IF gain uncertainty when the resolution bandwidth is set to 3kHz before doing this test. IF gain uncertainty is included in the measurement result because of IF gain's changing and measuring in this test.

- (2) Connect the equipment as shown in Figure 4-17.
(3) Set the synthesized generator controls as follows:

Freq	4 GHz
Amplitude	-5 dBm

- (4) On the R3265A/3271A, press the PRESET key and set the controls as follows:

Center Freq	4 GHz
Freq Span	10 kHz
Ref Level	0 dBm
dB/div	1 dB/div
RBW	3 kHz
VBW	10 Hz
SWP	1 sec

- (5) On the synthesized generator, adjust the POWER LEVEL to place the peak of the signal five divisions below the R3265A/3271A reference level.

- (6) On the R3265A/3271A, press the MENU key, SWEEP
MODE, SINGLE
SWP and SINGLE
SWP.

Press the PEAK key, read the MKR level and record it in Table 4-30 as the reference value.

- (7) On the R3265A/3271A, press the CPL, ATT and * keys.

- (8) On the R3265A/3271A, press the **MENU** key, **SWEEP MODE**, **SINGLE SWP** and **SINGLE SWP**.

Press the **PEAK** key, read the MKR level. The marker level measured here is subtracted from the reference value measure in the (6).

IF gain uncertainty measured in the (1) is subtracted from the value.

Records it in Table 4-29 as Actual MKR Reading.

$$\text{Actual MKR Reading} = \boxed{\text{Reference value measured in the (6)}} - \boxed{\text{Marker level measured in the (9)}} - \boxed{\text{IF gain uncertainty measured in the (1)}}$$

- (9) Repeat steps (7) and (8) for the remaining R3265A/3271A ATT setting listed in Table 4-30.
- (10) Calculate the step-to-step accuracy as described in the following steps and record the results in Table 4-30. Step-to-step accuracy should be within the limits shown in Table 4-30.

[Step-to-Step Accuracy Calculation]

- (11) For the 20 dB ATT setting, switching accuracy becomes step-to-step accuracy.
- (12) For the 30, 40, 50, 60 and 70 dB ATT settings, subtract the 10dB down ATT switching accuracy from the current ATT switching accuracy.
- (13) Center Frequency is changed to 15GHz and 18GHz and the operations in (2) to (12) are executed for R3271A. Fill in the value measured in the (1) when Center Frequency is 4GHz on the IF Gain Uncertainty Table 4-30.

Table 4-30 Input Attenuator Accuracy

[R3265A] Center Frequency: 4 GHz, Reference value ____ dBm

R3265A Attenuator (dB)	IF Gain (dB)	IF Gain Uncertainty (dB)	Switching Accuracy			Step-to-Step Accuracy	
			Min. (dB)	Actual (dB)	Max. (dB)	Actual (dB)	Spec. (dB)
10	0	0	0 (Ref.)	0 (Ref.)	0 (Ref.)	0 (Ref.)	0 (Ref.)
20	10		-2		+2		± 1.1
30	20		-2		+2		± 1.1
40	30		-2		+2		± 1.1
50	40		-2		+2		± 1.1
60	50		-2		+2		± 1.1
70	60		-2		+2		± 1.1

[R3271A] Center Frequency: 4 GHz, Reference value ____ dBm

R3271A Attenuator (dB)	IF Gain (dB)	IF Gain Uncertainty (dB)	Switching Accuracy			Step-to-Step Accuracy	
			Min. (dB)	Actual (dB)	Max. (dB)	Actual (dB)	Spec. (dB)
10	0	0	0 (Ref.)	0 (Ref.)	0 (Ref.)	0 (Ref.)	0 (Ref.)
20	10		-2		+2		± 1.1
30	20		-2		+2		± 1.1
40	30		-2		+2		± 1.1
50	40		-2		+2		± 1.1
60	50		-2		+2		± 1.1
70	60		-2		+2		± 1.1

[R3265A] Center Frequency: 15 GHz, Reference value ____ dBm

R3265A Attenuator (dB)	IF Gain (dB)	IF Gain Uncertainty (dB)	Switching Accuracy			Step-to-Step Accuracy	
			Min. (dB)	Actual (dB)	Max. (dB)	Actual (dB)	Spec. (dB)
10	0	0	0 (Ref.)	0 (Ref.)	0 (Ref.)	0 (Ref.)	0 (Ref.)
20	10		-2.5		+2.5		± 1.3
30	20		-2.5		+2.5		± 1.3
40	30		-2.5		+2.5		± 1.3
50	40		-2.5		+2.5		± 1.3
60	50		-2.5		+2.5		± 1.3
70	60		-2.5		+2.5		± 1.3

[R3271A] Center Frequency: 15 GHz, Reference value ____ dBm

R3271A Attenuator (dB)	IF Gain (dB)	IF Gain Uncertainty (dB)	Switching Accuracy			Step-to-Step Accuracy	
			Min. (dB)	Actual (dB)	Max. (dB)	Actual (dB)	Spec. (dB)
10	0	0	0 (Ref.)	0 (Ref.)	0 (Ref.)	0 (Ref.)	0 (Ref.)
20	10		-3.5		+3.5		± 1.8
30	20		-3.5		+3.5		± 1.8
40	30		-3.5		+3.5		± 1.8
50	40		-3.5		+3.5		± 1.8
60	50		-3.5		+3.5		± 1.8
70	60		-3.5		+3.5		± 1.8

4.4.19 Sweep Time Accuracy

- SPECIFICATION

For Span = 0 Hz

Sweep Time $\leq \pm 3\%$

- RELATED ADJUSTMENT

There is no related adjustment procedure for this performance test.

- - DESCRIPTION

A low frequency signal (Square Wave) is displayed on the R3265A/3271A Spectrum Analyzer in ZERO Span mode, and measure the frequency of the displayed signal.

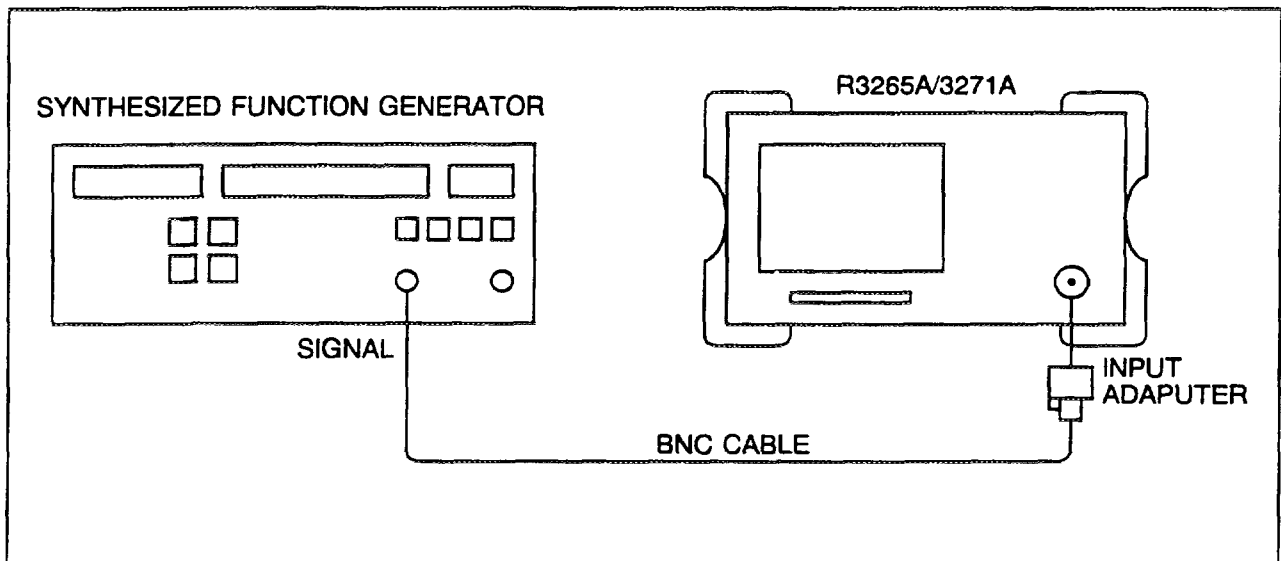

Figure 4-18 Sweep Time Accuracy Test Setup

- EQUIPMENT

Synthesized Function Generator HP3325A

Adapters:

Type N(m)to-BNC(f) JCF-AF00IEXO3

Cable:

BNC, 150 cm MI-09

● PROCEDURE

- (1) Connect the equipment as shown in Figure 4-18 using the BNC cable from the HP3325A SIGNAL OUT.

Connected it to the R3265A/3271A INPUT.

- (2) On the R3265A/3271A, press the **PRESET** key and set the controls as follows:

Center Freq	0 MHz
Span	0 MHz
Sweep Time	50 μ s
dB/div	1 dB/div

- (3) On the HP3325A, set the controls as follows:

Frequency	22 kHz
Amplitude	- 10 dBm
Function	Square

- (4) On the R3265A/3271A, press **MENU** key, set **TRIG** and **VIDEO**, and adjust with the knob to trigger with VIDEO. And press the **MENU** key, **SWEEP MODE**, **SINGLE** and **SINGLE**.

Wait for the sweeper stops.

- (5) On the R3265A/3271A, press the **MARKER ON** key. Set the marker at the second rising edge from left.

Record the Marker time as the Measured Sweep Time in Table 4-31 for the 50 μ s Sweep Time setting.

The Measured Sweep Time should be within the limits shown in Table 4-31.

- (6) Repeat step (5) for the HP3325A frequencies and R3265A/3271A sweep times as indicated in Table 4-31.

Table 4-31 Sweep Time Accuracy

HP3325A Frequency	R3265A /3271A Sweep Time Setting	Marker Reading		
		Min.	Actual	Max.
22 kHz	50 μ s	44.1 μ s		46.8 μ s
11 kHz	100 μ s	88.2 μ s		93.6 μ s
5.5 kHz	200 μ s	177 μ s		187 μ s
2.2 kHz	500 μ s	441 μ s		468 μ s
1.1 kHz	1 ms	882 μ s		936 μ s
550 Hz	2 ms	1.77 ms		1.87 ms
220 Hz	5 ms	4.41 ms		4.68 ms
110 Hz	10 ms	8.82 ms		9.36 ms
55 Hz	20 ms	17.7 ms		18.7 ms
22 Hz	50 ms	44.1 ms		46.8 ms
11 Hz	100 ms	88.2 ms		93.6 ms
5.5 Hz	200 ms	177 ms		187 ms
2.2 Hz	500 ms	441 ms		468 ms
1.1 Hz	1 s	882 ms		936 ms
0.55 Hz	2 s	1.77 s		1.87 s
0.22 Hz	5 s	4.41 s		4.68 s
0.11 Hz	10 s	8.82 s		9.36 s
0.055 Hz	20 s	17.7 s		18.7 s
0.022 Hz	50 s	44.1 s		46.8 s
0.011 Hz	100 s	88.2 s		93.6 s

4.4.20 Calibration Amplitude Accuracy

• SPECIFICATION

Amplitude: - 10 dBm ± 0.3 dB

• RELATED ADJUSTMENT

Calibration amplitude adjustment.

• DESCRIPTION

The amplitude accuracy of the CALOUT signal are checked for - 10 dBm ± 0.3 dBm.

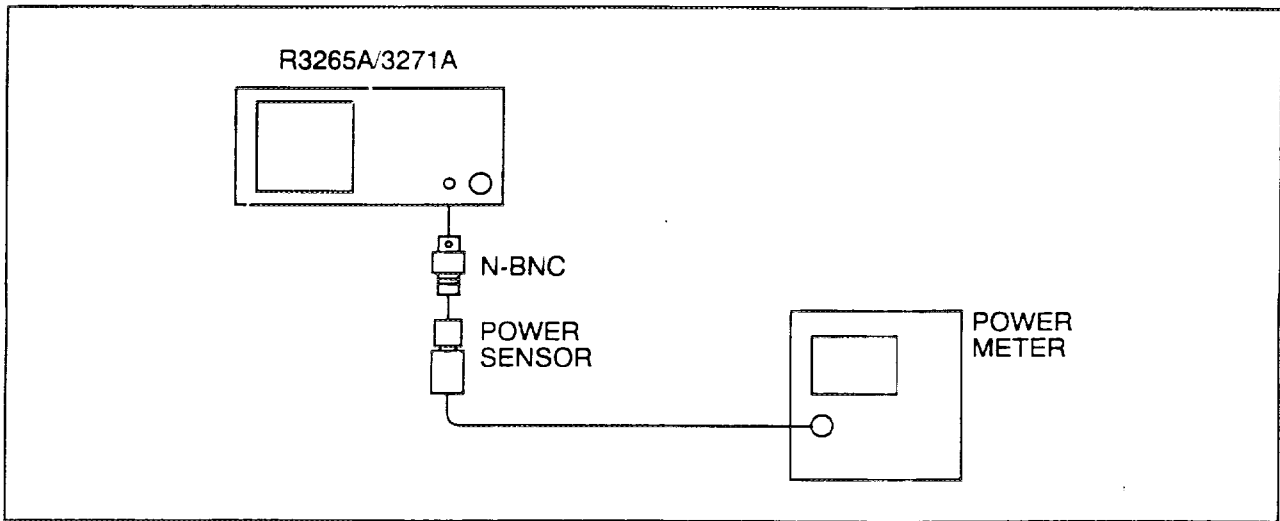

Figure 4-19 Calibration Amplitude Accuracy Test Setup

• EQUIPMENT

Power Meter	HP436A
Power Sensor	HP8481A

• PROCEDURE

- (1) Connect the equipment as shown in Figure 4-19.
- (2) Press the power sensor zero of the power meter and calibrate the power sensor. Enter the power sensor's 25 MHz calibration factor into the power meter.
- (3) Connect the power sensor via an N(f) – BNC(m) adapter directly to the CALOUT connector. Read the power meter display. The power level should be within the following limits (± 0.3 dB):

$$- 10.3 \text{ dBm} \leq \text{Actual} \leq - 9.7 \text{ dBm}$$

4.5 Checklist/Data Form

File No. : _____ Description : SPECTRUM ANALYZER
 UUT MFR : ADVANTEST CO. ID No. : _____
 Model : R3265A/3271A Date : _____

Table 4-32 Performance Test Record (1 of 12)

Para. No.	Test Description	Results		
		Min.	Actual	Max.
1	Frequency Readout Accuracy and Frequency Counter Marker Accuracy			
	2.0 GHz CENTER FREQ			
	1 MHz SPAN	1.99994829 GHz		2.00005171 GHz
	10 MHz SPAN	1.99968479 GHz		2.00031521 GHz
	20 MHz SPAN	1.99935479 GHz		2.00064521 GHz
	50 MHz SPAN	1.99845479 GHz		2.00154521 GHz
	100 MHz SPAN	1.99684979 GHz		2.00315021 GHz
	2 GHz SPAN	1.93954979 GHz		2.06045021 GHz
	5.0 GHz CENTER FREQ			
	1 MHz SPAN	4.99994799 GHz		5.00005201 GHz
	10 MHz SPAN	4.99968449 GHz		5.00031551 GHz
	20 MHz SPAN	4.99935449 GHz		5.00064551 GHz
	50 MHz SPAN	4.99845449 GHz		5.00154551 GHz
	100 MHz SPAN	4.99684949 GHz		5.00315051 GHz
	2 GHz SPAN	4.93954949 GHz		5.06045051 GHz
	<R3271A ONLY>			
	11.0 GHz CENTER FREQ			
	1 MHz SPAN	10.99994739 GHz		11.00005261 GHz
	10 MHz SPAN	10.99968389 GHz		11.00031611 GHz
	20 MHz SPAN	10.99935389 GHz		11.00064611 GHz
	50 MHz SPAN	10.99845389 GHz		11.00154611 GHz
	100 MHz SPAN	10.99684889 GHz		11.00315111 GHz
	2 GHz SPAN	10.93954889 GHz		11.06045111 GHz
	18.0 GHz CENTER FREQ			
	1 MHz SPAN	17.99994669 GHz		18.00005331 GHz
	10 MHz SPAN	17.99968319 GHz		18.00031681 GHz
	20 MHz SPAN	17.99935319 GHz		18.00064681 GHz
	50 MHz SPAN	17.99845319 GHz		18.00154681 GHz
	100 MHz SPAN	17.99684819 GHz		18.00315181 GHz
	2 GHz SPAN	17.93954819 GHz		18.06045181 GHz

Table 4-32 Performance Test Record (2 of 12)

Para. No.	Test Description	Results		
		Min.	Actual	Max.
1	Frequency Readout Accuracy and Frequency Counter Marker Accuracy (cont'd)			
	Frequency Counter Marker Accuracy			
	2.0 GHz CENTER FREQ	1.999999794 GHz		2.000000206 GHz
	5.0 GHz CENTER FREQ	4.999999494 GHz		5.000000506 GHz
	11.0 GHz CENTER FREQ	10.999998889 GHz		11.000001111 GHz
	18.0 GHz CENTER FREQ	17.999998184 GHz		18.000001816 GHz
2	Frequency Reference Output Accuracy			
	10 MHz Reference Frequency	24.9999975 MHz		25.0000025 MHz
3	Residual FM			
	Residual FM			3 Hz
4	Frequency Drift			
	50.1 kHz SPAN			2.5 kHz
	200 Hz SPAN			60 Hz
5	Noise Sidebands			
	2.6 GHz Center Frequency			
	1 kHz Offset			- 100 dBc/Hz
	10 kHz Offset			- 110 dBc/Hz
	100 kHz Offset			- 114 dBc/Hz
	3.7 GHz Center Frequency			
	1 kHz Offset			- 95 dBc/Hz
	10 kHz Offset			- 108 dBc/Hz
100 kHz Offset			- 110 dBc/Hz	

Table 4-32 Performance Test Record (3 of 12)

Para. No.	Test Description	Results		
		Min.	Actual	Max.
6	Frequency Span Accuracy			
	2 GHz Center Frequency			
	20 kHz SPAN	15.2 kHz		16.8 kHz
	50 kHz SPAN	38.0 kHz		42 kHz
	400 kHz SPAN	304 kHz		336 kHz
	2 MHz SPAN	1.52 MHz		1.68 MHz
	2.01 MHz SPAN	1.552 MHz		1.648 MHz
	5 MHz SPAN	3.88 MHz		4.12 MHz
	10 MHz SPAN	7.76 MHz		8.24 MHz
	20 MHz SPAN	15.52 MHz		16.48 MHz
	50 MHz SPAN	38.8 MHz		41.2 MHz
	100 MHz SPAN	77.6 MHz		82.4 MHz
	200 MHz SPAN	155.2 MHz		164.8 MHz
	500 MHz SPAN	388 MHz		412 MHz
	1 GHz SPAN	776 MHz		824 MHz
	2 GHz SPAN	1.552 GHz		1.648 GHz
	4.5 GHz Center Frequency			
	4 GHz SPAN	3.104 GHz		3.296 GHz
	8 GHz SPAN	6.208 GHz		6.592 GHz
	< R3271A ONLY >			
	10 GHz Center Frequency			
	10 MHz SPAN	7.76 MHz		8.24 MHz
	100 MHz SPAN	77.6 MHz		82.4 MHz
	1 GHz SPAN	776 MHz		824 MHz
	2 GHz SPAN	1.552 GHz		1.6484 GHz
	17 GHz Center Frequency			
	10 MHz SPAN	7.76 MHz		8.24 MHz
	100 MHz SPAN	77.6 MHz		82.4 MHz
	1 GHz SPAN	776 MHz		824 MHz
	2 GHz SPAN	1.552 GHz		1.648 GHz
10 GHz Center Frequency				
5 GHz SPAN	3.88 GHz		4.12 GHz	
10 GHz SPAN	7.76 GHz		8.24 GHz	
19 GHz SPAN	15.52 GHz		16.48 GHz	

Table 4-32 Performance Test Record (4 of 12)

Para. No.	Test Description	Results			
		Min.	Actual	Max.	
6	Frequency Span Accuracy (cont'd)				
	LOG Span Accuracy				
	100 MHz Start Frequency				
	200 MHz TR4515 FREQ	179 MHz		221 MHz	
	500 MHz TR4515 FREQ	449 MHz		551 MHz	
	800 MHz TR4515 FREQ	719 MHz		881 MHz	
	10 MHz Start Frequency				
	20 MHz TR4515 FREQ	17 MHz		23 MHz	
	50 MHz TR4515 FREQ	44 MHz		56 MHz	
	80 MHz TR4515 FREQ	71 MHz		89 MHz	
	100 MHz TR4515 FREQ	89 MHz		111 MHz	
	200 MHz TR4515 FREQ	179 MHz		221 MHz	
	500 MHz TR4515 FREQ	449 MHz		551 MHz	
	800 MHz TR4515 FREQ	719 MHz		881 MHz	
	1 MHz Start Frequency				
	10 MHz TR4515 FREQ	8 MHz		12 MHz	
	20 MHz TR4515 FREQ	17 MHz		23 MHz	
	50 MHz TR4515 FREQ	44 MHz		56 MHz	
	80 MHz TR4515 FREQ	71 MHz		89 MHz	
	100 MHz TR4515 FREQ	89 MHz		111 MHz	
	200 MHz TR4515 FREQ	179 MHz		221 MHz	
	500 MHz TR4515 FREQ	449 MHz		551 MHz	
	800 MHz TR4515 FREQ	719 MHz		881 MHz	
	7	Resolution Bandwidth Accuracy and Selectivity			
		Resolution Bandwidth Accuracy			
		3 MHz	2.25 MHz		3.75 MHz
		1 MHz	850 kHz		1.15 MHz
300 kHz		255 kHz		345 kHz	
100 kHz		85 kHz		115 kHz	
30 kHz		25.5 kHz		34.5 kHz	
10 kHz		8.5 kHz		11.5 kHz	
3 kHz		2.55 kHz		3.45 kHz	
1 kHz		850 Hz		1150 Hz	
300 Hz		255 Hz		345 Hz	
100 Hz		85 Hz		115 Hz	
30 Hz		22.5 Hz		37.5 Hz	
100 Hz Digital IF		50 Hz		150 Hz	
30 Hz Digital IF		15 Hz		45 Hz	
10 Hz Digital IF		5 Hz		15 Hz	

Table 4-32 Performance Test Record (5 of 12)

Para. No.	Test Description	Results		
		Min.	Actual	Max.
7	Resolution Bandwidth Accuracy and Selectivity (cont'd)			
	Resolution Bandwidth Selectivity			
	3 MHz			15
	1 MHz			15
	300 kHz			15
	100 kHz			15
	30 kHz			15
	10 kHz			15
	3 kHz			15
	1 kHz			15
	300 Hz			15
	100 Hz			15
	30 Hz			20
	100 Hz Digital IF			5 (nominal)
30 Hz Digital IF			5 (nominal)	
10 Hz Digital IF			5 (nominal)	
8	Resolution Bandwidth Switching Uncertainty			
	3 MHz	-0.3 dB		+0.3 dB
	1 MHz	-0.3 dB		+0.3 dB
	300 kHz	-0.3 dB		+0.3 dB
	100 kHz	-0.3 dB		+0.3 dB
	30 kHz	-0.3 dB		+0.3 dB
	10 kHz	-0.3 dB		+0.3 dB
	3 kHz	-0.3 dB		+0.3 dB
	1 kHz	-0.3 dB		+0.3 dB
	300 Hz	-0.3 dB		+0.3 dB
	100 Hz	-0.3 dB		+0.3 dB
	30 Hz	-1.0 dB		+1.0 dB
	100 Hz Digital IF	-1.5 dB		+1.5 dB
	30 Hz Digital IF	-1.5 dB		+1.5 dB
10 Hz Digital IF	-1.5 dB		+1.5 dB	

Table 4-32 Performance Test Record (6 of 12)

Para. No.	Test Description	Results		
		Min.	Actual	Max.
9	Displayed Average Noise Level < R3265A ONLY > 1 kHz 10 kHz 100 kHz 1MHz 10 MHz 100 MHz 500 MHz 1.0 GHz 1.5 GHz 2.0 GHz 2.5 GHz 3.0 GHz 3.5 GHz 3.5 GHz to 8 GHz 25 MHz (Low Noise) < R3271A ONLY > 1 kHz 10 kHz 100 kHz 1MHz 10 MHz 100 MHz 500 MHz 1 GHz 1.5 GHz 2 GHz 2.5 GHz 3 GHz 3.5 GHz 3.5 GHz to 7.5 GHz 7.5 GHz to 15.4 GHz 15.2 GHz to 23.3 GHz 23 GHz to 26.5 GHz			-95.23 dBm -95.23 dBm -96.23 dBm -120.23 dBm -125.21 dBm -125.27 dBm -124.45 dBm -123.68 dBm -122.90 dBm -122.13 dBm -121.35 dBm -120.58 dBm -119.80 dBm -120.23 dBm -145.00 dBm -95.23 dBm -95.23 dBm -96.23 dBm -120.23 dBm -120.21 dBm -120.07 dBm -119.45 dBm -118.68 dBm -117.90 dBm -117.13 dBm -116.35 dBm -115.58 dBm -114.80 dBm -108.23 dBm -101.23 dBm -101.23 dBm -95.23 dBm

- (3) Press the **PRESET** key of the R3265A/3271A, and set the controls as follows:

CENTER FREQ	25 MHz
SPAN	0 Hz
REF. LEVEL	-5 dBm
SCALE	1 dB/div
RBW	100 kHz

- (4) Make sure that approximately -10 dBm of signals are displayed on the screen.

Then, press the following keys in this sequence.

B, **WRITE B**, **VIEW B**, **MARKER ON**, **NEXT MENU**, **DSP POSI UP/LOW**, **PREV MENU**, **MKR**, **A**.

- (5) Hold down the **SHIFT** key and press the **CAL 7** and **CAL SIG LEVEL** keys to set to the CAL LEVEL to -20 dBm.

- (6) Hold down the **SHIFT** key and press the **BK SP** key to select the DEBUG mode.

Then, press the following keys in this sequence.

4 **2** **0** **0** **2** **0** **ENTER** **3** **D** **ENTER**

- (7) Adjust R122 so that the Δ MARKER value enters within ± 0.1 dB.

- (8) Press the following keys in this sequence.

4 **2** **0** **0** **2** **0** **ENTER** **3** **F** **ENTER** **4** **2** **0** **0** **2** **2** **ENTER** **1** **ENTER**

- (9) Adjust R144 in the same way as for Step (7).

- (10) Press the following keys in this sequence.

4 **2** **0** **0** **2** **2** **ENTER** **2** **ENTER** **4** **2** **0** **0** **0** **4** **ENTER** **1** **1** **ENTER**

- (11) Adjust R338 in the same way as for Step (7)

- (12) Press the following keys in this sequence.

4 **2** **0** **0** **0** **4** **ENTER** **1** **ENTER** **RETURN**

- (13) Set the CAL LEVEL to -30 dBm.

- (14) Hold down the **SHIFT** key and press the **BK SP** key to select the DEBUG mode.

- (15) Press the following keys in this sequence.

4 **2** **0** **0** **2** **0** **ENTER** **3** **B** **ENTER**

5.3.4 IF Step Amp Adjustment

- ASSEMBLY ADJUSTED
IF block (WBL-32xxIF)
- RELATED PERFORMANCE TEST
IF gain uncertainty test
- DESCRIPTION

The IF step amp consists of two 10dB amps and four 20dB amps. In addition, it contains the 10dB amp that is used for the R3265A in the Low Noise mode. These amplifier gains can be adjusted using the variable resistors. If the amp has the 10dB gain, it must be adjusted so that its output level matches the original one when the CAL Signal Level is reduced for 10 dB. Also, if the amp has the 20dB gain, it must be adjusted so that the output level matches the original one when the CAL Signal Level is reduced for 20 dB.

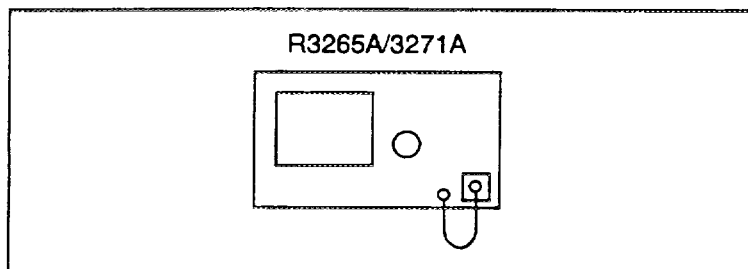

Figure 5-8 IF Step Amp Adjustment

- EQUIPMENT

Cable	MC-61; BNC (male), 10 cm long
Adapter	JUG-201A/U; type N (male) to BNC (female)
- PROCEDURE
 - (1) Turn off the POWER switch of the R3265A/3271A, unplug the power cord, and remove the system cover. Plug the power cord, turn the POWER switch on, and warm up the system 30 minutes or more.
 - (2) Connect the BNC cable (using the N-BNC conversion adapter) between the CAL OUT and INPUT terminals of the R3265A/3271A.

[Crystal Filter Adjustment]

- (1) Perform Steps (1) to (3) of the lithium tantalum filter adjustment.
- (2) Set the RBW of R3265A/3271A to 10 Hz.
- (3) Connect the probe to TP8.
- (4) Adjust C75 to have the highest display level of R3361.
- (5) Adjust C85 in the same way as for Step (4).
- (6) Repeat Steps (4) and (5) to have the highest display level of R3361.
- (7) Connect the probe to TP13.
- (8) Adjust C137 and C149 in the same way as for Steps (4) to (6).
- (9) Set the RBW of R3265A/3271A to 1 kHz.
- (10) Connect the probe to TP7.
- (11) Set the SPAN of R3361 to 2 kHz, and set its SCALE to 10 dB/div. Also, adjust C71 so that the right and left sides of waveforms have the same signal level on the screen.
- (12) Set the SPAN of R3361 to 2 kHz, and set its SCALE to 1 dB/div. Also, adjust L26 so that the peak of waveforms comes to the center of the screen.
- (13) Connect the probe to TP8, and adjust C83 in the same way as for Step (11). Also, adjust L30 in the same way as for Step (12).
- (14) Connect the probe to TP12, and adjust C135 in the same way as for Step (11). Also, adjust L44 in the same way as for Step (12).
- (15) Connect the probe to TP13, and adjust C147 in the same way as for Step (11). Also, adjust L48 in the same way as for Step (12).

- (16) Set the R3361 to 10 dB/div, and adjust C41 so that the right and left sides of waveforms have the same signal level on the screen.
- (17) Set the R3361 to 1 dB/div, and adjust L18 so that the peak of the waveforms comes to the center of the screen.
- (18) Connect the probe to TP6, and adjust C55 in the same way as for Step (16). Also, adjust L22 in the same way as for Step (17).
- (19) Connect the probe to TP10, and adjust C108 in the same way as for Step (16). Also, adjust L36 in the same way as for Step (17).
- (20) Connect the probe to TP11, and adjust C121 in the same way as for Step (16). Also, adjust L40 in the same way as for Step (17).

- (3) Press the **PRESET** key of the R3265A/3271A, hold down the **SHIFT** key and press **CAL** **7** key to set the **CAL CORR ON/OFF** to OFF.

Also, press the **PRESET** key of the R3361, and set the controls as follows:

CENTER FREQ	3.5795 MHz
SPAN	0 Hz
REF. LEVEL	-25 dBm
SCALE	1 dB/div
TG LEVEL	-10 dBm
RBW	100 Hz
10 MHz REF	EXT IN

Press the **PRESET** key of the TR4515, and set the controls as follows:

CW FREQ	25 MHz
LEVEL	+10 dBm
10 MHz REF	EXT IN

- (4) Press the **CPL** and **RBW** keys of the R3265A/3271A to set the RBW to 3 kHz.
- (5) Connect the probe from R3361 to TP6.
- (6) Adjust C43 of the IF block to have the highest display level of R3361.
- (7) Adjust C57 in the same way as for Step (6).
- (8) Repeat Steps (6) and (7) to have the highest display level of R3361.
- (9) Connect the probe to TP11.
- (10) Adjust C110 of the IF block to have the highest display level of R3361.
- (11) Adjust C123 in the same way as for Step (10).
- (12) Repeat Steps (10) and (11) to have the highest display level of R3361.
- (13) Set the SPAN of R3361 to 500 kHz, and set RBW to AUTO.
- (14) Set the RBW of R3265A/3271A to 100 kHz.
- (15) Connect the probe to TP5.

[Resonator Filter Adjustment]

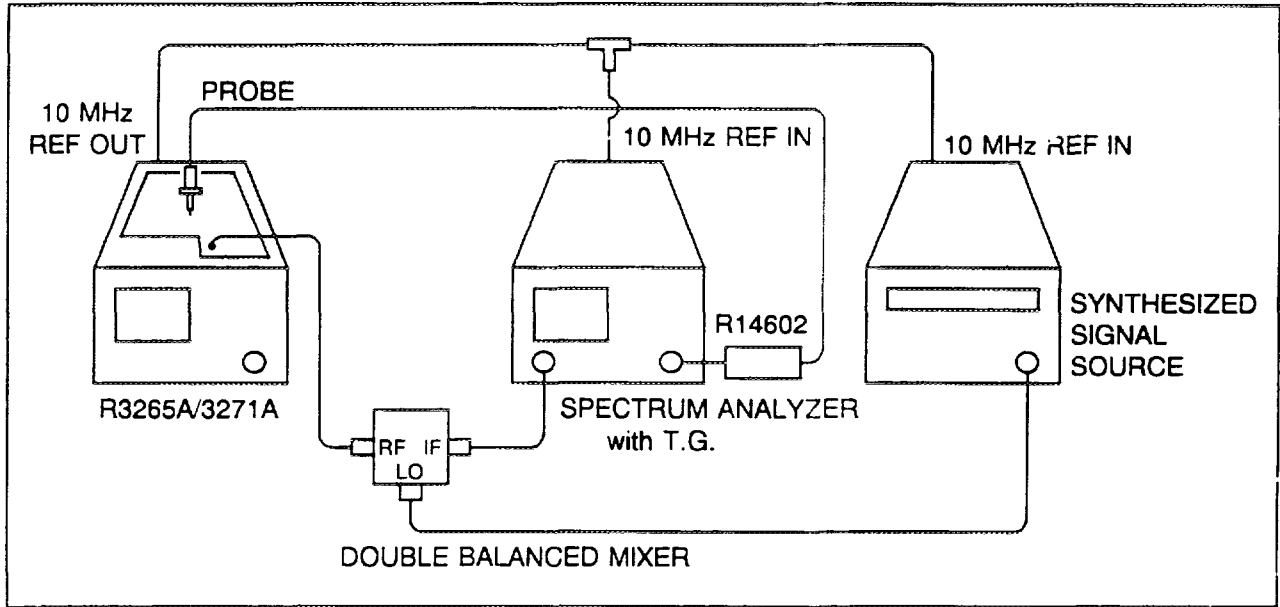

Figure 5-7 Resonator Filter Adjustment Setup

• EQUIPMENT

Spectrum analyzer with TG	R3361A/B
Synthesized signal source	TR4515
Double balanced mixer	Frequency range: 10 to 100 MHz
Probe	P6133
Cable	MI-09; BNC (male), 150 cm long
Impedance converter	R14602
Coaxial cable and others for mixer connection		

• PROCEDURE

Adjustment of lithium tantalum filter:

- (1) Turn off the POWER switch of the R3265A/3271A, unplug the power cord, and remove the system cover. Then, remove the top cover from the interface (IF) block. Plug the power cord, turn the POWER switch on, and warm up the system 30 minutes or more.
- (2) Connect the BNC cables between the 10 MHz REF IN/OUT terminal of R3265A/3271A, 10 MHz REF terminal of R3361, and the EXT 10 MHz terminal of TR4515. Also, connect the TG of R3361 to the IF port of the double balanced mixer. Connect the OUTPUT terminal of TR4515 to the LO port of the double balanced mixer. Connect the J1 terminal of IF block of the R3265A/3271A to the RF port of the double balanced mixer. Connect the probe to the INPUT terminal of R3361 using the R14602 impedance converter.

(2) Connect the UM-BNC cable (and N-BNC conversion adapter) between J1 of the IF block and TG OUTPUT of the R3361. Connect the probe to the INPUT terminal of R3361 using the R14602 impedance converter.

(3) Press the **RESET** key of the R3361 and set the controls as follows:

CENTER FREQ	21.4205 MHz
SPAN	1 MHz
REF. LEVEL	-15 dBm
SCALE	1 dB/div
TG LEVEL	10 dBm

(4) Press the **RESET** key of the R3265A/3271A, hold down the **SHIFT** key and press the **CAL** key to set the **CAL CORR ON/OFF** switch to OFF.

Then, press the **CPL** and **RBW** keys to set the RBW to 300 kHz.

(5) Connect the probe connected to the R3361 to TP16 of the IF block.

(6) Adjust L62 so that the peak of waveforms reaches the center of the screen on the R3361.

(7) Connect the probe to TP17, and adjust L64 in the same way as for Step (6).

(8) Connect the probe to TP18, and adjust L68 in the same way as for Step (6).

(9) Connect the UM-BNC cable (and N-BNC conversion adapter) between J5 of the IF block and the INPUT terminal of the R3361.

(10) Set the REF LEVEL of the R3361 to 0 dBm.

(11) Adjust L70 in the same way as for Step (6).

5.3.3 IF Filter Adjustment

- ASSEMBLY ADJUSTED
IF block (WBL-32xxIF)
- RELATED PERFORMANCE TEST
Resolution bandwidth accuracy and selectivity
- DESCRIPTION
The IF filter consists of the 4-stage band-pass filter of the LC and the 8-stage band-pass filter of the resonator (4-stage lithium tantalum and 4-stage crystal filters). The IF filter can easily be adjusted by observing the filter waveforms on the spectrum analyzer having the TG.

[LC Filter Adjustment]

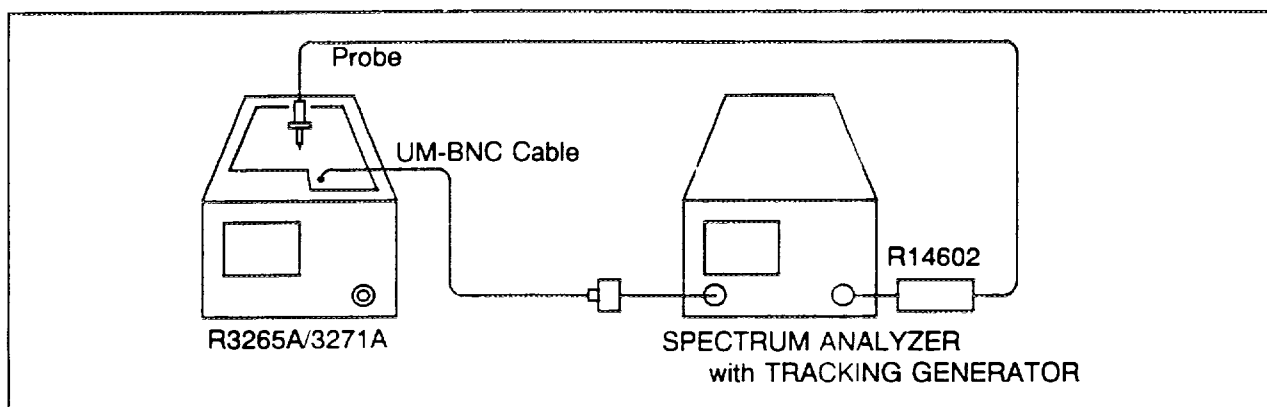

Figure 5-6 LC Filter Adjustment Setup

- EQUIPMENT

Spectrum analyzer with TG	R3361A/B
Impedance converter	R14602
Probe	P6133
Adapter:		
Type N (male) to BNC (female)	JUG-201A/U
Cable:		
UM-BNC, 100 cm long	MC-36A
- PROCEDURE

- (1) Turn off the POWER switch of the R3265A/3271A, unplug the power cord, and remove the system cover. Then, remove the top cover from the interface block (WBL-32xxIF). Plug the power cord, turn the POWER switch on, and warm up the system 30 minutes or more.

- (53) Press the **NEXT MENU** , **STEP 50 dB** keys, and adjust the data knob so that the marker value reaches the value recorded in Step (47) subtracted by $-50 \text{ dBm} \pm 0.2 \text{ dB}$.
- (54) Set the AMPLITUDE of R4262 to -60 dBm .
- (55) Press the **STEP 60 dB** key, and adjust the data knob so that the marker value reaches the value recorded in Step (47) subtracted by $-60 \text{ dBm} \pm 0.2 \text{ dB}$.
- (56) Set the AMPLITUDE of R4262 to -70 dBm .
- (57) Press the **STEP 70 dB** key, and adjust the data knob so that the marker value reaches the value recorded in Step (47) subtracted by $-70 \text{ dBm} \pm 0.2 \text{ dB}$.
- (58) Set the AMPLITUDE of R4262 to -80 dBm .
- (59) Press the **STEP 80 dB** key, and adjust the data knob so that the marker value reaches the value recorded in Step (47) subtracted by $-80 \text{ dBm} \pm 0.2 \text{ dB}$.
- (60) Press the **RETURN** , **SHIFT** , **MARKER** and **ON** keys (to write data in the EEPROM).

- (36) Set the AMPLITUDE of R4262 to -20 dBm.
- (37) Press the $\left[\begin{array}{c} \text{QP GAIN} \\ \text{ADJ} \end{array} \right]$ key, and adjust the data knob to have the marker value of -40.00 dBm ± 0.5 dB.
- (38) Set the AMPLITUDE of R4262 to -40 dBm.
- (39) Press the $\left[\begin{array}{c} \text{QP ZERO} \\ \text{ADJ} \end{array} \right]$ key, and adjust the data knob to have the marker value of -80.00 dBm ± 0.5 dB.
- (40) Repeat Steps (36) to (41) so that the $\left[\begin{array}{c} \text{QP} \\ \text{OFFSET} \end{array} \right]$, $\left[\begin{array}{c} \text{QP GAIN} \\ \text{ADJ} \end{array} \right]$ and $\left[\begin{array}{c} \text{QP ZERO} \\ \text{ADJ} \end{array} \right]$ values become 0.00 dBm ± 0.2 dB, -40.00 dBm ± 0.5 dB, and -80.00 dBm ± 0.5 dB, respectively.
- (41) Press the $\left[\text{RETURN} \right]$, $\left[\text{SHIFT} \right]$, $\left[\text{MARKER} \right]$ and $\left[\text{ON} \right]$ keys (to write data in the EEPROM)
- (42) Set the AMPLITUDE of R4262 to 0 dBm.
- (43) Press the $\left[\begin{array}{c} \text{STEP AMP} \\ \text{ADJ} \end{array} \right]$ and $\left[\text{OFF} \right]$ keys, and record the marker value.
- (44) Set the AMPLITUDE of R4262 to -10 dBm.
- (45) Press the $\left[\begin{array}{c} \text{STEP} \\ 10 \text{ dB} \end{array} \right]$ key, and adjust the data knob so that the marker value reaches the value recorded in Step (47) subtracted by -10 dBm ± 0.2 dB.
- (46) Set the AMPLITUDE of R4262 to -20 dBm.
- (47) Press the $\left[\begin{array}{c} \text{STEP} \\ 20 \text{ dB} \end{array} \right]$ key, and adjust the data knob so that the marker value reaches the value recorded in Step (47) subtracted by -20 dBm ± 0.2 dB.
- (48) Set the AMPLITUDE of R4262 to -30 dBm.
- (49) Press the $\left[\begin{array}{c} \text{STEP} \\ 30 \text{ dB} \end{array} \right]$ key, and adjust the data knob so that the marker value reaches the value recorded in Step (47) subtracted by -30 dBm ± 0.2 dB.
- (50) Set the AMPLITUDE of R4262 to -40 dBm.
- (51) Press the $\left[\begin{array}{c} \text{STEP} \\ 40 \text{ dB} \end{array} \right]$ key, and adjust the data knob so that the marker value reaches the value recorded in Step (47) subtracted by -40 dBm ± 0.2 dB.
- (52) Set the AMPLITUDE of R4262 to -50 dBm.

- (19) Press the $\boxed{\text{LIN}}_{20 \text{ dB}}$ key, and adjust the data knob to have the marker value of 0.00 dBm ± 0.2 dB.
- (20) Set the AMPLITUDE of R4262 to -30 dBm.
- (21) Press the $\boxed{\text{LIN}}_{30 \text{ dB}}$ key, and adjust the data knob to have the marker value of 0.00 dBm ± 0.2 dB.
- (22) Set the AMPLITUDE of R4262 to -40 dBm.
- (23) Press the $\boxed{\text{NEXT MENU}}$ and $\boxed{\text{LIN}}_{40 \text{ dB}}$ keys, and adjust the data knob to have the marker value of 0.00 dBm ± 0.2 dB.
- (24) Set the AMPLITUDE of R4262 to -50 dBm.
- (25) Press the $\boxed{\text{LIN}}_{50 \text{ dB}}$ key, and adjust the data knob to have the marker value of 0.00 dBm ± 0.2 dB.
- (26) Set the AMPLITUDE of R4262 to -60 dBm.
- (27) Press the $\boxed{\text{LIN}}_{60 \text{ dB}}$ key, and adjust the data knob to have the marker value of 0.00 dBm ± 0.2 dB.
- (28) Set the AMPLITUDE of R4262 to -70 dBm.
- (29) Press the $\boxed{\text{LIN}}_{70 \text{ dB}}$ key, and adjust the data knob to have the marker value of 0.00 dBm ± 0.2 dB.
- (30) Set the AMPLITUDE of R4262 to -80 dBm.
- (31) Press the $\boxed{\text{LIN}}_{80 \text{ dB}}$ key, and adjust the data knob to have the marker value of 0.00 dBm ± 1 dB.
- (32) Press the $\boxed{\text{RETURN}}$, $\boxed{\text{SHIFT}}$, $\boxed{\text{MARKER}}$ and $\boxed{\text{ON}}$ keys (to write data in the EEPROM).
- (33) Press the $\boxed{\text{QP}}$, $\boxed{\text{QP ZERO ADJ}}$, $\boxed{\text{QP GAIN ADJ}}$ and $\boxed{\text{QP OFFSET}}$ keys in this sequence.
- (34) Set the AMPLITUDE of R4262 to 0 dBm.
- (35) Adjust the data knob to have the marker value of 0.00 dBm ± 0.2 dB.

- (4) Press the **PRESET** key of the R3265A/3271A, and set the controls as follows:

CENTER FREQ	0 MHz
FREQ SPAN	10 MHz
VBW	1 kHz
MARKER	ON

- (5) Hold down the **SHIFT** key and press the **5** key on the R3265A/3271A.
 When the "Please input password!!" message appears, press the **9** , **4** , **2** , **8**
 and **4** keys in this sequence.

- (6) Hold down the **SHIFT** key and press the **REF LEVEL** key.
- (7) Press the **LOG** key.
- (8) Set the AMPLITUDE of R4262 to 0 dBm.
- (9) Press the **GAIN ADJ** and **LOG** keys, and adjust the data knob to have the marker value of 0.00 dBm \pm 0.2 dB.

- (10) Set the AMPLITUDE of R4262 to -90 dBm.
- (11) Press the **RETURN** and **LOG OFFSET** keys, and adjust the data knob to have the marker value of -90.00 dBm \pm 0.2 dB.
- (12) Repeat Steps (12) to (15) so that the **LOG** and **LOG OFFSET** values become 0.00 dBm \pm 0.2 dB and -90.00 dBm \pm 0.2 dB, respectively.
- (13) Press the **RETURN** , **GAIN ADJ** , **LIN** keys in this sequence.
- (14) Set the AMPLITUDE of R4262 to 0 dBm.
- (15) Adjust the data knob to have the marker value of 0.00 dBm \pm 0.2 dB.
- (16) Set the AMPLITUDE of R4262 to -10 dBm.
- (17) Press the **LIN 10 dB** key, and adjust the data knob to have the marker value of 0.00 dBm \pm 0.2 dB.
- (18) Set the AMPLITUDE of R4262 to -20 dBm.

(14) Press the **RETURN**, **SHIFT**, **MARKER** and **ON** keys (to write data in the EEPROM).

[LOG/LIN GAIN, OFFSET, STEP AMP, and QP Adjustment]

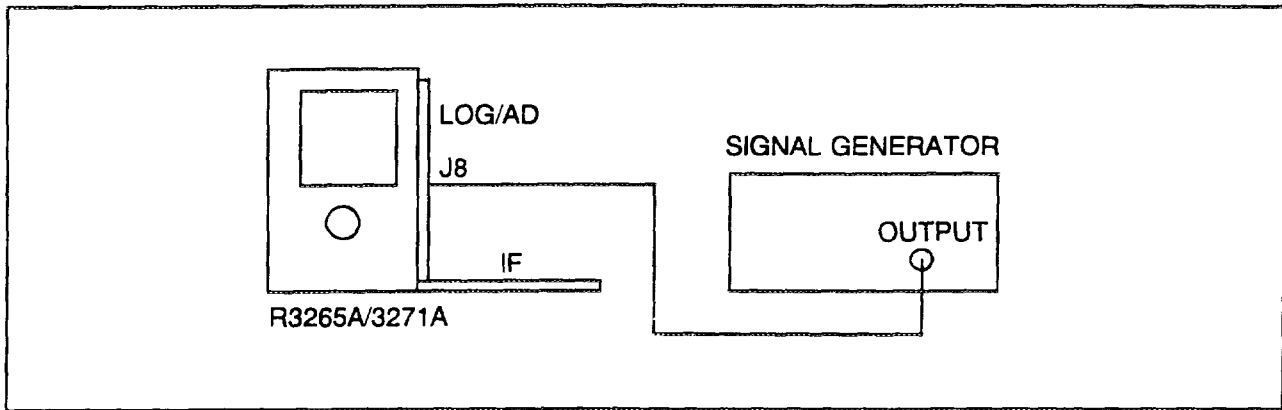

Figure 5-5 Adjustment Setup

• EQUIPMENT

- Signal generator R4262
- Cable MI-09; BCN (male), 150 cm long

• PROCEDURE

- (1) Turn off the POWER switch of the R3265A/3271A, unplug the power cord, and remove the system cover. Place the system in the side angle, remove the interface block screws, and open the interface block.
Plug the power cord, turn the POWER switch on, and warm up the system 30 minutes or more.
- (2) Connect the signal cable between J8 of the LOG block and the OUTPUT terminal of R4262.
- (3) Set the R4262 as follows:
FREQ 21.42 MHz

[MAG AMP Adjustment]

● PROCEDURE

(1) Turn on the POWER switch of the R3265A/3271A and warm up it 30 minutes or more.

(2) Press the **PRESET** key of the R3265A/3271A and set the controls as follows:

CENTER FREQ 0 MHz
 FREQ SPAN 10 kHz
 VBW 1 kHz
 MARKER ON

(3) Hold down the **SHIFT** key and press the **5** key on the R3265A/3271A.

When the "Please input password!!" message appears, press the **9**, **4**, **2**, **8** and **4** keys in this sequence.

(4) Hold down the **SHIFT** key and press the **PEF LEVEL** key.

(5) Press the **LOG** and **MAG ADJ** keys.

(6) Press the **MAG 10/5 dB.A** key, and adjust the data knob to have the marker value of $-100.00 \text{ dBm} \pm 0.2 \text{ dB}$.

(7) Press the **MAG 10/5 dB.B** key, and adjust the data knob to have the marker value of $0.00 \text{ dBm} \pm 0.2 \text{ dB}$.

(8) Press the **LIN x1, x2.A** key and enter the same value as the MAG 5dB.A data.

(9) Press the **LIN x1, x2.B** key and enter the same value as the MAG 5dB.A data.

(10) Press the **NEXT MENU** and **MAG 2 dB.A** key, and adjust the data knob to have the marker value of $-100.00 \text{ dBm} \pm 0.2 \text{ dB}$.

(11) Press the **MAG 2 dB.B** key, and adjust the data knob to have the marker value of $0.00 \text{ dBm} \pm 0.2 \text{ dB}$.

(12) Press the **MAG 1 dB.A** key, and adjust the data knob to have the marker value of $-100.00 \text{ dBm} \pm 0.2 \text{ dB}$.

(13) Press the **MAG 1 dB.B** key, and adjust the data knob to have the marker value of $0.00 \text{ dBm} \pm 0.2 \text{ dB}$.

- (3) Press the **PRESET** key of the R3265A/3271A, and set the controls as follows:
- | | | |
|-------------|-------|--------|
| CENTER FREQ | | 0 MHz |
| FREQ SPAN | | 10 MHz |
| VBW | | 1 kHz |
- (4) Press the **PRESET** and **TG** keys of R3361B, and set the controls as follows:
- | | | |
|-------------|-------|-----------|
| CENTER FREQ | | 21.42 MHz |
| FREQ SPAN | | 5 MHz |
| TG LEVEL | | -10 dBm |
| dB/DIV | | 1 dB/DIV |
- (5) Hold down the **SHIFT** key and press the **BK SP** key of the R3265A/3271A to select the Debug mode. Then, press the following keys in this sequence.
- 4 1 0 2 7 0 ENTER 0 7 ENTER**
- (6) Adjust L14 so that the peak of waveforms comes at the center of the screen on the R3361B.
- (7) Press the following keys in this sequence on the R3265A/3271A:
- 4 1 0 2 7 0 ENTER 2 7 ENTER**
- (8) Press the **B** **WRITE** **B**, and **VIEW** **B** keys on the R3361 to store the waveforms.
- (9) Press the following keys in this sequence on the R3265A/3271A:
- 4 1 0 2 7 0 ENTER 0 7 ENTER**
- (10) Adjust R239 so that the peak of the waveforms on the R3361B reaches the same level as that stored in **B** .
- (11) Repeat Steps (7) to (10) so that they have the same level.

5.3.2 Log Amp Adjustment

- ASSEMBLY ADJUSTMENT

Log block (WBL-32xxLOG)

- RELATED PERFORMANCE TEST

Scale fidelity

- DESCRIPTION

The Log Amp can be adjusted for 21.4 MHz BPF by changing the coil and variable resistor values. The LOG/LIN GAIN, OFFSET, MAG AMP, STEP AMP, and QP DET values can be adjusted by changing the DAC data.

[21.4 MHz BPF Adjustment]

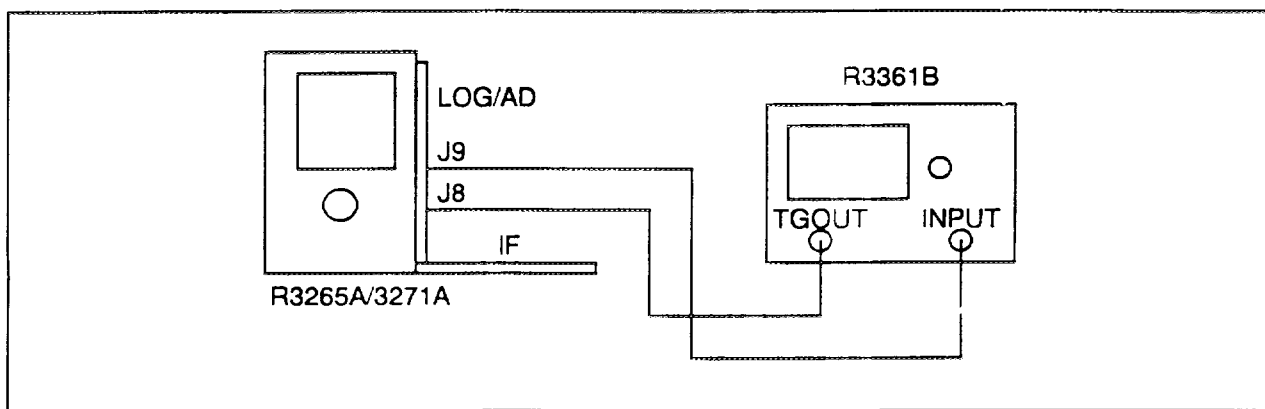

Figure 5-4 21.4 MHz B.P.F. Adjustment Setup

- EQUIPMENT

Spectrum analyzer with TG	R3361B
Cable	MI-09; BNC (male), 150 cm long

- PROCEDURE

- (1) Turn off the POWER switch of the R3265A/3271A, unplug the power cord, and remove the system cover. Place the system in the side angle, remove the interface block screws, and open the interface block.

Plug the power cord, turn the POWER switch on, and warm up the system 30 minutes or more.

- (2) Connect the signal cable between J8 of the LOG block and the TG OUT terminal of R3361. Also, connect the cable between J9 of the LOG block and the INPUT terminal of R3361.

(6) Set the HP3325A as follows:

FREQ	50 Hz (SINE)
AMPTD	900 mV
DC OFFSET	500 mV

(7) Adjust R111 so that the smooth waveforms are displayed on the screen.

[Slope Detector Adjustment]

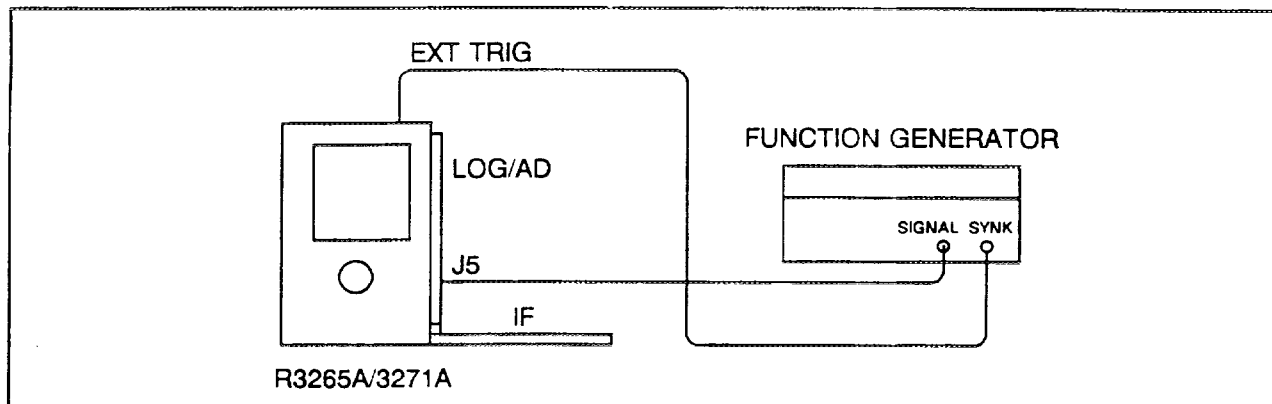

Figure 5-3 Setup for Slope Detector Adjustment

• EQUIPMENT

- Function generator HP3325A
- Cable MI-09; BNC (male), 150 cm long

(1) Turn off the POWER switch of the R3265A/3271A, unplug the power cord, and remove the system cover. Place the system in the side angle, remove the interface block screws, and open the interface block.

Plug the power cord, turn the POWER switch on, and warm up the system 30 minutes or more.

(2) Connect the BNC cable between the EXT TRIG terminal and SYNC OUT terminal of the HP3325A on the R3265A/3271A rear panel.

(3) Connect the signal cable between J5 of the AD block and SIGNAL terminal of HP3325A.

(4) Press the **PRESET** key of the R3265A/3271A, and set the controls as follows:

FREQ SPAN ZERO SPAN
 TRIG EXT

(5) Hold down the **SHIFT** key and press the **BK SP** key of the R3265A/3271A to select the Debug mode. Then, press the following keys in this sequence.

3 1 5 0 0 0 **ENTER** **1 2** **ENTER**

Press the **RETURN** key to exit the Debug mode.

- (18) Press the $\begin{bmatrix} \text{P-P/D} \\ \text{TOP} \end{bmatrix}$ key, and adjust R16 so that the marker value variation comes within ± 0.03 dB.
- (19) Press the $\begin{bmatrix} \text{RETURN} \end{bmatrix}$ and $\begin{bmatrix} \text{N-P/D} \end{bmatrix}$ keys. (Negative peak detector)
- (20) Press the $\begin{bmatrix} \text{BOTTOM} \end{bmatrix}$ key, and adjust the data knob to have the marker value of -100 ± 0.03 dB.
- (21) Press the $\begin{bmatrix} \text{TOP} \end{bmatrix}$ key, and adjust R42 to have the marker value of 0.00 ± 0.03 dB.
- (22) Repeat Steps (20) and (21) until the $\begin{bmatrix} \text{BOTTOM} \end{bmatrix}$ and $\begin{bmatrix} \text{TOP} \end{bmatrix}$ -100 ± 0.03 dB and 0.00 ± 0.03 dB, respectively.
- (23) Press the $\begin{bmatrix} \text{RETURN} \end{bmatrix}$ and $\begin{bmatrix} \text{FFT} \end{bmatrix}$ keys (to select the FFT mode).
- (24) Press the $\begin{bmatrix} 0 \text{ dB} \\ \text{BOTTOM} \end{bmatrix}$ key, and adjust the data knob to have the marker value of -31.25 ± 0.03 dB.
- (25) Press the $\begin{bmatrix} 0 \text{ dB} \\ \text{TOP} \end{bmatrix}$ key, and adjust R67 to have the marker value of -68.75 ± 0.03 dB.
- (26) Repeat Steps (24) and (25) until the $\begin{bmatrix} 0 \text{ dB} \\ \text{BOTTOM} \end{bmatrix}$ and $\begin{bmatrix} 0 \text{ dB} \\ \text{TOP} \end{bmatrix}$ values reach -31.25 ± 0.03 dB and -68.75 ± 0.03 dB, respectively.
- (27) Press the $\begin{bmatrix} 20 \text{ dB} \\ \text{BOTTOM} \end{bmatrix}$ key, and adjust the data knob so that the on-screen messages have the highest brightness.
- (28) Press the $\begin{bmatrix} \text{RETURN} \end{bmatrix}$ and $\begin{bmatrix} \text{HIGH A/D} \end{bmatrix}$ keys (to select the high-speed mode).
- (29) Press the $\begin{bmatrix} \text{BOTTOM} \end{bmatrix}$ key, and adjust the data knob to have the marker value of -100 ± 0.00 dB.
- (30) Press the $\begin{bmatrix} \text{TOP} \end{bmatrix}$ key, and adjust the data knob to have the marker value of 0.00 ± 0.00 dB.
- (31) Repeat Steps (29) and (30) until the $\begin{bmatrix} \text{BOTTOM} \end{bmatrix}$ and $\begin{bmatrix} \text{TOP} \end{bmatrix}$ values reach -100 ± 0.00 dB and 0.00 ± 0.00 dB, respectively.
- (32) Press the $\begin{bmatrix} \text{RETURN} \end{bmatrix}$, $\begin{bmatrix} \text{SHIFT} \end{bmatrix}$, $\begin{bmatrix} \text{MARKER} \end{bmatrix}$ and $\begin{bmatrix} \text{ON} \end{bmatrix}$ keys (to write data in the EEPROM).

- (3) Hold down the **SHIFT** key and press the **5** key on the R3265A/3271A.
When the "Please input password!!" message appears, press **9**, **4**, **2**, **8** and **4** keys in this sequence.
- (4) Hold down the **SHIFT** key and press the **REF LEVEL** key.
- (5) Press the **A/D** and **X3.52 AMP** keys (to select the Sample mode).
- (6) Press the **BOTTOM** key and adjust the data knob to have the marker value of -100.00 ± 0.03 dB.
- (7) Press the **TOP** key and adjust R84 to have the marker value of 0.00 ± 0.03 dB.
- (8) Repeat Steps (6) and (7) until the **BOTTOM** and **TOP** values reach -100 ± 0.03 dB and 0.00 ± 0.03 dB, respectively.
- (9) Press the **RETURN** and **POSI-NEGA** keys (to select the Positive-Negative mode).
- (10) Press the **P-N1 BOTTOM** key, and adjust the data knob to have the marker value of -100 ± 0.03 dB.
- (11) Press the **P-N1 TOP** key, and adjust R11 to have the marker value of 0.00 ± 0.03 dB.
- (12) Repeat Steps (10) and (11) until the **P-N1 BOTTOM** and **P-N1 TOP** values reach -100 ± 0.03 dB and 0.00 ± 0.03 dB, respectively.
- (13) Press the **P-N2 BOTTOM** key, and adjust the data knob to have the marker value of -100 ± 0.03 dB.
- (14) Press the **RETURN** and **P-P/D** keys. (Positive peak detector)
- (15) Press the **P-P/D1 BOTTOM** key, and adjust the data knob to have the marker value of -100 ± 0.03 dB.
- (16) Press the **P-P/D2 BOTTOM** key, and adjust the data knob to have the marker value of -100 ± 0.03 dB.
- (17) As the **P-P/D1 BOTTOM** and **P-P/D2 BOTTOM** data are displayed alternately, repeat Steps (15) and (16) until the two lines become a single line.

● PROCEDURE

- (1) Turn off the POWER switch of the R3265A/3271A, unplug the power cord, and remove the system cover. Place the system in the side angle, remove the interface block screws, and open the interface block. Also, remove the top cover (MBS-72887) from the A/D section.

Plug the power cord, and turn the POWER switch on.

- (2) Connect the DVM probe between TP1 (GND) and TP3 (REF), and adjust R157 to have $+2.000 \pm 1$ mV.

[Adjusting the positive peak detector, negative peak detector, sample mode, FFT mode, and high-speed mode]

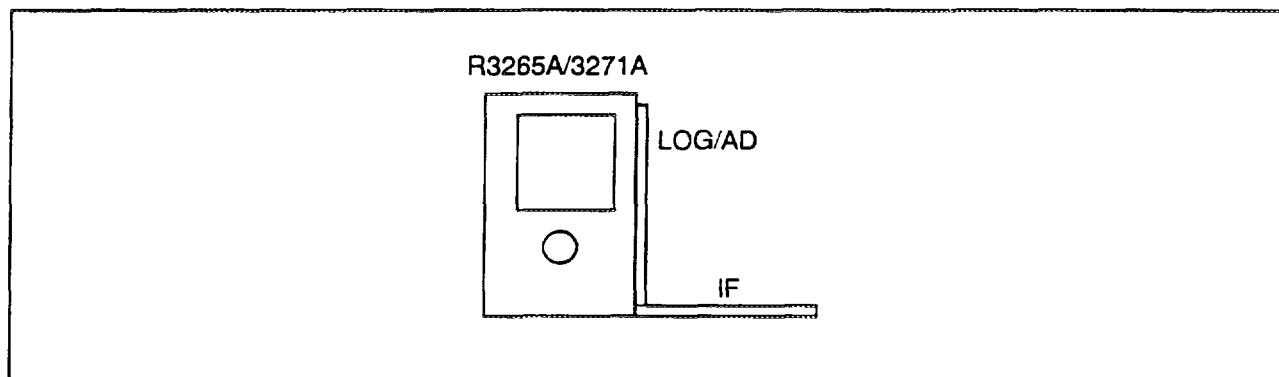

Figure 5-2 Adjustment Setup

● PROCEDURE

- (1) Turn off the POWER switch of the R3265A/3271A, unplug the power cord, and remove the system cover. Place the system in the side angle, remove the interface block screws, and open the interface block. Also, remove the top cover (MBS-72887) from the A/D section.

Plug the power cord, turn the POWER switch on, and warm up the system 30 minutes or more.

- (2) Press the PRESET key of the R3265A/3271A, and press the MARKER ON key.

5.3 Adjustment

5.3.1 A/D Adjustment

- - ASSEMBLY ADJUSTMENT
 Log block (WBL-32xxLOG)
- - RELATED PERFORMANCE TEST
 There is no related performance test.
- - DESCRIPTION

The A/D adjustment including offset and gain adjustment of the positive peak detector, negative peak detector, sample mode, FFT mode, and high-speed mode can be made by changing the DAC data and variable resistance. Also, the reference voltage and slope detector can be adjusted by changing the variable resistance.

[Reference Voltage Adjustment]

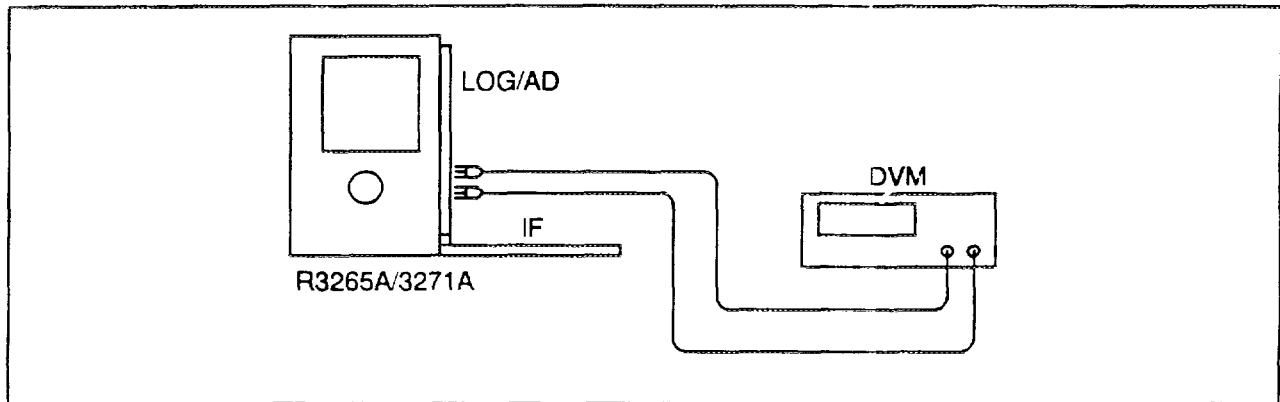

Figure 5-1 Setup for Reference Voltage Adjustment

- - EQUIPMENT

DVM	TR6851
Probe	P6133

5.2 Preliminary Operations

WARNING

Always make sure that the power cord of the spectrum analyzer is plugged into a three-hole grounded outlet or two-hole outlet with the grounded adapter. You can be fatally shocked if you fail to follow this rule.

Do not touch live circuits when adjusting an instrument.

- (1) Always confirm that the POWER switch is OFF before connecting the power cord to the AC line.
- (2) Before performing any adjustment, allow the instrument to warm up for five minutes.

5.1. Measurement Standards and Support Test Equipment Performance Requirements

Table 5-2 Support Measuring & Test Equipment (M&TE) Performance Requirements

Equipment Generic Name (Quantity)	Minimum Use Specifications (MUS)	Manufacturer /Model/Option Applicable
Adapter	Type N (male) to BNC (female)	JUG -201A/U (Hirose)
Adapter	Type N (male) to SMA (female)	HRM-554S
Adapter	SMA (male) to SMA (male)	50-673-0000-31 (Selectro)
Adapter	Type N (female) to BNC (male)	NJ-BNCP (DDK)
Adapter	SMA (female) to SMA (female)	HRM-501 (Hirose)
20 dB fixed attenuator	Connector: SMA (male), SMA (female)	AT-120 (Hirose)
Low-pass filter	Cutoff frequency: 2.2 GHz Rejection at 3 GHz: > 40 dB Rejection at 3.8 GHz: > 80 dB	DEE-001172-1 (Advantest)
Double balanced mixer	Frequency range: 10 to 100 MHz	
Cable	Frequency range: DC to 26.5 GHz Maximum SWR: < 1.45 at 26.5 GHz Length: Approx. 70 cm Connector: SMA (male) at both ends	A01002
Cable	Length: 150 cm Connection: BNC (male) at both ends	MI-09
Cable	Length: 10 cm Connection: BNC (male) at both ends	MC-61
Cable	Frequency: 21.4 MHz Length: 100 cm Connector: UM (male), BNC (male)	MC-36A
Probe	Frequency: 21.4 MHz 10:1 Impedance: 10 MHz	P6133 (Tektronix)

Table 5-1 Measurement Standards (MS) Performance Requirements (2 of 2)

Equipment Generic Name (Quantity)	Minimum Use Specifications (MUS)	Manufacturer /Model/Option Applicable
Digital multimeter	DC voltage resolution: 5 digits or more	TR6851
Spectrum analyzer	Frequency range: Up to 4.5 GHz	TR4173
Synthesized signal generator	Frequency range: 10 MHz to 4 GHz Residual SSB phase noise: 1 kHz offset < -115 dBc/Hz 10 kHz offset < -125 dBc/Hz 100 kHz offset < -130 dBc/Hz Power level range: -100 to +10 dBm	R4262
Power meter	Accuracy : ± 0.02 dB Decibel relative mode	HP436A
Power sensor	Frequency range: 50 MHz to 26.5 GHz Power range: 1 μ W to 100 mW Maximum SWR: 1.25 (26.5 GHz)	HP8485A
Power sensor	Frequency range: 10 MHz to 18 GHz Power range: 1 μ W to 100 mW	HP8481A
Spectrum analyzer	Frequency range: Up to 100 MHz With built-in TG	R3361B
Sweeper	Frequency range: 10 MHz to 26.5 GHz Power range: -5 to +10 dBm (at 3.0 GHz)	HP8350 and HP83595A
Sweep adapter		TR13211
Frequency comparator	Frequency: 10 MHz 1×10^{-9} frequency detectable	
Impedance generator		R14602

5.1. Measurement Standards and Support Test Equipment Performance Requirements

5. ADJUSTMENT

5.1 Measurement Standards and Support Test Equipment Performance Requirements

The Minimum Use Specifications (MUS) are the calculated minimum performance specifications criteria needed for the Measurement Standards (MS) and support M&TE to be used for comparison measurement required in the Adjustment Procedure (AP) process.

The MUS is developed through uncertainty analysis and is calculated through assignment of a defined and documented uncertainty/accuracy ratio or margin between the specified tolerances of the UUT and the capability (uncertainty specifications) required of the measurement standards system. The MUS is required to assist a measurement specialist in the evaluation of existing or selected alternate measurement standards equipment.

MS and SM&TE environmental range: Temperature: 18 to 28°C
Relative humidity: 30 to 70%

MS and SM&TE warmup/stabilization period requirements: 60 minutes

Table 5-1 Measurement Standards (MS) Performance Requirements (1 of 2)

Equipment Generic Name (Quantity)	Minimum Use Specifications (MUS)	Manufacturer/Model /Option Applicable
Frequency standard	Output frequency: 10 MHz Stability: 5×10^{-10} /day Output impedance: Approx. 50 Ω Output voltage: 1 Vp-p or more	TR3110
Synthesized sweeper	Frequency range: 10 to 18 MHz Frequency accuracy (CW): 3×10^{-8} /day Power level range: -15 to +15 dBm	TR4515
Frequency synthesizer	Frequency range: 1 to 20 MHz Stability: 5×10^{-6} /year Power level range: -10 to +13 dBm	HP 3325

Table 4-32 Performance Test Record (12 of 12)

Para. No.	Test Description	Results		
		Min.	Actual	Max.
18	Input Attenuator Accuracy (cont'd)			
	< R3271A ONLY >			
	Step-to-Step Accuracy			
	20 dB	-1.8 dB		+1.8 dB
	30 dB	-1.8 dB		+1.8 dB
	40 dB	-1.8 dB		+1.8 dB
	50 dB	-1.8 dB		+1.8 dB
	60 dB	-1.8 dB		+1.8 dB
	70 dB	-1.8 dB		+1.8 dB
19	Sweep Time Accuracy			
	50 μ s	44.1 μ s		46.8 μ s
	100 μ s	88.2 μ s		93.6 μ s
	200 μ s	177 μ s		187 μ s
	500 μ s	441 μ s		468 μ s
	1 ms	882 μ s		936 μ s
	2 ms	1.77 ms		1.87 ms
	5 ms	4.41 ms		4.68 ms
	10 ms	8.82 ms		9.36 ms
	20 ms	17.7 ms		18.7 ms
	50 ms	44.1 ms		46.8 ms
	100 ms	88.2 ms		93.6 ms
	200 ms	177 ms		187 ms
	500 ms	441 ms		468 ms
	1 s	882 ms		936 ms
	2 s	1.77 s		1.87 ms
	5 s	4.41 s		4.68 ms
	10 s	8.82 s		9.36 ms
	20 s	17.7 s		18.7 ms
	50 s	44.1 s		46.8 ms
	100 s	88.2 s		93.6 s
20	Calibration Amplitude Accuracy			
		-10.3 dBm		-9.7 dBm

Table 4-32 Performance Test Record (11 of 12)

Para. No.	Test Description	Results		
		Min.	Actual	Max.
18	Input Attenuator Accuracy (4 GHz Center Freq)			
	Switching Accuracy			
	20 dB	-2 dB		+2 dB
	30 dB	-2 dB		+2 dB
	40 dB	-2 dB		+2 dB
	50 dB	-2 dB		+2 dB
	60 dB	-2 dB		+2 dB
	70 dB	-2 dB		+2 dB
	Step-to-Step Accuracy			
	20 dB	-1.1 dB		+1.1 dB
	30 dB	-1.1 dB		+1.1 dB
	40 dB	-1.1 dB		+1.1 dB
	50 dB	-1.1 dB		+1.1 dB
	60 dB	-1.1 dB		+1.1 dB
	70 dB	-1.1 dB		+1.1 dB
	< R3271A ONLY >			
	(15 GHz Center Freq)			
	Switching Accuracy			
	20 dB	-2.5 dB		+2.5 dB
	30 dB	-2.5 dB		+2.5 dB
	40 dB	-2.5 dB		+2.5 dB
	50 dB	-2.5 dB		+2.5 dB
	60 dB	-2.5 dB		+2.5 dB
	70 dB	-2.5 dB		+2.5 dB
	Step-to-Step Accuracy			
	20 dB	-1.3 dB		+1.3 dB
	30 dB	-1.3 dB		+1.3 dB
	40 dB	-1.3 dB		+1.3 dB
	50 dB	-1.3 dB		+1.3 dB
	60 dB	-1.3 dB		+1.3 dB
70 dB	-1.3 dB		+1.3 dB	
(18 GHz Center Freq)				
Switching Accuracy				
20 dB	-3.5 dB		+3.5 dB	
30 dB	-3.5 dB		+3.5 dB	
40 dB	-3.5 dB		+3.5 dB	
50 dB	-3.5 dB		+3.5 dB	
60 dB	-3.5 dB		+3.5 dB	
70 dB	-3.5 dB		+3.5 dB	

Table 4-32 Performance Test Record (10 of 12)

Para. No.	Test Description	Results		
		Min.	Actual	Max.
17	Scale Fidelity			
	1 dB/div Log Scale Fidelity			
	-1 dB	-0.2 dB		+0.2 dB
	-2 dB	-0.2 dB		+0.2 dB
	-3 dB	-0.2 dB		+0.2 dB
	-4 dB	-0.2 dB		+0.2 dB
	-5 dB	-0.2 dB		+0.2 dB
	-6 dB	-0.2 dB		+0.2 dB
	-7 dB	-0.2 dB		+0.2 dB
	-8 dB	-0.2 dB		+0.2 dB
	-9 dB	-0.2 dB		+0.2 dB
	-10 dB	-0.2 dB		+0.2 dB
	10 dB/div Log Scale Fidelity			
	-10 dB	-1 dB		+1 dB
	-20 dB	-1 dB		+1 dB
	-30 dB	-1 dB		+1 dB
	-40 dB	-1 dB		+1 dB
	-50 dB	-1 dB		+1 dB
	-60 dB	-1 dB		+1 dB
	-70 dB	-1 dB		+1 dB
	-80 dB	-1 dB		+1 dB
	-90 dB	-1 dB		+1 dB
	Linear Scale Fidelity			
	div from Ref Level			
	1	191.2 mV		211.3 mV
	2	169.9 mV		187.8 mV
	3	148.7 mV		164.3 mV
	4	127.5 mV		140.8 mV
	5	106.2 mV		117.3 mV
	6	85.0 mV		93.9 mV
	7	63.8 mV		70.4 mV
	8	42.5 mV		46.9 mV
	9	21.3 mV		23.4 mV
QP-mode Log Scale Fidelity				
dB from Ref Level				
-10 dB	-11 dBm		-9 dBm	
-20 dB	-21 dBm		-19 dBm	
-30 dB	-31 dBm		-29 dBm	
-40 dB	-41 dBm		-39 dBm	

Table 4-32 Performance Test Record (9 of 12)

Para. No.	Test Description	Results			
		Min.	Actual	Max.	
16	IF Gain Uncertainty (cont'd)				
	RBW 3 kHz Attenuation				
	1 dB	-0.5 dB		+0.5 dB	
	2 dB	-0.5 dB		+0.5 dB	
	3 dB	-0.5 dB		+0.5 dB	
	4 dB	-0.5 dB		+0.5 dB	
	5 dB	-0.5 dB		+0.5 dB	
	6 dB	-0.5 dB		+0.5 dB	
	7 dB	-0.5 dB		+0.5 dB	
	8 dB	-0.5 dB		+0.5 dB	
	9 dB	-0.5 dB		+0.5 dB	
	10 dB	-0.5 dB		+0.5 dB	
	20 dB	-0.5 dB		+0.5 dB	
	30 dB	-0.5 dB		+0.5 dB	
	40 dB	-0.5 dB		+0.5 dB	
	50 dB	-0.7 dB		+0.7 dB	
	60 dB	-0.7 dB		+0.7 dB	
	70 dB	-0.7 dB		+0.7 dB	
		RBW 300 kHz Attenuation			
		1 dB	-0.5 dB		+0.5 dB
		2 dB	-0.5 dB		+0.5 dB
		3 dB	-0.5 dB		+0.5 dB
		4 dB	-0.5 dB		+0.5 dB
		5 dB	-0.5 dB		+0.5 dB
		6 dB	-0.5 dB		+0.5 dB
		7 dB	-0.5 dB		+0.5 dB
		8 dB	-0.5 dB		+0.5 dB
		9 dB	-0.5 dB		+0.5 dB
		10 dB	-0.5 dB		+0.5 dB
		20 dB	-0.5 dB		+0.5 dB
	30 dB	-0.5 dB		+0.5 dB	
	40 dB	-0.5 dB		+0.5 dB	
	50 dB	-0.7 dB		+0.7 dB	
	60 dB	-0.7 dB		+0.7 dB	

Table 4-32 Performance Test Record (8 of 12)

Para. No.	Test Description	Results		
		Min.	Actual	Max.
15	Frequency Response			
	< R3265A ONLY >			
	100 MHz to 3.6 GHz	-1.5 dB		+1.5 dB
	50 MHz to 2.6 GHz	-1.0 dB		+1.0 dB
	3.5 GHz to 7.5 GHz	-1.5 dB		+1.5 dB
	7.4 GHz to 8 GHz	-1.5 dB		+1.5 dB
	< R3271A ONLY >			
	100 MHz to 3.6 GHz	-1.5 dB		+1.5 dB
	50 MHz to 2.6 GHz	-1.0 dB		+1.0 dB
	3.5 GHz to 7.5 GHz	-1.5 dB		+1.5 dB
7.4 GHz to 15.4 GHz	-3.5 dB		+3.5 dB	
15.4 GHz to 23.3 GHz	-4.0 dB		+4.0 dB	
23.0 GHz to 26.5 GHz	-4.0 dB		+4.0 dB	
16	IF Gain Uncertainty			
	RBW 1 MHz Attenuation			
	1 dB	-0.5 dB		+0.5 dB
	2 dB	-0.5 dB		+0.5 dB
	3 dB	-0.5 dB		+0.5 dB
	4 dB	-0.5 dB		+0.5 dB
	5 dB	-0.5 dB		+0.5 dB
	6 dB	-0.5 dB		+0.5 dB
	7 dB	-0.5 dB		+0.5 dB
	8 dB	-0.5 dB		+0.5 dB
	9 dB	-0.5 dB		+0.5 dB
	10 dB	-0.5 dB		+0.5 dB
	20 dB	-0.5 dB		+0.5 dB
	30 dB	-0.5 dB		+0.5 dB
	40 dB	-0.5 dB		+0.5 dB
50 dB	-0.7 dB		+0.7 dB	
60 dB	-0.7 dB		+0.7 dB	

Table 4-32 Performance Test Record (7 of 12)

Para. No.	Test Description	Results		
		Min.	Actual	Max.
10	Gain Compression < R3265A ONLY > 10.5 MHz 200.5 MHz 3600.5 MHz < R3271A ONLY > 10.5 MHz 200.5 MHz 3600.5 MHz	- 10 dBm - 5 dBm - 5 dBm - 5 dBm - 5 dBm - 5 dBm		
11	Residual Response 1 MHz to 3.6 GHz 3.5 GHz to 7.5 GHz			- 100 dBm - 90 dBm
12	Second Harmonic Distortion INPUT FREQ: 1.5 GHz INPUT FREQ: 1.9 GHz			- 70 dBc - 100 dBc
13	Third Order Intermodulation Distortion < R3265A ONLY > 10.5 MHz 205 MHz 3600 MHz < R3271A ONLY > 10.5 MHz 3600 MHz			(Mixer Input Level) : -20dBm - 40 dBc - 50 dBc - 55 dBc - 50 dBc - 55 dBc
14	Image, Multiple, and Out-of-Band Response Maximum Response Amplitude < R3265A ONLY > 10 MHz to 8 GHz < R3271A ONLY > 10 MHz to 18 GHz 10 MHz to 23 GHz 10 MHz to 26.5 GHz			- 70 dBc - 70 dBc - 60 dBc - 50 dBc

(16) Adjust R114 in the same way as for Step (7).

(17) Press the following keys in this sequence.

4 2 0 0 2 0 ENTER 3 7 ENTER

(18) Adjust R120 in the same way as for Step (7).

(19) Press the following keys in this sequence.

4 2 0 0 2 0 ENTER 2 F ENTER

(20) Adjust R128 in the same way as for Step (7).

(21) Press the following keys in this sequence.

4 2 0 0 2 0 ENTER 1 F ENTER

(22) Adjust R134 in the same way as for Step (7).

(23) Press the following keys in this sequence.

4 2 0 0 2 0 ENTER 3 F ENTER RETURN

5.3.5 28.6 MHz Rejection Circuit Adjustment

- ASSEMBLY ADJUSTMENT

IF block (WBL-32xxIF)

- RELATED PERFORMANCE TEST

There is no related performance test.

- DESCRIPTION

When the interface (IF) frequency of the IF block is converted from 21.4205 MHz to 3.5795 MHz, a +7.159 MHz spurious is generated. The 28.5795 MHz frequency rejection circuit is provided to suppress the spurious generation. The circuit must be adjusted so that the 32.159 MHz spurious is reduced to -100 dBc when the 25 MHz CAL signals are entered in the INPUT terminal of R3265A/3271A.

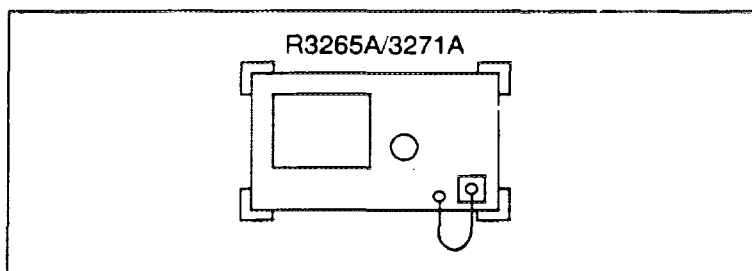

Figure 5-9 28.6 MHz Rejection Circuit Adjustment

- EQUIPMENT

Cable	MC-61; BNC (male), 10 cm long
Adapter	JUG-201A/U; type N (male) to BNC (female)

- PROCEDURE

- (1) Turn off the POWER switch of the R3265A/3271A, unplug the power cord, and remove the system cover. Plug the power cord, turn the POWER switch on, and warm up the system 30 minutes or more.

(2) Connect the BNC cable (using the N-BNC conversion adapter) between the CAL OUT and INPUT terminals of the R3265A/3271A.

(3) Press the **RESET** key of the R3265A/3271A, and set the controls as follows:

CENTER FREQ	25 MHz
SPAN	500 Hz
REF. LEVEL	0 dBm
RBW	30 kHz
DIGITAL IF	OFF

(4) Press the **RESE**, **MKR→** and **MKR→REF** keys in this sequence on the R3265A/3271A.

(5) Set the **CENTER FREQ** of the R3265A/3271A to 32.159 MHz.

Then, reduce the **PEF LEVEL** 50 dB below the current setup.

(6) Press the **CPL** and **ATT** keys of R3265A/3271A to set the Input Attenuator to 0 dB.

(7) Adjust C5 to have the minimum signal level on the screen.

(8) Adjust C6 in the same way as for Step (7).

(9) Adjust C400 in the same way as for Step (7).

(10) Repeat Steps (7) to (9) until the signal level drops below the center scale position of the screen.

Press the **MENU**, **SWEEP MODE**, and **SINGLE SWP** keys on the R3265A/3271A, and set the sweep time to 20 seconds.

Press the **MENU**, **SWEEP MODE**, and **SINGLE SWP** keys on the R3265A/3271A, and measure the frequency characteristics of sweeper output on the power meter. Using the result data, adjust the POWER LEVEL and SLOPE controls of the sweeper so that the frequency characteristics waveforms enter within $-4 \text{ dBm} \pm 1 \text{ dB}$.

Press the **MENU**, **SWEEP MODE**, and **SINGLE SWP** keys on the R3265A/3271A, and repeat Step () until the frequency characteristics waveforms enter within $-4 \text{ dBm} \pm 1 \text{ dB}$.

Press the **SAVE n** and **1** keys on the sweeper.

Disconnect the SMA cable from the power sensor, and connect it to the R3265A/3271A output.

Press the **MENU**, **SWEEP MODE**, and **CONT SWP** keys on the R3265A/3271A, and set the controls as follows:

SWEEP TIME:	500 msec
START:	3.61 GHz
TOP:	7.5 GHz

Adjust and adjust the CAL FACTOR control of the power meter to the 6GHz calibration factor of power sensor.

Repeat Steps (6) to (12).

Press the **SAVE n** and **2** keys of the sweeper.

Disconnect the SMA cable from the power sensor, and connect it to the R3265A/3271A output.

Repeat Steps (19) to (22) for the R3271A. Jump to Step (23).

The YTO offset can be made by



70 cm long

5:

- (3) Press the **RESET** key on the R3265A/3271A and set the controls as follows:

CENTER FREQ 0 Hz
SPAN 100 MHz

- (4) Hold down the **SHIFT** key and press the **5** key on the R3265A/3271A.
When the "Please input password!!" message appears, press keys **9**, **4**, **2**, **8**
and **4** in this sequence.

- (5) Press the **YTO TUNE** and **PLL ON/OFF** keys.

- (6) Press the **0 MHz ADJ** key and adjust the data knob so that the local-feed-through locates within the center scale position ± 0.5 div.

- (7) Press the **CENTER**, **3**, **.**, **5** and **GHz** keys in this sequence.

- (8) Press the **3.5 MHz ADJ** key and adjust the data knob so that the signal locates within the center scale position ± 0.5 div.

- (9) Press the **SPAN**, **1**, **0** and **MHz** keys in this sequence.

- (10) Press the **3.5 MHz ADJ** key and adjust the data knob so that the signal locates within the center scale position ± 0.5 div.

- (11) Press the **CENTER**, **0** and **MHz** keys in this sequence.

- (12) Press the **0 MHz ADJ** key and adjust the data knob so that the local-feed-through locates within the center scale position ± 0.5 div.

- (13) Repeat Steps (10) to (12) so that the 0 MHz and 3.5GHz signals locate within the center scale position ± 1 div.

[Data Writing in EEPROM]

- (14) Hold down the **SHIFT** key and press the **MARKER ON** key on the R3265A/3271A, and wait for approximately 10 seconds. Data writing in the EEPROM will complete.

- (15) Press the **PLL ON/OFF**, **RETURN** and **RETURN** keys in this sequence.

5.3.7 YTF Adjustment

- ASSEMBLY ADJUSTMENT
RF I/O assembly (BLL-017508x01/x02)
- RELATED PERFORMANCE TEST
Image, multiple and out-of-band response
Second harmonic distortion
Frequency response

- DESCRIPTION

The gain and offset of YTF tuning voltage are set by DACs on the RF I/O assembly. The offset DAC value is optimized at a low frequency and the gain DAC value is optimized at a high frequency of each band.

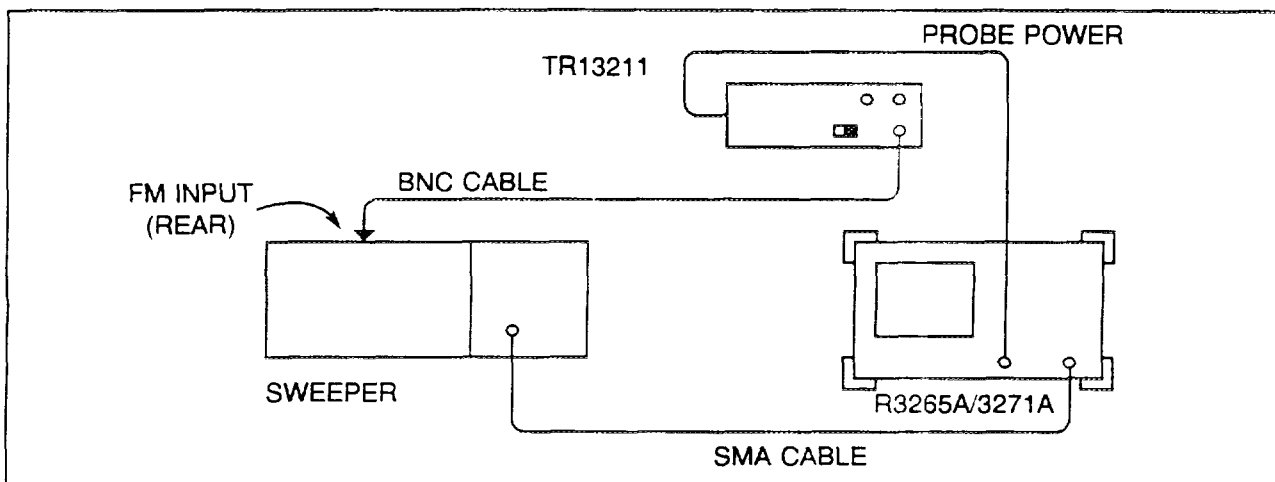

Figure 5-11 YTF Adjustment Setup

- EQUIPMENT

Sweeper:	HP8350 and HP83595A
Sweep adapter:	TR13211
Cable:	A01002; SMA (male), 70 cm long
	MI-09; BNC (male), 150 cm long

- PROCEDURE

(1) Connect the equipment as illustrated in Figure 5-11.

(2) Press the **PRESET** key on the HP8350 and set the controls as follows:

CW 3.7 GHz
Power Level -2 dBm

(3) Set the TR13211 controls as follows:

FM FREQ 200 Hz
LEVEL Approx. 10 Vpp
FM SWITCH: EXT

(4) Press the **PRESET** key on the R3265A/3271A and set the controls as follows:

CENTER FREQ 3.7 HGz
RBW: 300 kHz
dB/div: 2 dB/div
SWEEP TIME: 500 msec
SPAN: 0 Hz

(5) Hold down the **SHIFT** key and press the **5** key on the R3265A/3271A. When the "Please input password!!" message appears, press **9**, **4**, **2**, **8** **4** in this sequence.

(6) Press the **YTF TUNE** and **YTF SWEEP ON/OFF** keys to set YTF SWEEP to "ON".

[3.5 to 7.5GHz Band]

(7) Press the following keys on the R3265A/3271A:

BAND SELECT **2** **Hz** **SPAN** **0** **Hz**

(8) Press the **CENTER** **3** **.** **7** and **GHz** keys in this sequence.

(9) Set the **CW** to 3.7 GHz on the sweeper.

(10) Press the **YTF OFFSET** key on the R3265A/3271A, and adjust the data control so that the peak of band-pass filter waveforms locates within the center scale position ± 0.5 div on the screen.

(11) Set the **CW** to 7.4 GHz on the sweeper.







(12) Press the **CENTER** **7** **.** **4** and **GHz** keys on the R3265A/3271A.



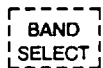

- (13) Press the  key on the R3265A/3271A, and adjust the data control so that the peak of band-pass filter waveforms locates within the center scale position ± 0.5 div on the screen.
- (14) Repeat Steps (8) to (13) so that the YTF OFFSET and YTF GAIN reach within the center scale position = ± 0.5 div.

Caution: Skip Steps (15) to (22) for the R3271A. Jump to Step (23).

[7.4 to 8GHz band (R3265A only)]

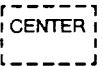



- (15) Press the following keys on the R3265A in this sequence.

   ,   

- (16) Press the  ,   and  keys in this sequence.

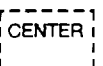
- (17) Set the  to 7.6 GHz on the sweeper.

- (18) Press the  key on the R3265A, and adjust the data control so that the peak of band-pass filter waveforms locates within the center scale position ± 0.5 div.

- (19) Press the  ,   and  keys on the R3265A in this sequence.

- (20) Set the  to 8.3 GHz on the sweeper.





- (21) Press the  key on the R3265A, and adjust the data control so that the peak of band-pass filter waveforms locates within the center scale position ± 0.5 div.



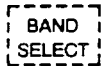

- (22) Repeat Steps (16) to (21) so that both the YTF OFFSET and YTF GAIN locate within the center scale position ± 0.5 div.

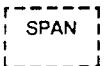
Caution: Skip Steps (23) to (46) for the R3265A. Jump to Step (47).



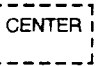



[7.4 to 15.4GHz band (R3271A only)]

- (23) Press the following keys on the R3271A in this sequence.

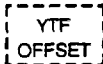
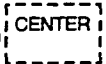
   ,   







- (24) Press the  ,   and  keys in this sequence.











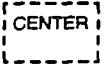

- (25) Set the  to 7.6 GHz on the sweeper.

- (26) Press the  key on the R3271A, and adjust the data control so that the peak of band-pass filter waveforms locates within the center scale position ± 0.5 div.
- (27) Press the , ,  and  keys on the R3271A in this sequence.
- (28) Set the  to 15 GHz on the sweeper.
- (29) Press the  key on the R3271A, and adjust the data control so that the peak of band-pass filter waveforms locates within the center scale position ± 0.5 div.
- (30) Repeat Steps (24) to (29) so that both the YTF OFFSET and YTF GAIN locate within the center scale position ± 0.5 div.

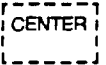
[15.2 to 23.3GHz band (R3271A only)]







- (31) Press the following keys on the R3271A in this sequence.





  ,   

- (32) Press the , ,  and  keys in this sequence.
- (33) Set the  to 16 GHz on the sweeper.
- (34) Press the  key on the R3271A, and adjust the data control so that the peak of band-pass filter waveforms locates within the center scale position ± 0.5 div.
- (35) Press the , ,  and  keys on the R3271A in this sequence.
- (36) Set the  to 23 GHz on the sweeper.
- (37) Press the  key on the R3271A, and adjust the data control so that the peak of band-pass filter waveforms locates within the center scale position ± 0.5 div.
- (38) Repeat Steps (32) to (37) so that both the YTF OFFSET and YTF GAIN locate within the center scale position ± 0.5 div.

[23 to 26.5GHz band (R3271A only)]

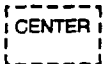
- (39) Press the following keys on the R3271A in this sequence.

  ,   

- (40) Press the , ,  and  keys in this sequence.
- (41) Set the  to 24 GHz on the sweeper.

- (42) Press the key on the R3271A, and adjust the data control so that the peak of band-pass filter waveforms locates within the center scale position ± 0.5 div.
- (43) Press the , , and keys on the R3271A in this sequence.
- (44) Set the to 26 GHz on the sweeper.
- (45) Press the key on the R3271A, and adjust the data control so that the peak of band-pass filter waveforms locates within the center scale position ± 0.5 div.
- (46) Repeat Steps (40) to (45) so that both the YTF OFFSET and YTF GAIN locate within the center scale position ± 0.5 div.

[Data Writing in EEPROM]

- (47) Hold down the key and press the MARKER key on the R3265A/3271A, and wait for approximately 10 seconds. Data writing in the EEPROM will complete.
- (48) Press the , and keys in this sequence.

5.3.8 Frequency Response Adjustment

- ASSEMBLY ADJUSTED
 RF I/O assembly (BLL-017508x01/x02)

- RELATED PERFORMANCE TEST
 Frequency response
 Displayed average noise level

- DESCRIPTION

Enter the RF signals synchronized with the R3265A/3271A sweep signals from the sweeper using the sweep adapter.

Adjust the BAND GAIN and SLOPE GAIN of each band, and adjust the MIXER BIAS for the R3271A band greater than 3.5 GHz. Before the frequency response adjustment, the YTF adjustment has been completed.

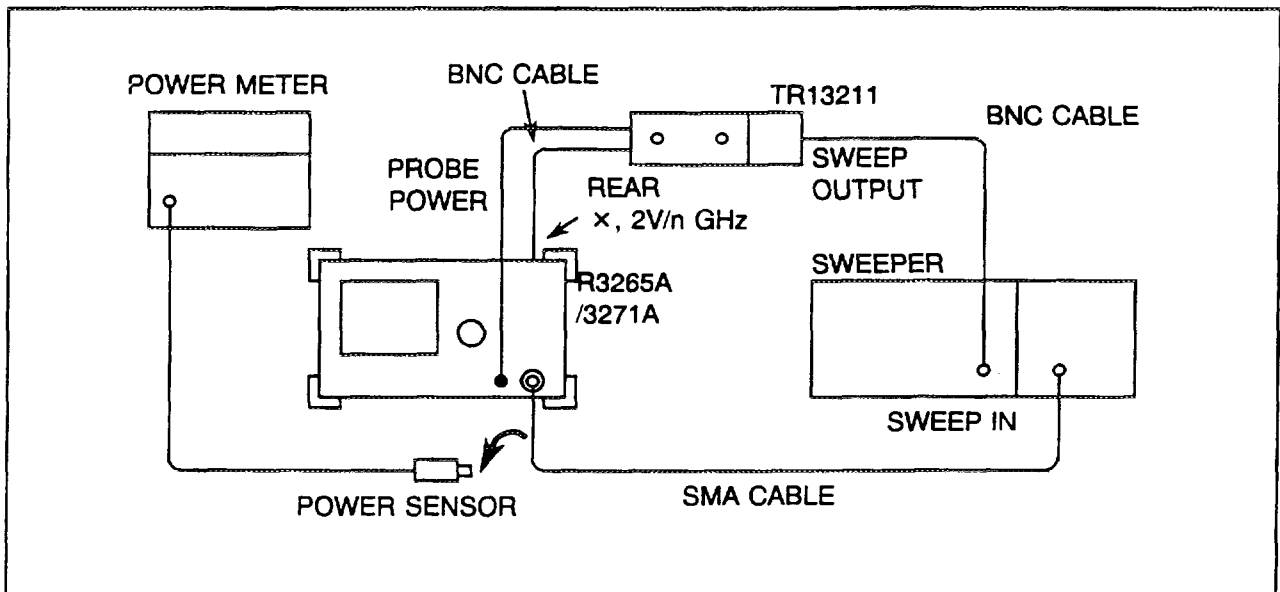

Figure 5-12 Frequency Response Adjustment Setup

- EQUIPMENT

Sweeper:	HP8350 and HP83595A
Sweep adapter:	TR13211
Power meter:	HP436A
Power sensor:	HP8485A
Cable:		
A01002:	SMA (male), 70 cm long
Two MI-09's:	BNC (male), 150 cm long

● PROCEDURE

(1) Zero and calibrate the power meter. Rotate and set the CAL FACTOR control to the 2GHz calibration factor of the power sensor.

(2) Connect the equipment as illustrated in Figure 5-12.

(3) Press the INSTR PRESET key on the HP8350, and set the control as follows:

START FREQ:	10 MHz
STOP FREQ:	3.6 GHz
POWER LEVEL:	-4 dBm
SWEEP:	EXT
SWEEP TRIGGER:	EXT

(4) Press the PRESET key on the R3265A/3271A, and set the controls as follows:

START:	0 MHz
STOP:	3.6 GHz
SWEEP TIME:	500 msec

(5) Set the controls of TR13211 as follows:

FM:	INT
FREQ:	100 Hz
LEVEL:	Center position of variable range

(6) Press the START key on the TR13211, and adjust the START control so that the signal overlaps on the left vertical axis of the screen on the R3265A/3271A.

(7) Press the STOP key on the TR13211, and adjust the STOP control so that the signal overlaps on the right vertical axis of the screen on the R3265A/3271A.

(8) Press the SWEEP key on the TR13211, and fine adjust the START and STOP controls of the TR13211 so that the signals are displayed on the entire R3265A/3271A screen from its leftmost end to the rightmost end. (For the TR13211 operations, refer to the TR13211 operation manual.)

(9) Disconnect the SMA cable from the input terminal of R3265A/3271A, and connect the power sensor to it.

- (10) Press the **MENU** , **SWEEP MODE** , and **SINGLE SWP** keys on the R3265A/3271A, and set the sweep time to 20 seconds.
- (11) Press the **MENU** , **SWEEP MODE** , and **SINGLE SWP** keys on the R3265A/3271A, and measure the frequency characteristics of sweeper output on the power meter. Using the result data, adjust the POWER LEVEL and SLOPE controls of the sweeper so that the frequency characteristics waveforms enter within $-4 \text{ dBm} \pm 1 \text{ dB}$.
- (12) Press the **MENU** , **SWEEP MODE** and **SINGLE SWP** keys on the R3265A/3271A, and repeat Step (11) until the frequency characteristics waveforms enter within $-4 \text{ dBm} \pm 1 \text{ dB}$.
- (13) Press the **SAVE** and **1** keys on the sweeper.
- (14) Disconnect the SMA cable from the power sensor, and connect it to the R3265A/3271A input.
- (15) Press the **MENU** , **SWEEP MODE** , and **CONT SWP** keys on the R3265A/3271A, and set the controls as follows:

SWEEP TIME:	500 msec
START:	3.61 GHz
STOP:	7.5 GHz

Rotate and adjust the CAL FACTOR control of the power meter to the 6GHz calibration factor of power sensor.

- (16) Repeat Steps (6) to (12).
- (17) Press the **SAVE** and **2** keys of the sweeper.
- (18) Disconnect the SMA cable from the power sensor, and connect it to the R3265A/3271A input.

Caution: Skip Steps (19) to (22) for the R3271A. Jump to Step (23).

[R3265A only]

- (19) Press the **MENU**, **SWEEP MODE**, and **CONT SWP** keys on the R3265A, and set the controls as follows:

SWEEP TIME: 500 msec
 START: 7.5 GHz
 STOP: 8.3 GHz

Rotate and adjust the CAL FACTOR control of the power meter to the 6GHz calibration factor of power sensor.

- (20) Repeat Steps (6) to (12).
- (21) Press the **SAVE** and **3** keys of the sweeper.
- (22) Disconnect the SMA cable from the power sensor, and connect it to the R3265A/3271A input.
 Skip Steps (23) to (34), and jump to Step (35).

[R3271A only]

- (23) Press the **MENU**, **SWEEP MODE**, and **CONT SWP** keys on the R3271A, and set the controls as follows:

SWEEP TIME: 500 msec
 START: 7.5 GHz
 STOP: 15.4 GHz

Rotate and adjust the CAL FACTOR control of the power meter to the 12GHz calibration factor of power sensor.

- (24) Repeat Steps (6) to (12).
- (25) Press the **SAVE** and **3** keys of the sweeper.
- (26) Disconnect the SMA cable from the power sensor, and connect it to the R3271A input.

- (27) Press the **MENU**, **SWEEP MODE**, and **CONT SWP** keys on the R3271A, and set the controls as follows:

SWEEP TIME: 500 msec
 START: 15.4 GHz
 STOP: 23.3 GHz

Rotate and adjust the CAL FACTOR control of the power meter to the 20GHz calibration factor of power sensor.

- (28) Repeat Steps (6) to (12).

- (29) Press the **SAVE** and **4** keys of the sweeper.

- (30) Disconnect the SMA cable from the power sensor, and connect it to the R3271A input.

- (31) Press the **MENU**, **SWEEP MODE**, and **CONT SWP** keys on the R3271A, and set the controls as follows:

SWEEP TIME: 500 msec
 START: 23.3 GHz
 STOP: 26.5 GHz

Rotate and adjust the CAL FACTOR control of the power meter to the 25GHz calibration factor of power sensor.

- (32) Repeat Steps (6) to (12).

- (33) Press the **SAVE** and **5** keys of the sweeper.

- (34) Disconnect the cable from the power sensor, and connect it to the R3271A input.

[R3265A/3271A]

- (35) Press the **MENU**, **SWEEP TIME** and **CONT SWEEP** keys on the R3265A/3271A, and set the controls as follows:

START: 10 MHz
 STOP: 3.6 GHz
 SWEEP TIME: 500 msec
 dB/div: 2 dB/div
 DISP LINE -4 dBm

5.3.10 10MHz Frequency Reference Adjustment

- ASSEMBLY ADJUSTED

Frequency reference assembly (WBL-32xxSTD)

- RELATED PERFORMANCE TEST

Frequency readout accuracy and frequency counter marker accuracy

Frequency reference output accuracy

- DESCRIPTION

Connect the signal cable between the 10MHz terminal of the Frequency Standard unit and the Frequency Comparator unit. Also, connect the cable between the 10MHz REF OUT terminal at the rear panel of R3265A/3271A and the Frequency Comparator unit. Adjust the internal crystal oscillator of the R3265A/3271A.

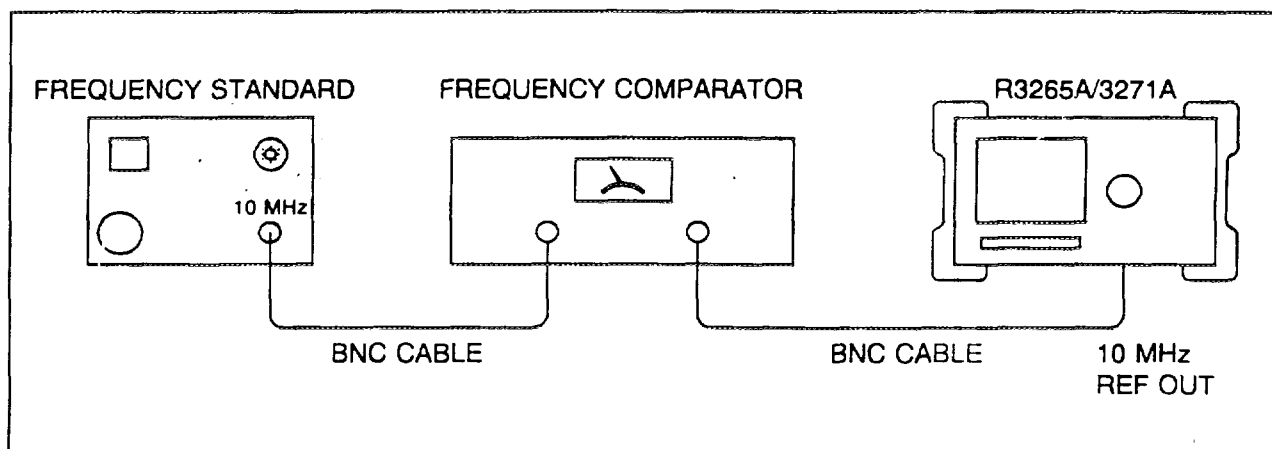

Figure 5-14 10 MHz Frequency Reference Adjustment Setup

- EQUIPMENT

Frequency Standard unit: TR3110

Frequency comparator (supporting 10MHz, 1×10^{-9} signal detection)

Cables:

Two MI-09 cables with BNC (male), 150 cm long

(47) Press the **RECALL_n** and **3** keys on the sweeper.

(48) Repeat Steps (39) to (41).

(49) Jump to Step (62) for data writing in the EEPROM.

[R3271A only]

(50) Press the following keys in this sequence on the R3271A.

BAND SELECT **3** **Hz** **START** **7** **.** **5** **GHz**

(51) Press the **RECALL_n** and **3** keys on the sweeper.

(52) Repeat Steps (39) to (41).

(53) Press the **BIAS ADJ FIX/NAR** key on the R3271A, and adjust the data control so that the entire frequency characteristics curve reaches its peak level. If the frequency characteristics change, repeat Steps (40) and (41).

(54) Press the following keys in this sequence on the R3271A.

BAND SELECT **4** **Hz** **START** **1** **5** **.** **4** **GHz**

(55) Press the **RECALL_n** and **4** keys on the sweeper.

(56) Repeat Steps (39) to (41).

(57) Press the **BIAS ADJ FIX/NAR** key on the R3271A, and adjust the data control so that the entire frequency characteristics curve reaches its peak level. If the frequency characteristics change, repeat Steps (40) and (41).

(58) Press the following keys in this sequence on the R3271A.

BAND SELECT **5** **Hz** **START** **2** **3** **.** **3** **GHz** **STOP** **2** **6** **.** **5** **GHz**

(59) Press the **RECALL_n** and **5** keys on the sweeper.

(60) Repeat Steps (39) to (41).

(61) Press the **BIAS ADJ FIX/NAR** key on the R3271A, and adjust the data control so that the entire frequency characteristics curve reaches its peak level. If the frequency characteristics change, repeat Steps (40) and (41).

[Data writing in the EEPROM]

Caution: The original data is all erased from the EEPROM when data is written in it.

(62) Hold down the SHIFT key and press the ON key on the R3265A/3271A, and wait for approximately 10 seconds. The data will be written in the EEPROM.

(63) Press the RETURN key twice.

5.3.9 Calibrator Amplitude Adjustment

- ASSEMBLY ADJUSTED
WBL-32xxSYN (Synthesizer block)
- RELATED PERFORMANCE TEST
Calibration amplitude accuracy
- DESCRIPTION
The CALOUT amplitude is adjusted for -10.00 dBm measured directly at the front panel CALOUT jack.

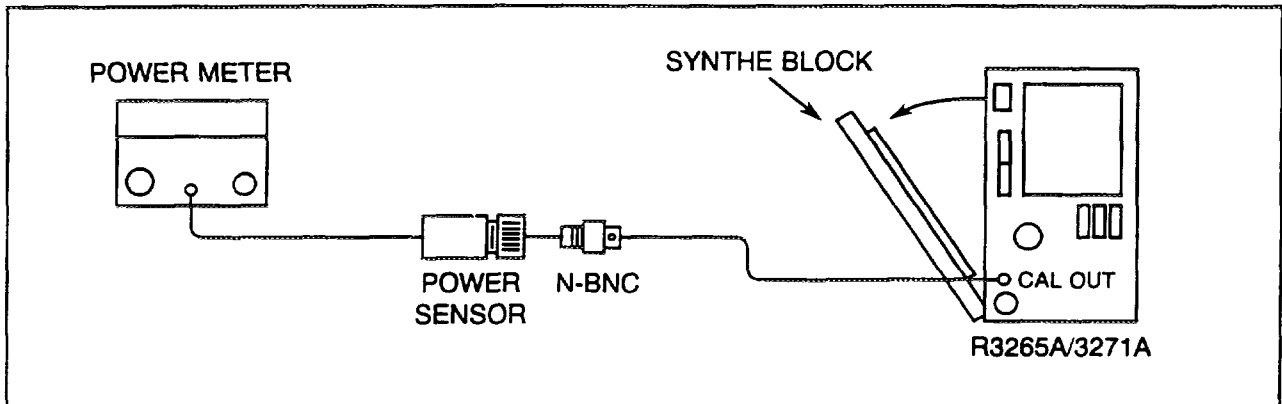

Figure 5-13 Calibrator Amplitude Adjustment Setup

- EQUIPMENT

Power meter:	HP436A
Power sensor:	HP8481A
Adapter		
Type N (female) to BNC (male):	NJ-BNCP
- PROCEDURE
 - (1) Turn off the POWER switch of the R3265A/3271A, and disconnect the power cord. Remove the analyzer cover, place the analyzer as shown in Figure 5-13, and fold down the SYNTH BLOCK assembly.
 - (2) Turn on the POWER switch of R3265A/3271A, and warm it up at least 30 minutes before starting adjustment.
 - (3) Zero and calibrate the power meter in the Log Display mode. Enter the 25MHz CAL FACTOR signal of the power sensor to the power meter.
 - (4) Connect the R3265A/3271A through an N-BNC adapter directly to the CALOUT jack on the R3265A/3271A front panel.

- (5) Adjust R151 of the SYNTH block for a -10.00 dBm reading on the power meter display.

5.3.10 10MHz Frequency Reference Adjustment

- ASSEMBLY ADJUSTED
Frequency reference assembly (WBL-32xSTD)
- RELATED PERFORMANCE TEST
Frequency readout accuracy and frequency counter marker accuracy
Frequency reference output accuracy
- DESCRIPTION
Connect the signal cable between the 10MHz terminal of the Frequency Standard unit and the Frequency Comparator unit. Also, connect the cable between the 10MHz REF OUT terminal at the rear panel of R3265A/3271A and the Frequency Comparator unit. Adjust the internal crystal oscillator of the R3265A/3271A.

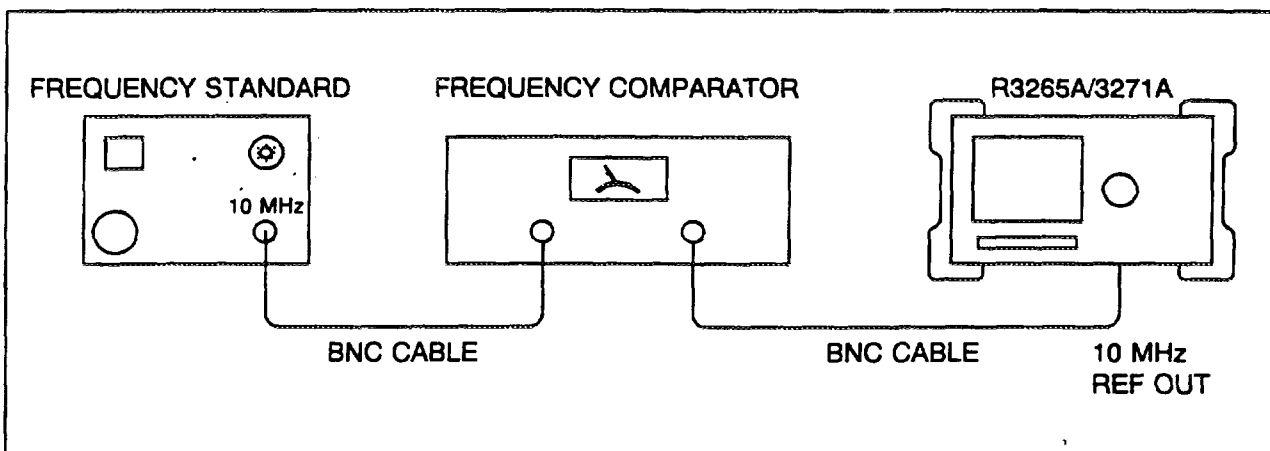

Figure 5-14 10 MHz Frequency Reference Adjustment Setup

- EQUIPMENT
Frequency Standard unit: TR3110
Frequency comparator (supporting 10MHz, 1x10⁻⁹ signal detection)
Cables:
Two MI-09 cables with BNC (male), 150 cm long

- PROCEDURE

NOTE

Allow the R3265A/3271A warm up for at least 30 minutes before performing this adjustment.

- Connect the equipment as shown in Figure 5-14.
- Set the 10MHz REF of the R3265A/3271A to INT.

Press the **CENTER FREQ** and set the **10MHz REF INT/EXT** to INT.

NOTE

When the 10MHz reference is set to EXT, the crystal oscillator is not operating nor warmed up. If the reference is set to EXT, set the reference to INT and allow 30 minutes for the crystal oscillator warm up.

- Hold down the **SHIFT** key and press the **CAL 7** key to select the **CAL FREQ REF**. Then, adjust the data control so that the frequency comparator indicates the value within $\pm 1 \times 10^{-8}$.
- Press the **Hz** key to store the adjusted data.

NOTE

If the adjusted data is within ± 100 but if it cannot be adjusted, set the data to zero and directly adjust the 10MHz reference crystal oscillator as follows.

- Adjust the data control to set the data to zero, and press the **Hz** key to store the data.
- Turn off the **POWER** switch of the R3265A/3271A, and disconnect the power cord and signal cables. Remove the analyzer cover, and fold down the WBL-32xSYN synthesizer block.

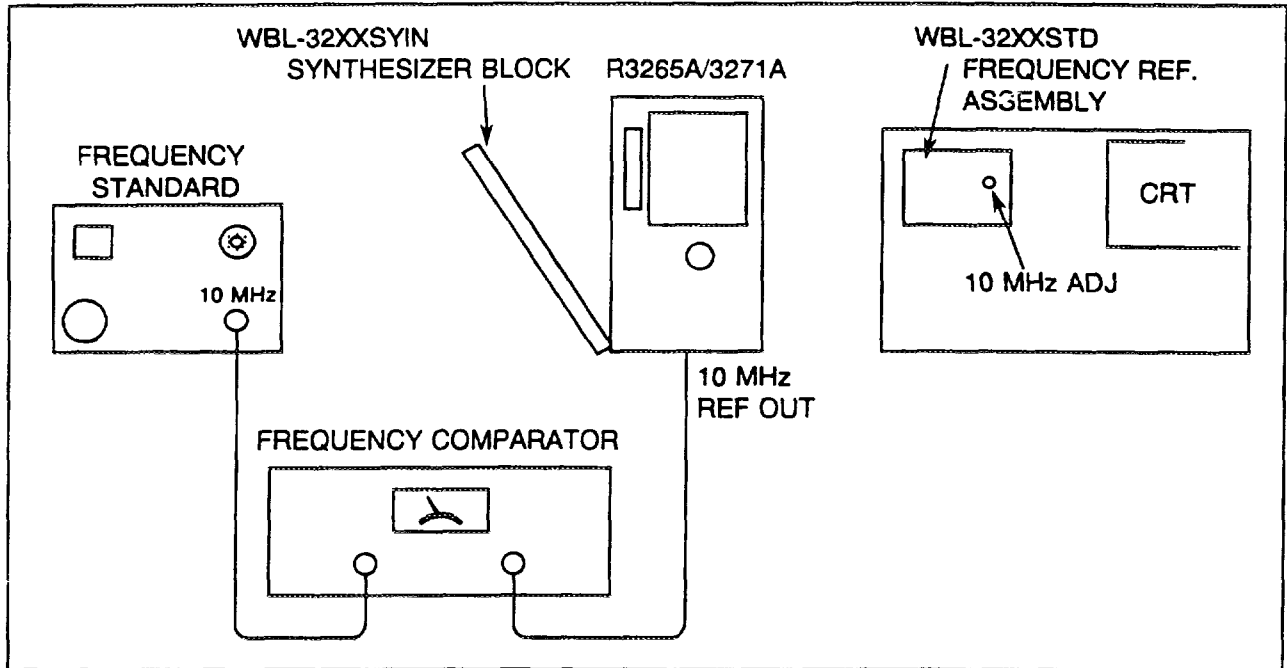

Figure 5-15 10 MHz Reference Crystal Oscillator Adjustment

- (7) Connect the equipment as shown in Figure 5-15.
- (8) Adjust the 10MHz ADJ control of the WBL-32xxSTD unit so that the indicator of frequency comparator reaches within $\pm 1 \times 10^{-8}$.

NOTE

Allow the R3265A/3271A warmup for at least 30 minutes before performing this adjustment.

5.3.11 Frequency Span Adjustment

- ASSEMBLY ADJUSTED
 WBL-3265 I/O
 WBL-3271 I/O
- RELATED PERFORMANCE TEST
 Frequency span accuracy
- DESCRIPTION
 Adjust the frequency span to have an appropriate Span Adjust DAC value of the WBL-3265 I/O (or WBL-3271 I/O).

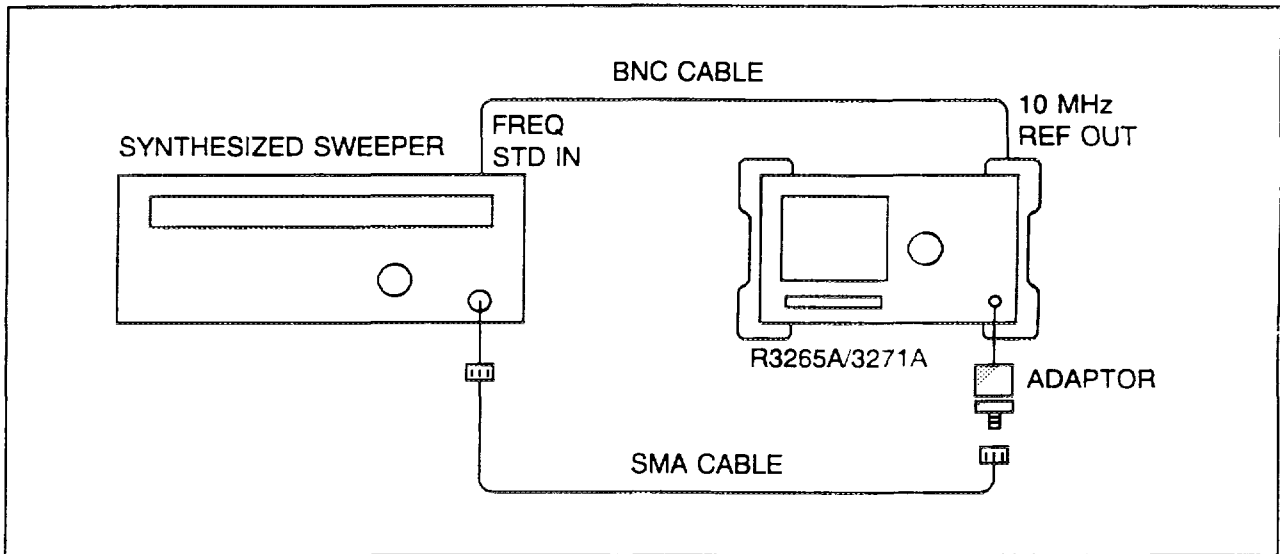

Figure 5-16 SPAN Adjustment Setup

- EQUIPMENT
 - Synthesized sweeper: TR4515
 - Adapter:
 - HTM-554S; Type N (male) to SMA (female)
 - Cables:
 - A01002; SMA (male), 70 cm long
 - MI-09; BNC (male), 150 cm long

● PROCEDURE

(1) Connect the equipment as shown in Figure 5-16.

(2) Set the TR4515 controls as follows:

CW: 3.25 GHz
 OUTPUT POWER: -20 dBm

(3) Press the **PRESET** key on the R3265A/3271A, and set the controls as follows:

START FREQ: 100 MHz
 STOP FREQ: 3.6 GHz
 REF LEVEL: -10 dBm

(4) Press the **PEAK** and **NEXT MENU** keys to set the **CONT PK ON/OFF** to ON.

(5) Hold down the **SHIFT** key and press the **5** key, enter "94284" for password, and select the MAINTENANCE mode.

(6) Hold down the **SHIFT** key and press the **SPAN** key, and the following software menu will appear on the CRT screen.

-----		-----
LIN	-----	CENTER
-----		-----
LOG	-----	SPAN
-----	START	-----
	STOP	START
	-----	-----
	LOG GAIN	STOP
	-----	-----
	LOG	SPAN
	OFFSET	ADJ
	-----	-----
	RETURN	RETURN
	-----	-----

NOTE

Once the MAINTENANCE mode is selected, each function can be set by software keys only.

- (7) Press the **[LIN]** and **[SPAN ADJ]** keys, and adjust the data control to have the marker indication of 3.250 GHz \pm 10 MHz.
- (8) Set the SYNTHESIZER SWEEPER frequency and the **[START]** and **[STOP]** frequencies of the R3265A/3271A as defined on Table 5-3. Adjust the **[SPAN ADJ]** control to have the marker frequency within the limit given on the table.
- (9) Hold down the **[SHIFT]** key and press the MARKER **[ON]** key to write the adjusted data in the EEPROM.

Table 5-3 Span Adjustment

TR4515 Frequency	R3265A/3271A		Marker Indication	
	START Frequency	STOP Frequency	MIN	MAX
3.25 GHz	100 MHz	3.6 GHz	3.240 GHz	3.260 GHz
7.3 GHz	100 MHz	8.1 GHz	7.280 GHz	7.320 GHz
460 MHz	100 MHz	500 MHz	458 MHz	462 MHz
136 MHz	100 MHz	140 MHz	135.8 MHz	136.2 MHz
109 MHz	100 MHz	110 MHz	108.95 MHz	109.05 MHz
101.8 MHz	100 MHz	102 MHz	101.79 MHz	101.81 MHz
100.36 MHz	100 MHz	100.4 MHz	100.358 MHz	100.362 MHz
100.018 MHz	100 MHz	100.02 MHz	100.0179 MHz	100.0181 MHz

[LOG SPAN Adjustment]

- (10) Press the **[RETURN]** and **[LOG]** keys.
- (11) Press the following keys in this sequence.
- [START]** **[1]** **[MHz]** **[STOP]** **[1]** **[GHz]**
- (12) Set the synthesized sweeper frequency to 10 MHz.
- (13) Press the **[LOG OFFSET]** key and adjust the data control to have the marker frequency of 10 \pm 0.1 MHz.
- (14) Set the synthesized sweeper frequency to 900 MHz.
- (15) Press the **[LOG GAIN]** key and adjust the data control to have the marker frequency of 900 \pm 10 MHz.

- (16) Repeat Steps (12) to (15), and adjust the data control so that the marker frequency comes within the limit defined on Table 5-4.
- (17) Set the synthesized sweeper frequency and the **[START]** and **[STOP]** frequencies of R3265A/3271A to the values defined on Table 5-4, and repeat Steps (12) to (15).
- (18) Hold down the **[SHIFT]** key and press the **[ON]** key to write the adjusted data in the EEPROM.

Table 5-4 LOG SPAN Adjustment

R3265A/3271A		Adjustment.	TR4515 Frequency	Marker Indication	
START FREQ.	STOP FREQ.			MIN	MAX
1 MHz	1 GHz	LOG OFFSET	10 MHz	9.9 MHz	10.1 MHz
		LOG GAIN	900 MHz	890 MHz	910 MHz
10 MHz	1 GHz	LOG OFFSET	20 MHz	19.8 MHz	20.2 MHz
		LOG GAIN	900 MHz	890 MHz	910 MHz
100 MHz	1 GHz	LOG OFFSET	200 MHz	198 MHz	202 MHz
		LOG GAIN	900 MHz	890 MHz	910 MHz

5.3.12 Sample Synthesizer Adjustment

- ASSEMBLY ADJUSTED

Synthesizer block (WBL-32xxSYN)

- RELATED PERFORMANCE TEST

There is no related performance test.

- DESCRIPTION

The doubler of the sample synthesizer must be adjusted using the variable resistor to suppress spurious.

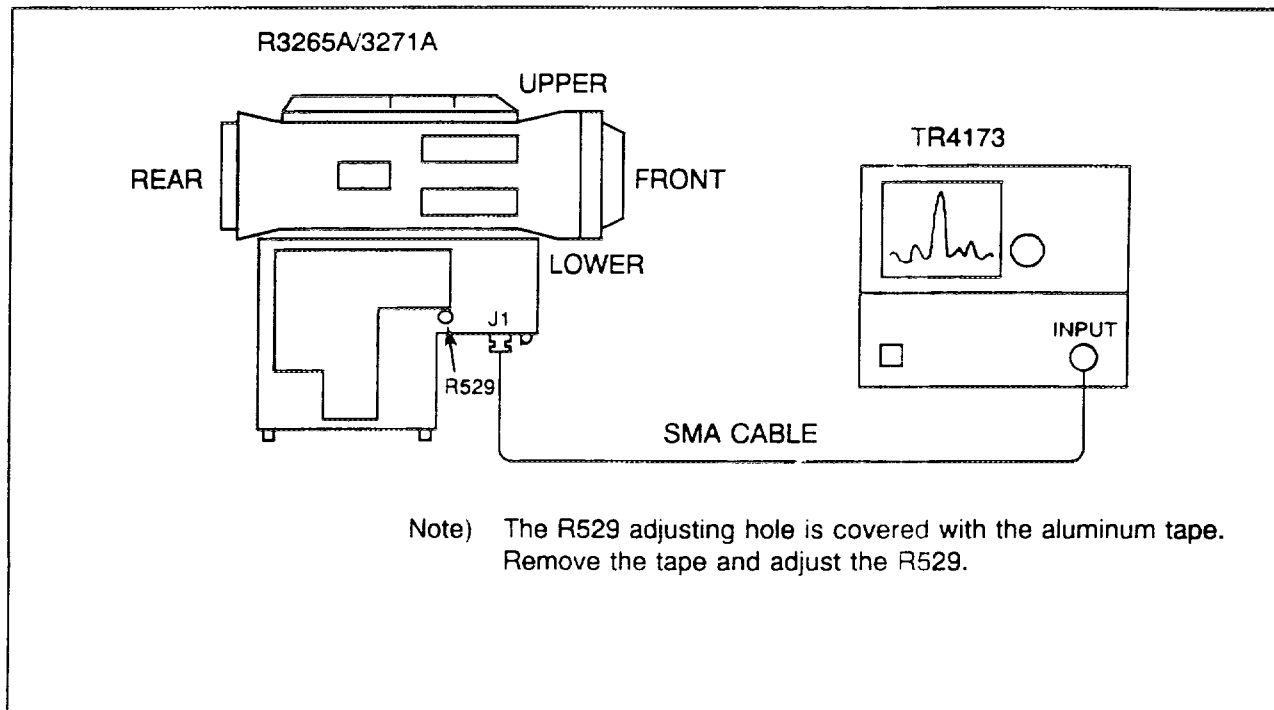

Figure 5-17 Sampler Synthe Adjustment

- EQUIPMENT

Spectrum analyzer: TR4173

Cable:

A01002; SMA (male), 70 cm long

- PROCEDURE

- (1) Remove the cover from the system.
- (2) Remove three screws from the synthesizer board.
- (3) Unplug the SMA connector from J1.

- (4) Connect the SMA cable between J1 and TR4173 (see Figure 5-17).
- (5) Turn on the POWER switch of R3265A/3271A, and set the controls as follows:

CENTER FREQ:	40 MHz
SPAN:	10 MHz
- (6) Set the TR4173 controls as follows:

CF:	3985 MHz
SPAN:	10 MHz
REF:	-20 dBm
RBW:	10 kHz
VBW:	300 kHz
- (7) Make sure that the carrier exists at the center of TR7143 waveforms, and adjust the R529 so that the side signal amplitude is 55 dBc or more.
- (8) Unplug the SMA cable from J1, and plug the original cable.

5.3.13 EXT Mixer Adjustment

- ASSEMBLY ADJUSTED
RF I/O assembly (BLL-017508x01/x02)

- RELATED PERFORMANCE TEST
There is no related performance test.

- DESCRIPTION
Enter the 421.42MHz signals of the IF frequency of external (EXT) mixer to the first Lo OUT terminal, and adjust the BAND GAIN control of the EXT mixer band.

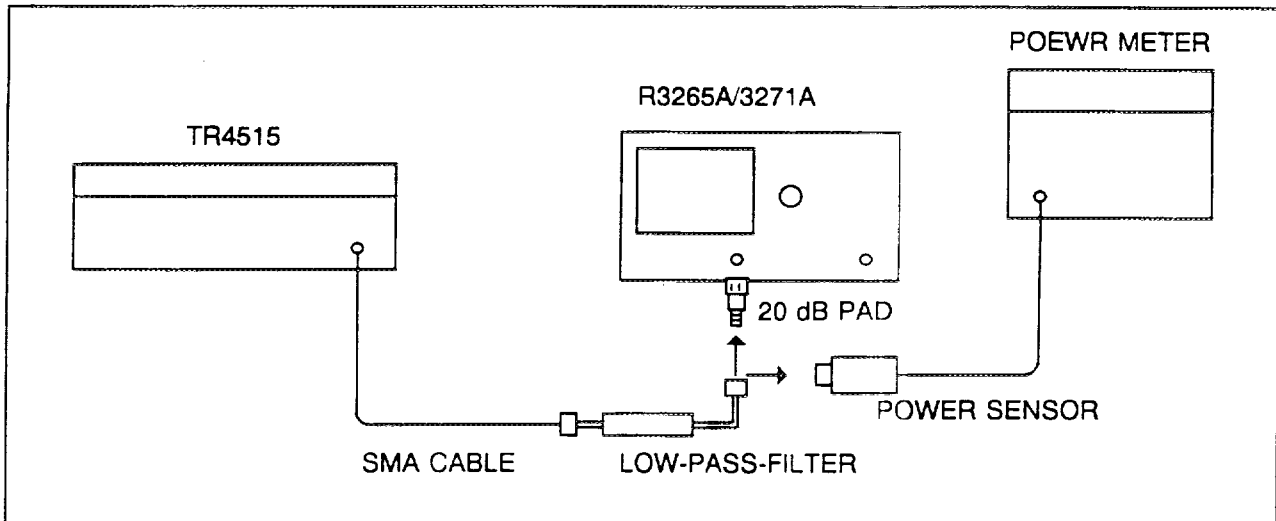

Figure 5-18 Frequency Response Adjustment (2) Setup

- EQUIPMENT

Synthesized sweeper:	TR4515
Power meter:	HP436A
Power sensor:	HP8485A or HP8481A
2GHz low-pass filter:	DEE-001172-1
20dB PAD:	DEE-000480-1
Adapter:	
HRM-501;	SMA (female) to SMA (female)
Cable:	
A01002;	SMA (male)

● PROCEDURE

- (1) Zero and calibrate the power meter. Rotate and adjust the CAL FACTOR control to set the 421MHz calibration factor of the power sensor.
- (2) Connect the equipment as illustrated in Figure 5-18. However, connect the low-pass filter output to the power sensor.

(3) Press the **PRESET** key of the TR4515, and set the controls as follows:

CW: 421.42 MHz
 POWER LEVEL: -5 dBm

- (4) Adjust the POWER LEVEL of the TR4515 so that the power meter indicates -5 dBm.
- (5) Connect the low-pass filter output to the 20dB PAD, and connect to the 1st Lo OUT terminal of the R3265A/3271A.

(6) Press the **PRESET** and **CENTER FREQ** keys on the R3265A/3271A to set the **MIX EXT** .

(7) Hold down the **SHIFT** key and press the **5** key on the R3265A/3271A. When the "Please input password!!" message appears, enter "94284" for the password. Then, press the **MIX TUNE** key.

(8) Press the following keys and adjust the DATA control so that the signals appear on a horizontal line on the screen when they reach within 1 dB from the top of the screen.

BAND SELECT **1** **0** **Hz** **SLOPE GAIN** **0** **Hz** **BAND GAIN**

[Data writing in EEPROM]

Caution: The original data is all erased from the EEPROM when data is written in it.

(9) Hold down the **SHIFT** key and press the **MARKER ON** key on the R3265A/3271A, and wait for approximately 10 seconds. The data will be written in the EEPROM.

(10) Press the **RETURN** key twice.

ADVANTEST product is warranted against defects in material and workmanship for a period of one year from the date of delivery to original buyer.

LIMITATION OF WARRANTY

The foregoing warranty shall not apply to defects resulting from improper or inadequate maintenance by buyer, unauthorized modification or misuse, accident or abnormal conditions of operations.

No other warranty is expressed or implied. ADVANTEST specifically disclaims the implied warranties of merchantability and fitness for a particular purpose.

ADVANTEST shall not be liable for any special incidental or consequential damages, whether in contract, tort or otherwise.

Any and all warranties are revoked if the product is removed from the country in which it was originally purchased.

SERVICE

During the warranty period, ADVANTEST will, at its option, either repair or replace products which prove to be defective.

When trouble occurs, buyer should contact his local supplier or ADVANTEST giving full details of the problem and the model name and serial number.

For the products returned to ADVANTEST for warranty service, buyer shall prepay shipping and transportation charges to ADVANTEST and ADVANTEST shall pay shipping and transportation charges to return the product to buyer. However, buyer shall pay all charges, duties, and taxes incurred in his country for products returned from ADVANTEST.

CLAIM FOR DAMAGE IN SHIPMENT TO ORIGINAL BUYER

The product should be thoroughly inspected immediately upon original delivery to buyer. All material in the container should be checked against the enclosed packing list or the instruction manual alternatively. ADVANTEST will not be responsible for shortage unless notified immediately.

If the product is damaged in any way, a claim should be filed by the buyer with carrier immediately. (To obtain a quotation to repair shipment damage, contact ADVANTEST or the local supplier.) Final claim and negotiations with the carrier must be completed by buyer.

SALES & SUPPORT OFFICES

Advantest America, Inc.
300 Knightsbridge Parkway Suite 200, Lincolnshire,
IL 60069 U.S.A.
Phone (708)634-2552
Facsimile (708)634-2872

Advantest UK Limited
CI Tower, St. Georges Square, High Street,
New Malden Surrey, KT3 1HH The United Kingdom
Phone (081)336-1606
Facsimile (081)336-1657

Advantest (Singapore) Pte. Ltd.
150 Beach Road, #01-00
Gateway West Singapore 0718
Phone (65)299-4268
Facsimile (65)299-4226

Advantest Giga S.A.
5, Av du Quebec Z.A. de Courtaboeuf
B.P.203-91941 Les Ulis Cedex, France
Phone (331)6918-2500
Facsimile (331)6982-9224

ADVANTEST®
ADVANTEST CORPORATION